

A	B	C	D	
1	S89-001	546	446	2/2
2	S89-104	418	325	1/2
3	S89-105	418	325	1/2
4	S89-107	418	325	1/2
5	S89-108	418	325	1/2
6	S89-204	1650	325	1/2
7	S89-304	528	325	1/2
8	S89-9901	545	443	1/2
9	S89-9902	545	443	1/2

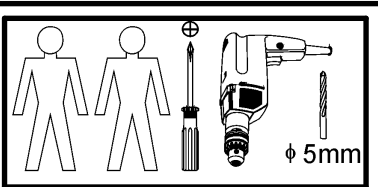

6x a58	4x b22	2x b24	3x c250	12x $\phi 5 \times 17$ mm d1	16x $\phi 8 \times 30$ mm f1	8x $\phi 10 \times 50$ mm f35	6x M4x28 mm j11	70x l1
4x n10	4x n9	8x $\phi 5 \times 60$ mm p17	8x $\phi 4 \times 30$ mm p21	12x $\phi 3.5 \times 15$ mm p51	16x $\phi 1.5 \times 12$ mm #16 r1	16x r16	16x $\phi 16$ s2	

# 1

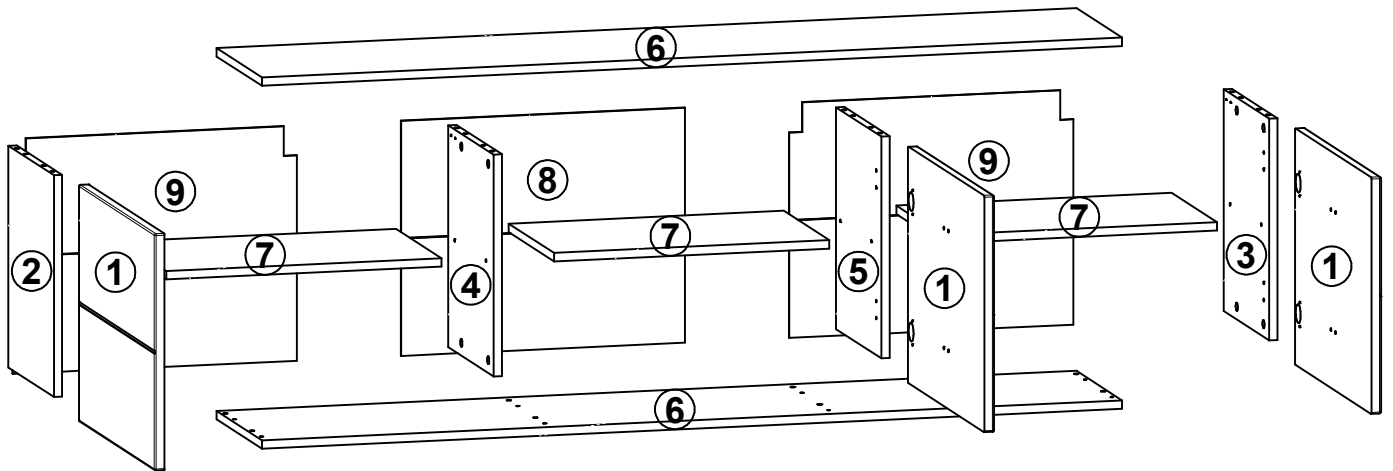
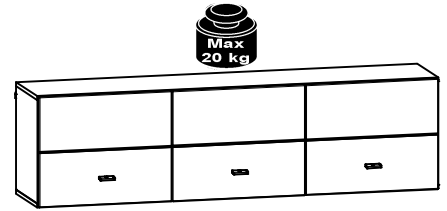
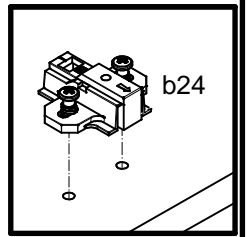
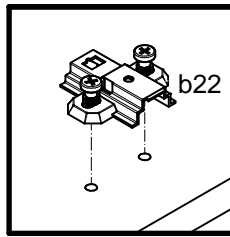
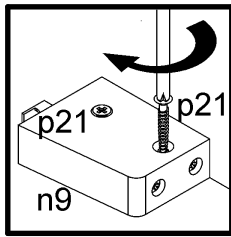
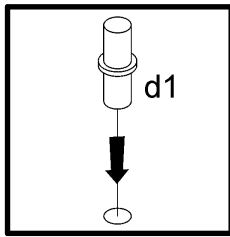
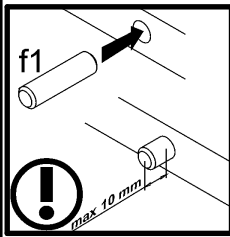
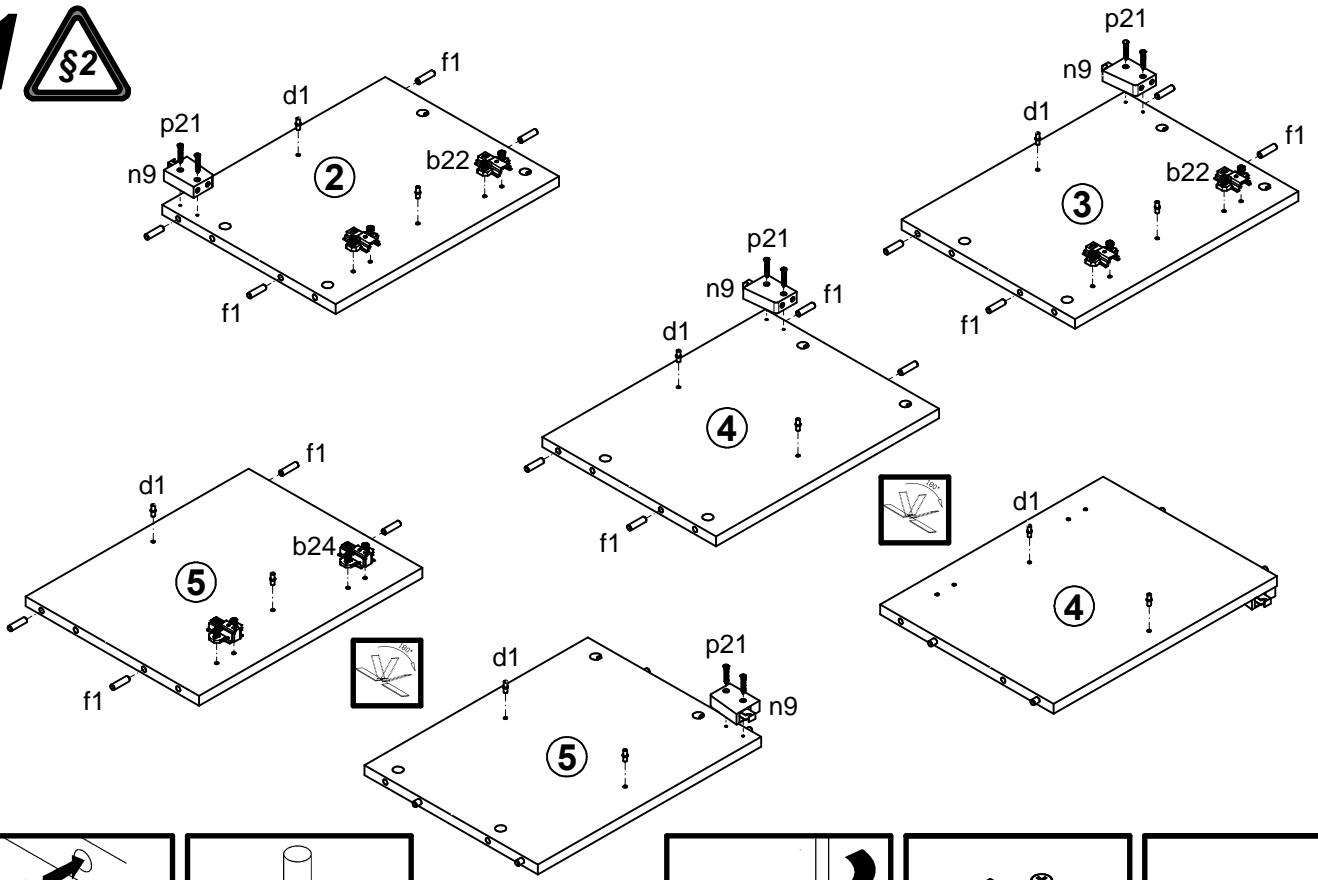

# 2

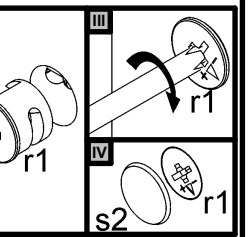
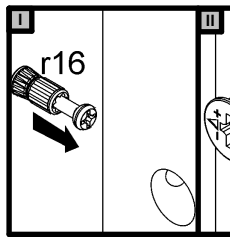
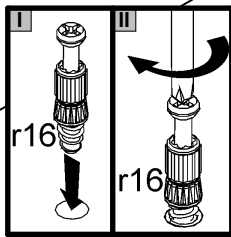
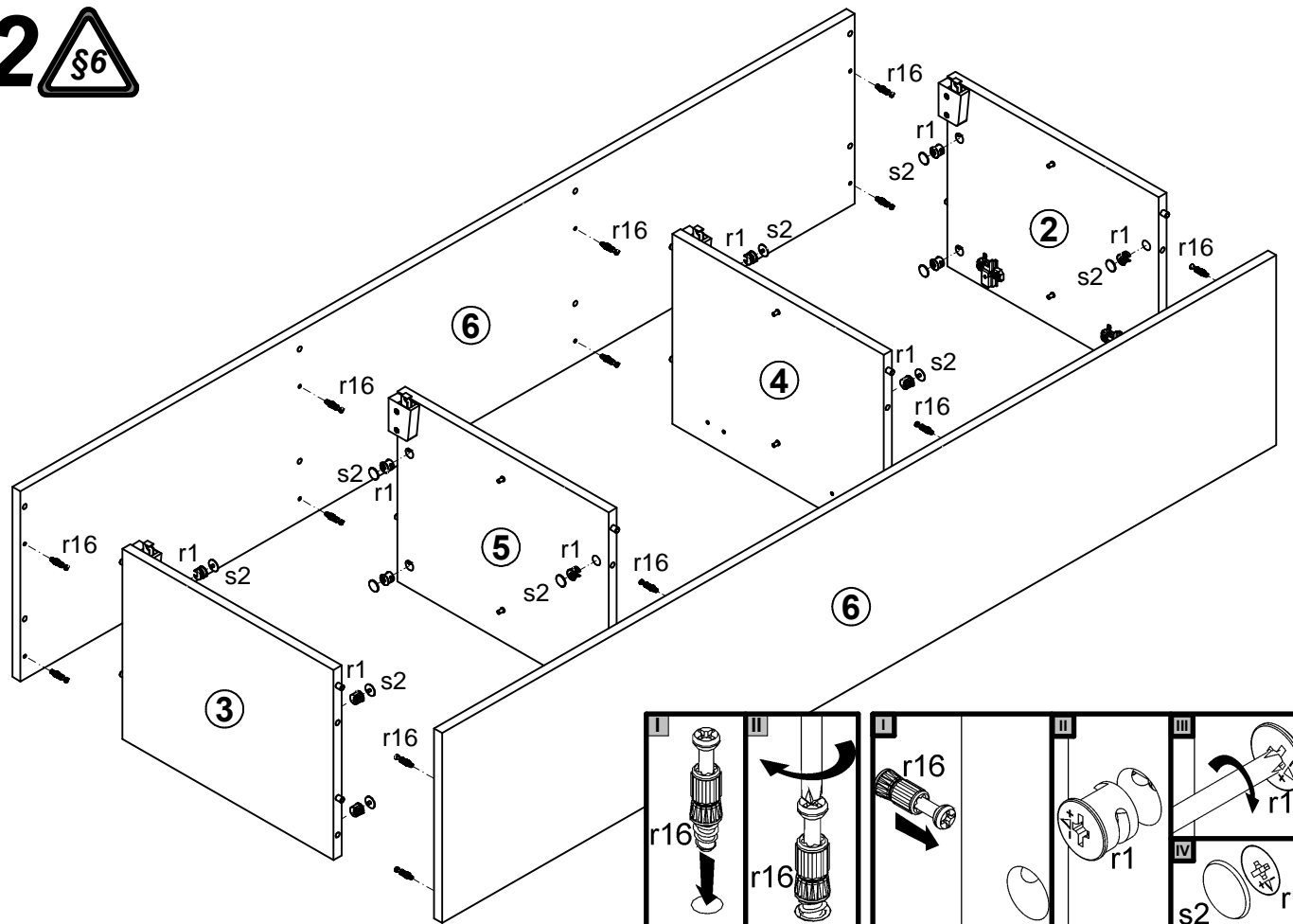

# 3

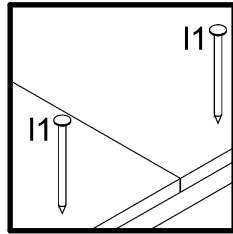
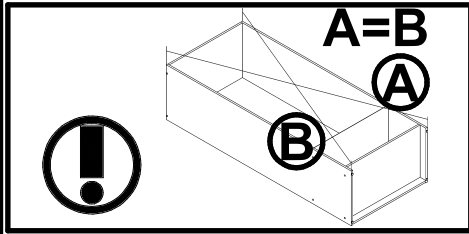
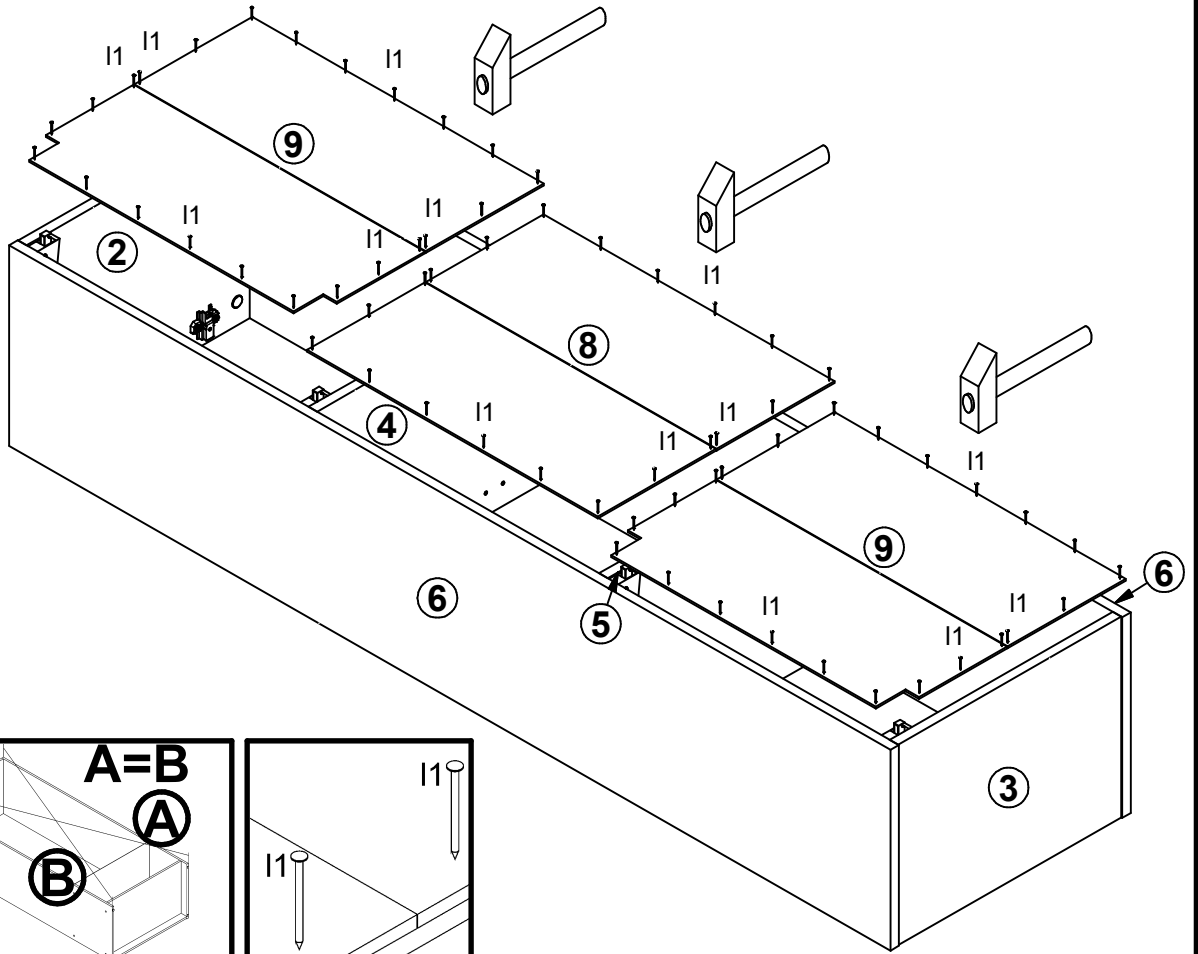

# 4

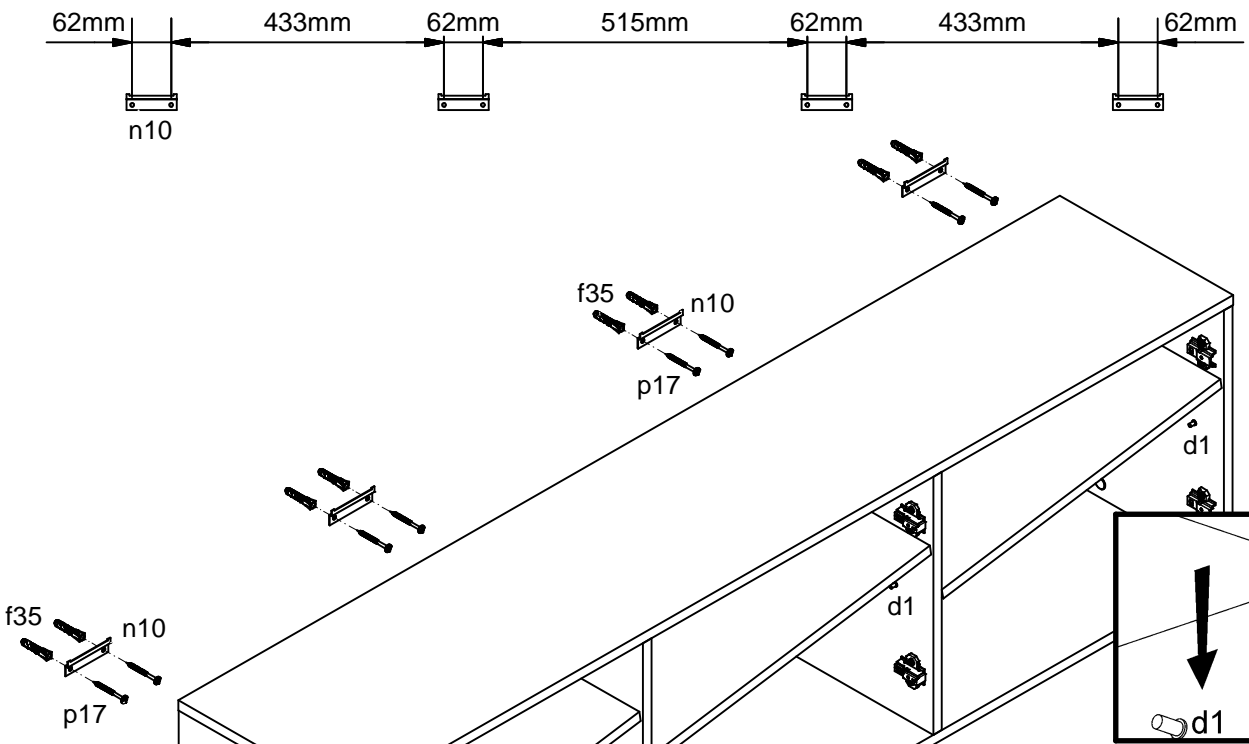

$\phi 10$  mm

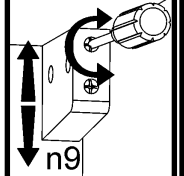
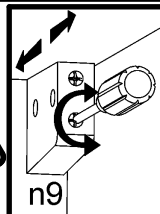
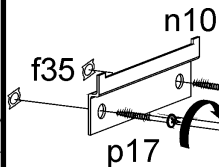
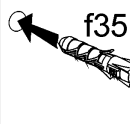

# 5

