

A	B	C	D
1	S92-006	912	496
2	S92-007	696	225
3	S92-112	902	400
4	S92-113	902	400
5	S92-114	902	396
6	S92-115	902	396
7	S92-208	1700	420
8	S92-209	1700	400
9	S92-305	475	396
10	S92-507	350	160
11	S92-508	350	160
12	S92-509	644	146
13	S92-907	654	356
14	S92-9901	922	493
15	S92-9902	922	699

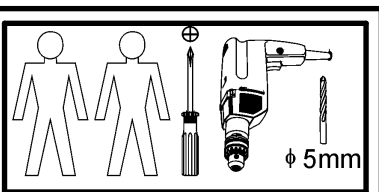

4x a44	4x b35	4x c253\1	2x c253\2	16x d1	32x e3	16x f1	16x f25	8x k55
105x l1	4x p25	4x p35	16x p38	8x p51	16x p6	16x p9	16x r1	16x r15
32x r16	4x t35	4x w44\L	4x w44\P	16x s2	1x n26\1	1x p38		

# 1

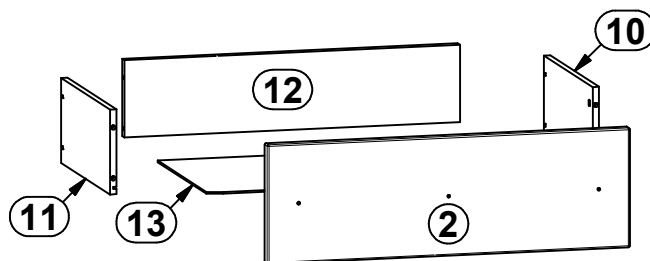
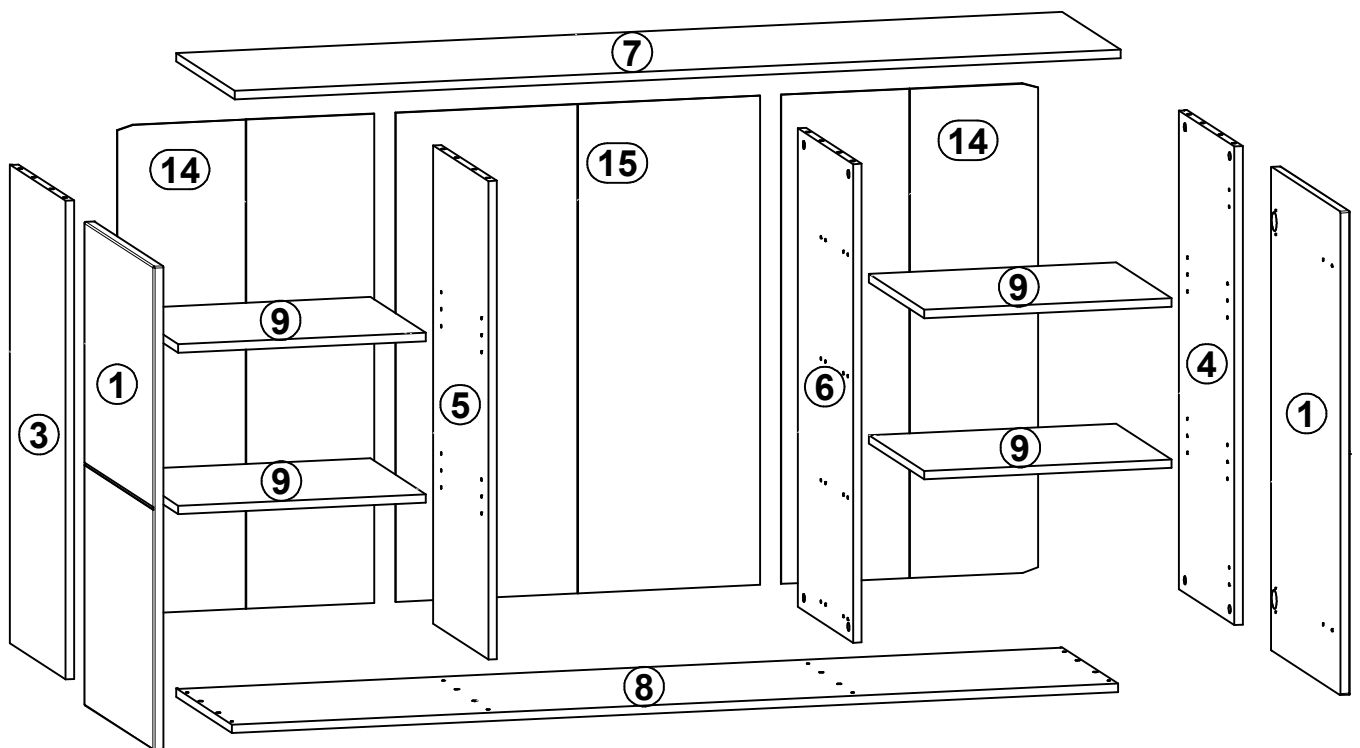
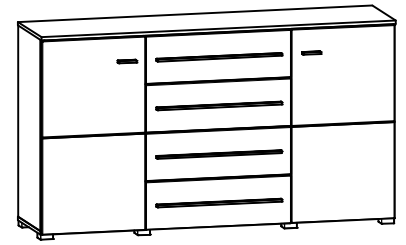
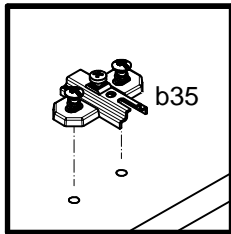
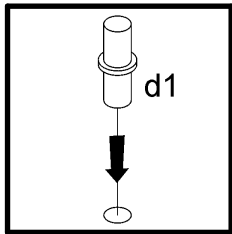
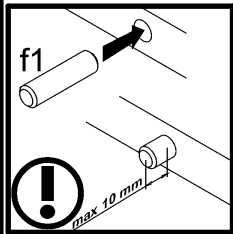
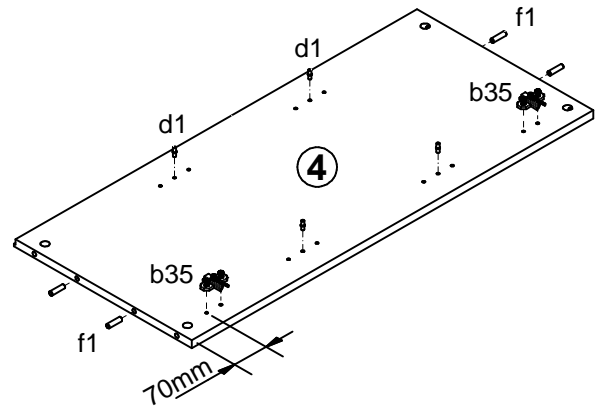
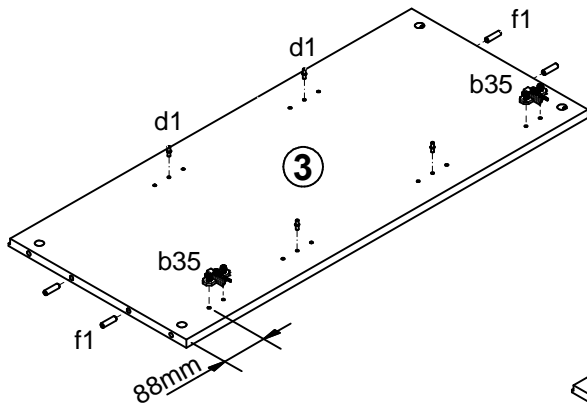

# 2

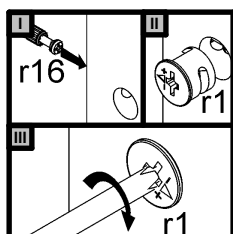
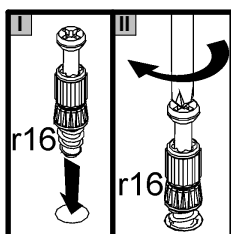
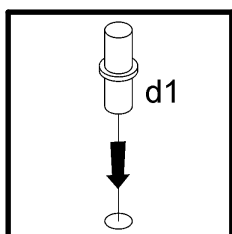
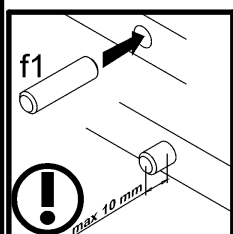
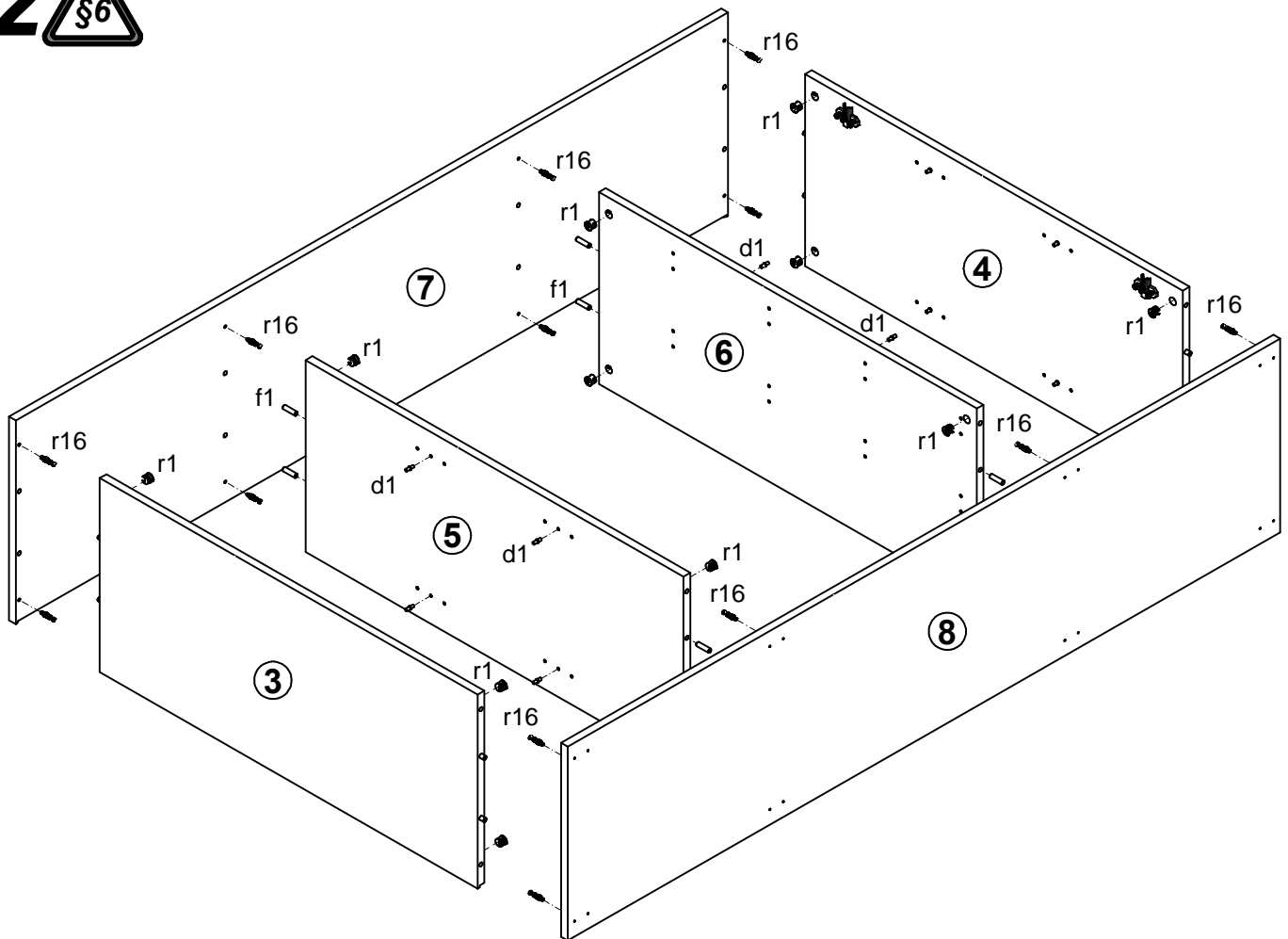

# 3

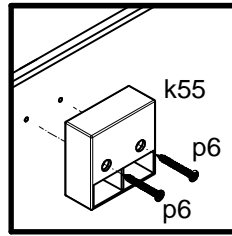
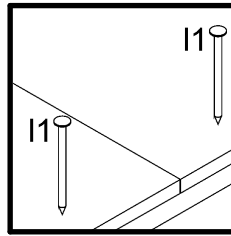
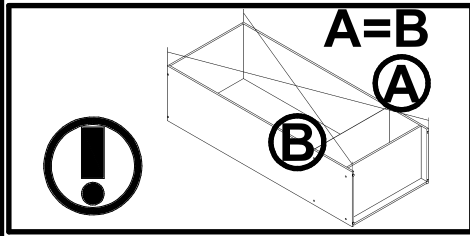
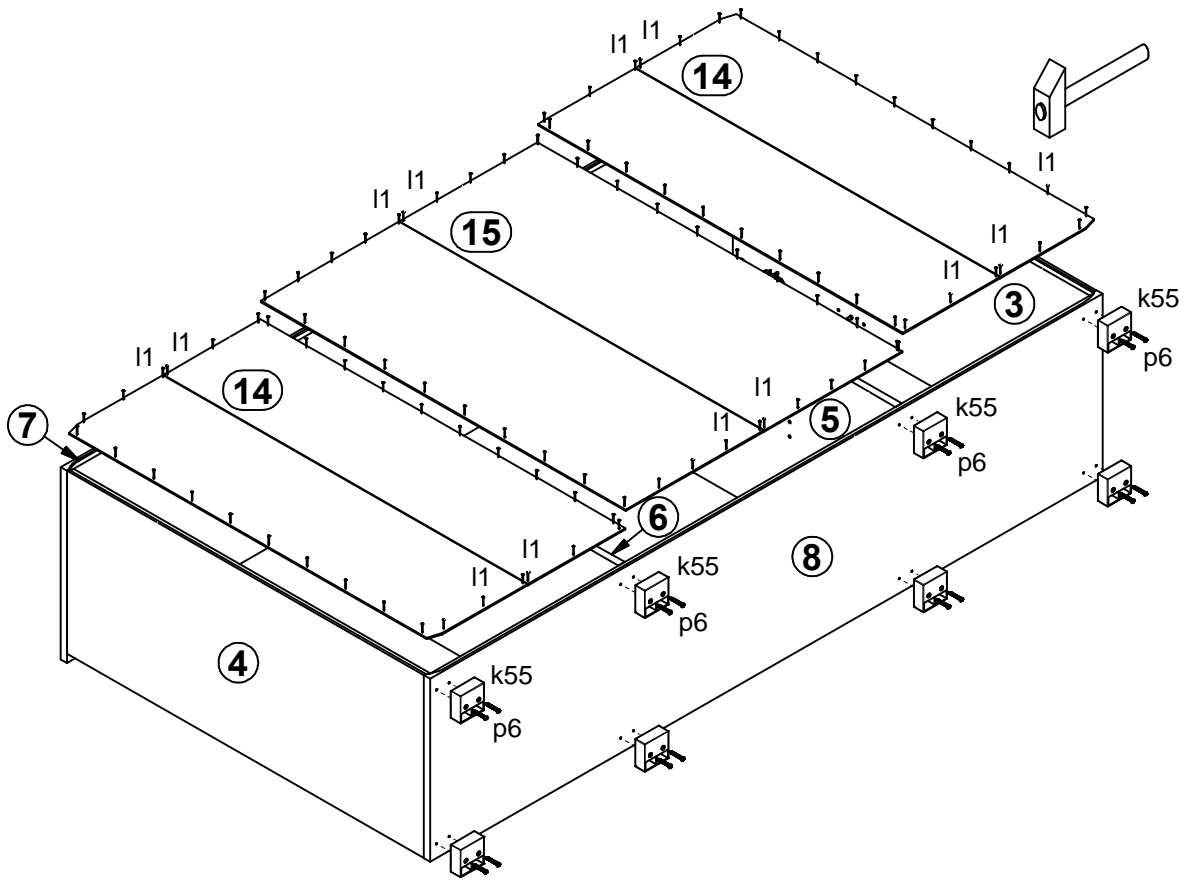

# 4

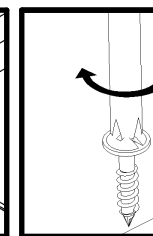
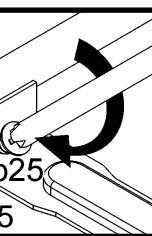
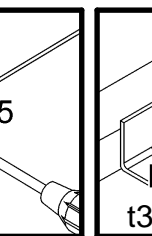
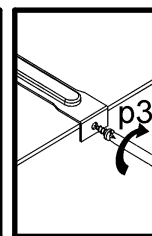
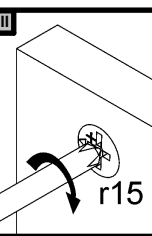
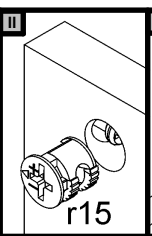
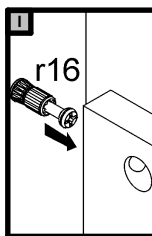
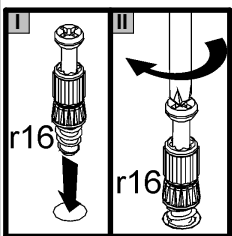
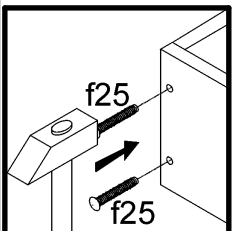
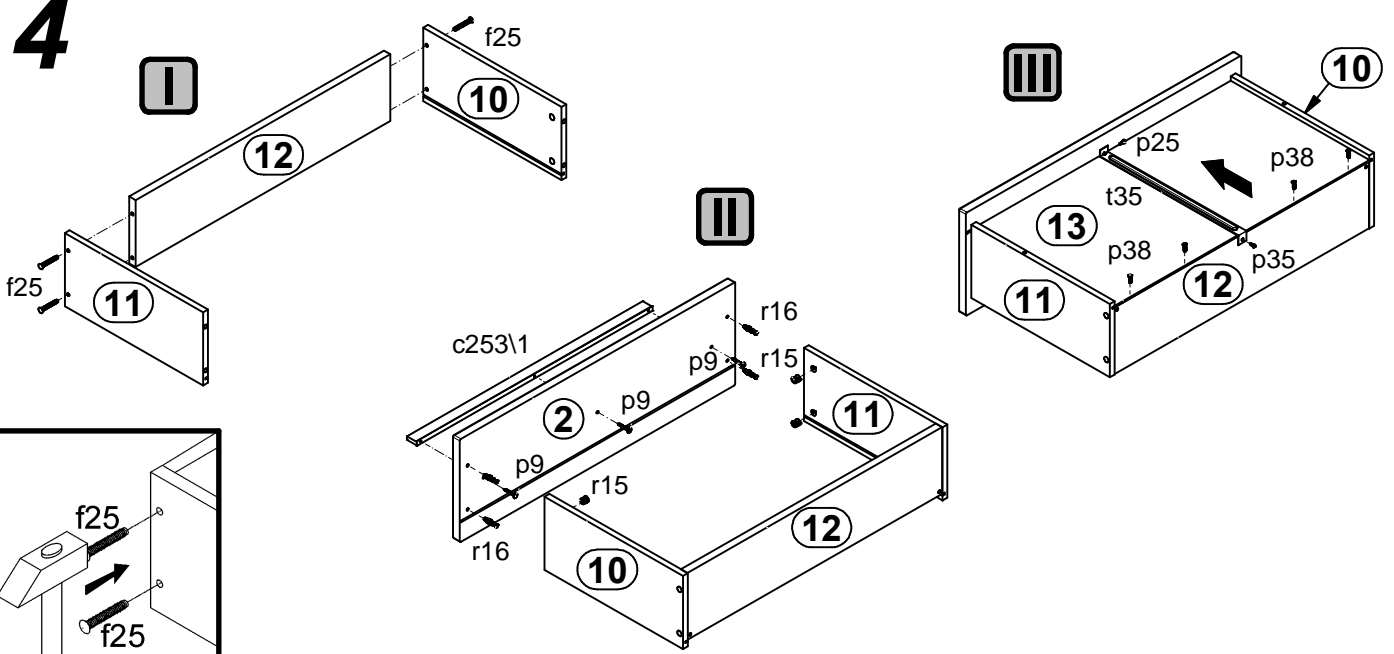

# 5

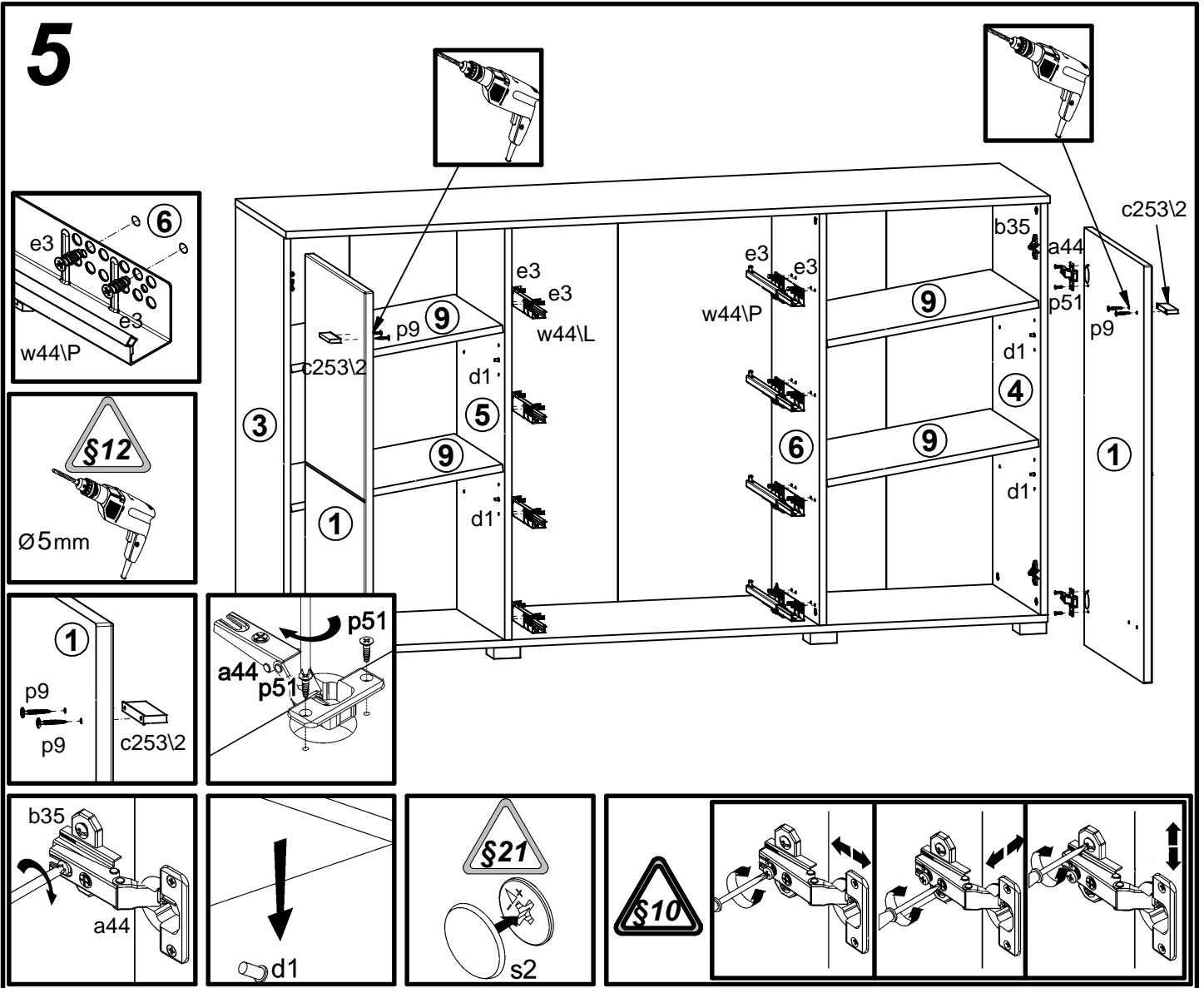

# 6

