

AFFI

S75-LAW/140

A	B	C	D
1	S75-101	446	598
2	S75-201	1400	600
3	S75-301	1323	596
4	S75-401	1323	60

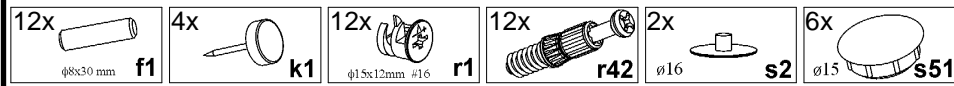
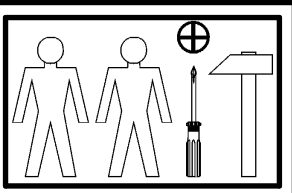
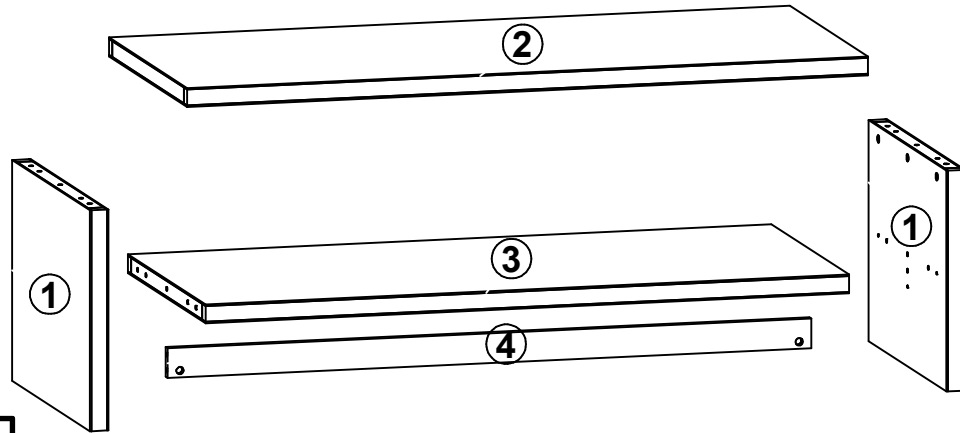

1 §2

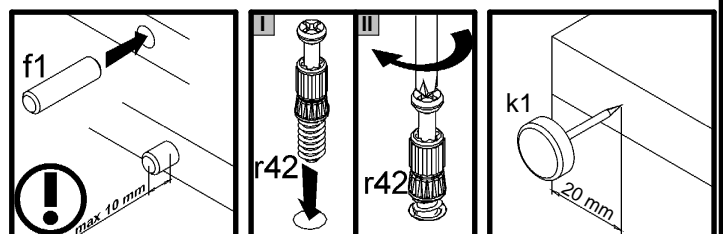
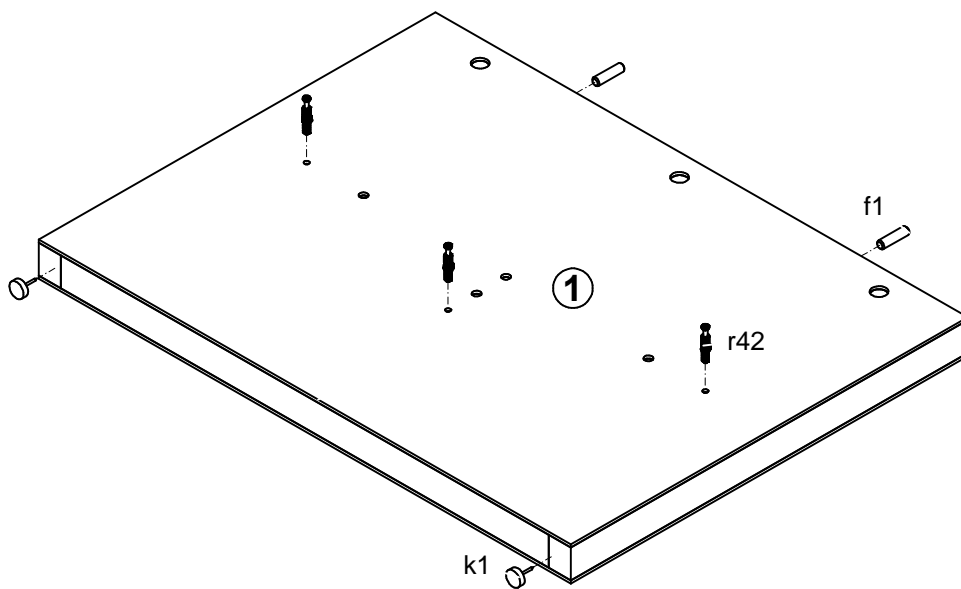

2

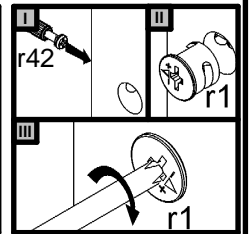
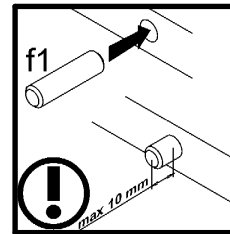
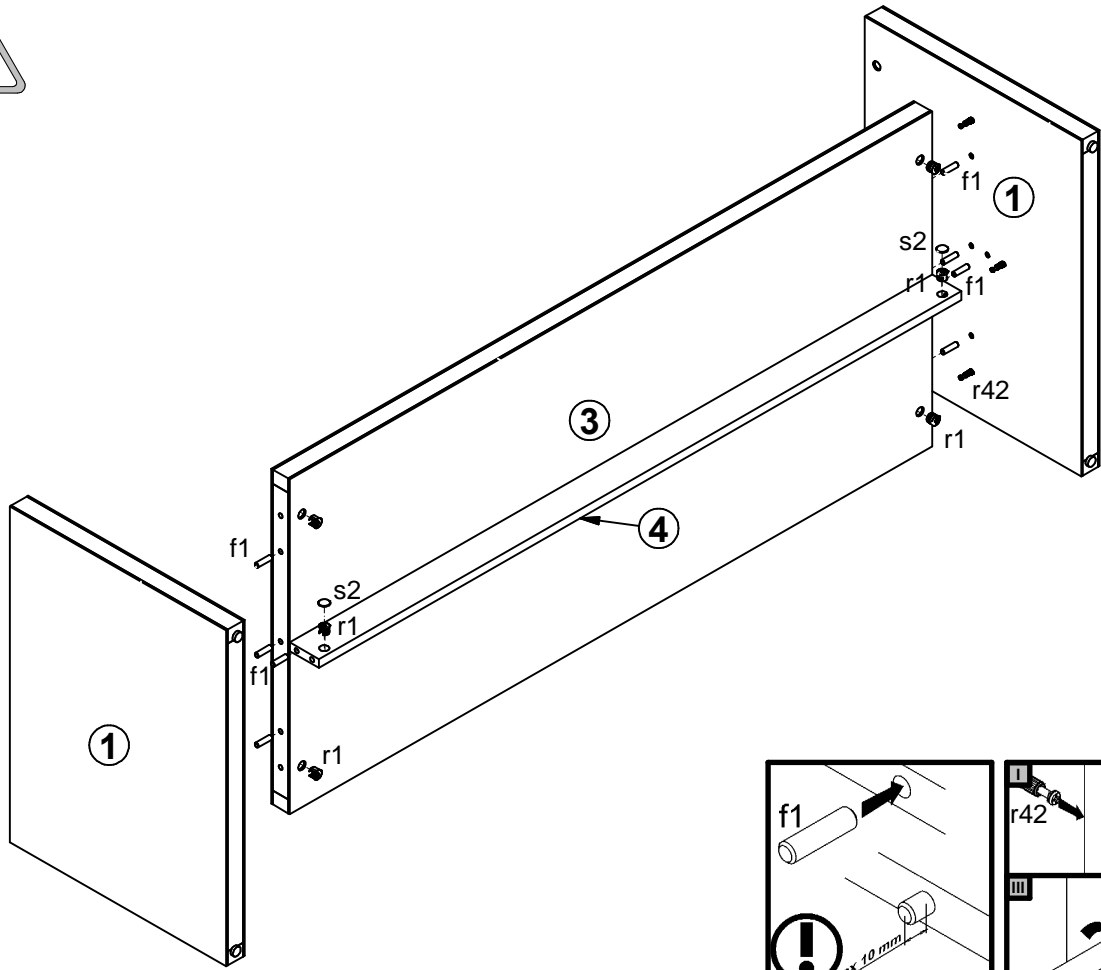

3

