

BIGGER

S78-BIU/140

A	B	C	D	
1	S78-006	498	446	4/4
2	S78-007	446	150	4/4
3	S78-111	717	674	2/4
4	S78-112	717	648	2/4
5	S78-113	717	674	2/4
6	S78-205	1400	700	3/4
7	S78-315	886	365	1/4
8	S78-316	417	656	1/4
9	S78-317	417	654	1/4
10	S78-404	911	420	1/4
11	S78-405	417	60	1/4
12	S78-408	717	417	2/4
13	S78-573	717	33	1/4
14	S78-905	379	498	4/4
15	ZS1-503	500	120	2/4
16	ZS1-504	500	120	2/4
17	ZS1-5530	368	120	2/4

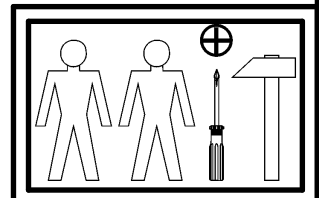
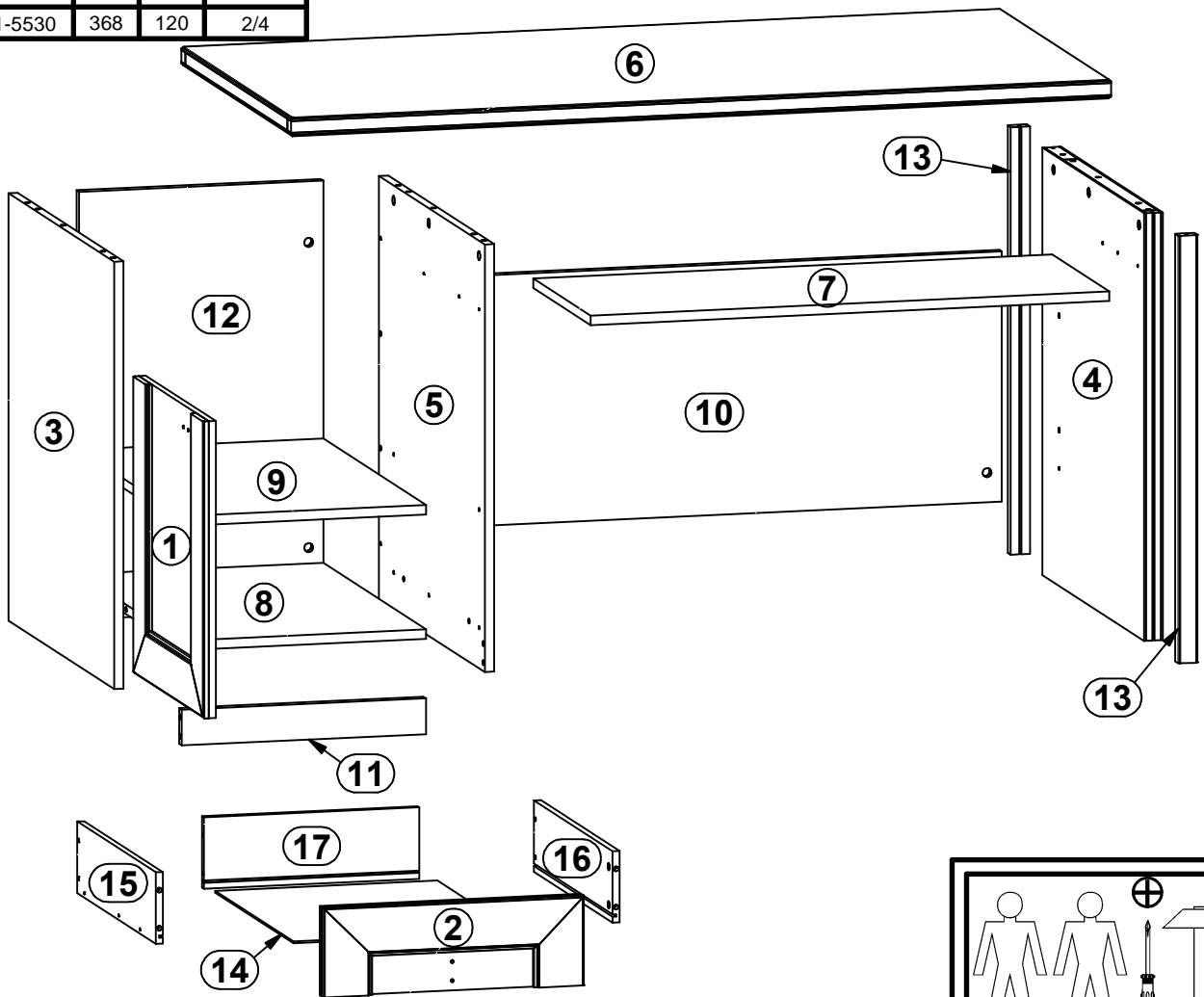
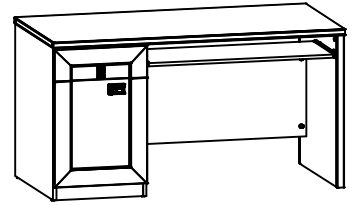

2x a44	2x b33	1x c239\1	1x c239\2	4x d1 φ5x17 mm	6x e19 φ5x9 mm	4x e2 φ6,3x13 mm	12x e3 φ6x13 mm	22x f1 φ8x30 mm
8x f11 46x18¼ mm	4x f25 φ6,5x40 mm	3x j83 M4x16 mm	6x k1	4x p27 φ3,5x13 mm	4x p51 φ3,5x15 mm	23x r1 φ1,5x12mm #16	4x r15 φ12x10,5mm #12	27x r16
6x s2 ø16	3x s51 ø15	1x w26\CL 500 mm	1x w26\CR 500 mm	1x w26\DL 500 mm	1x w26\DR 500 mm	1x w45\CL 350 mm	1x w45\CR 350 mm	1x w45\DL 350 mm
1x w45\DR 350 mm	1x y1 GLUE							

1

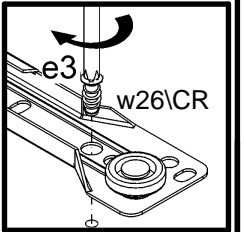
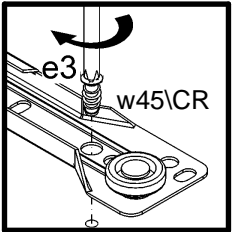
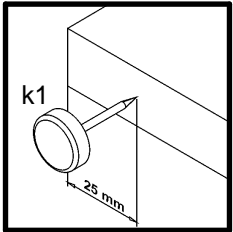
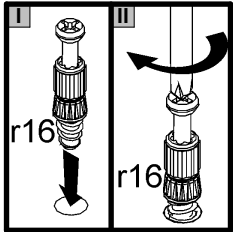
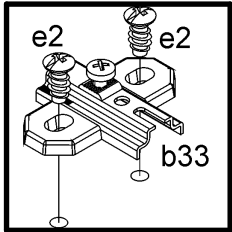
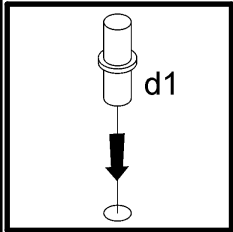
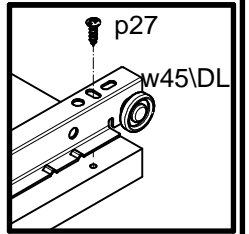
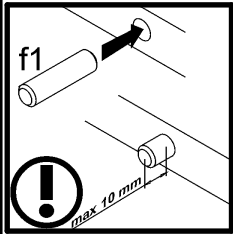
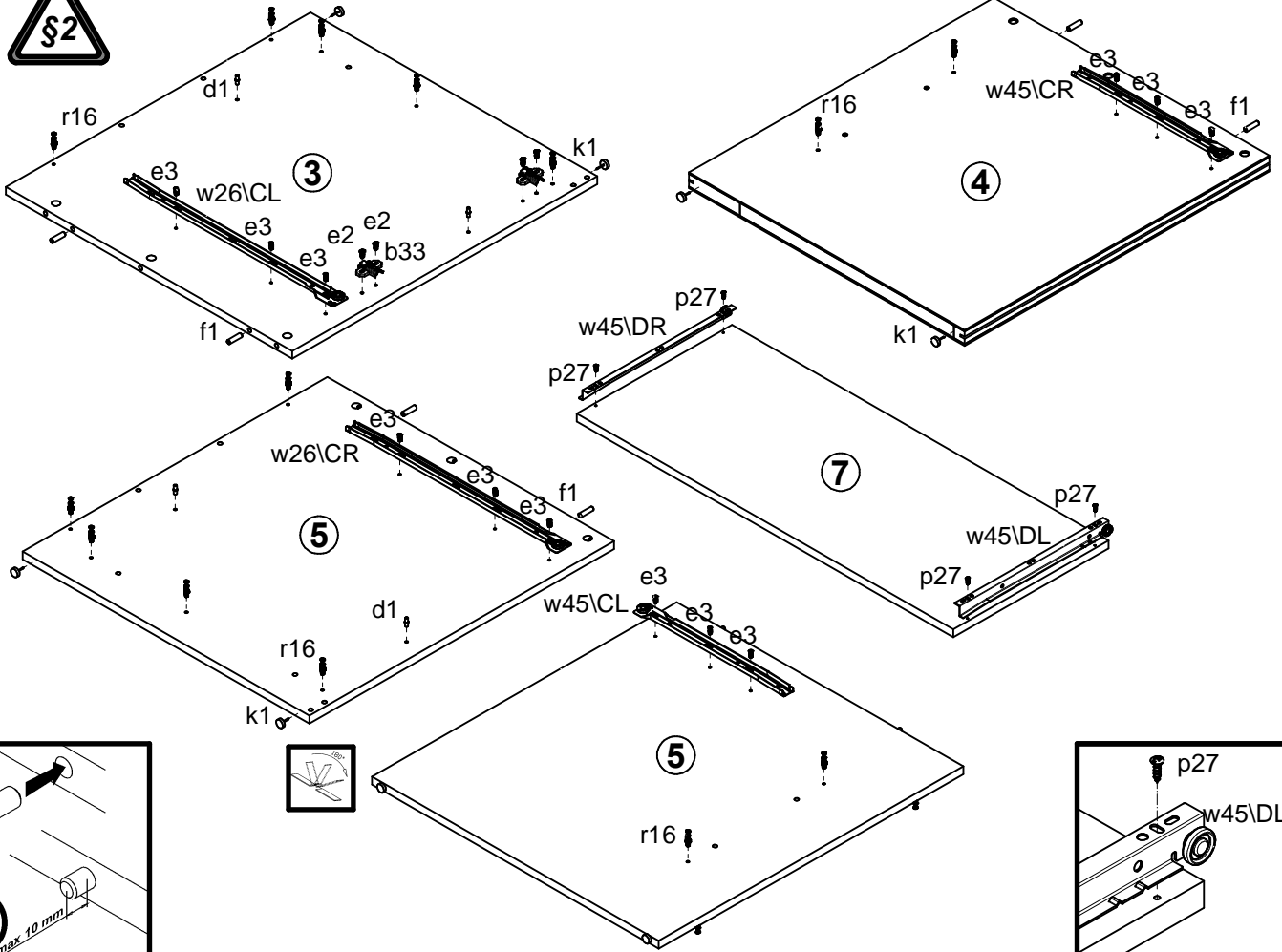

2

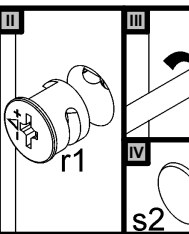
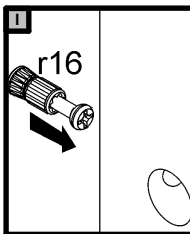
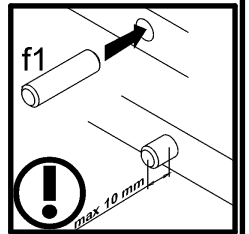
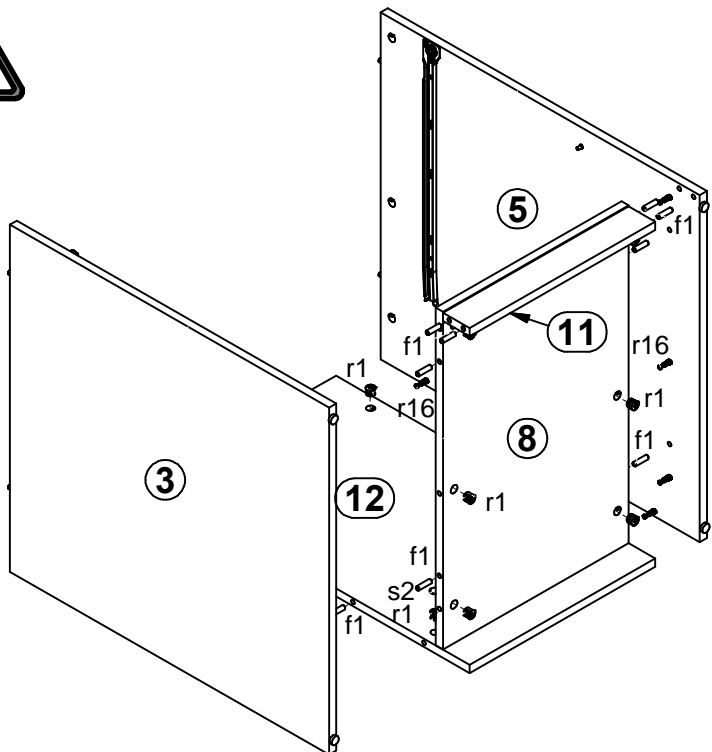

3

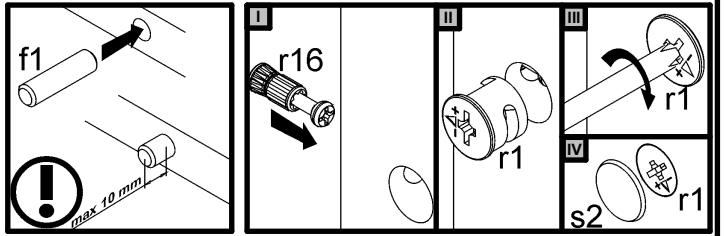
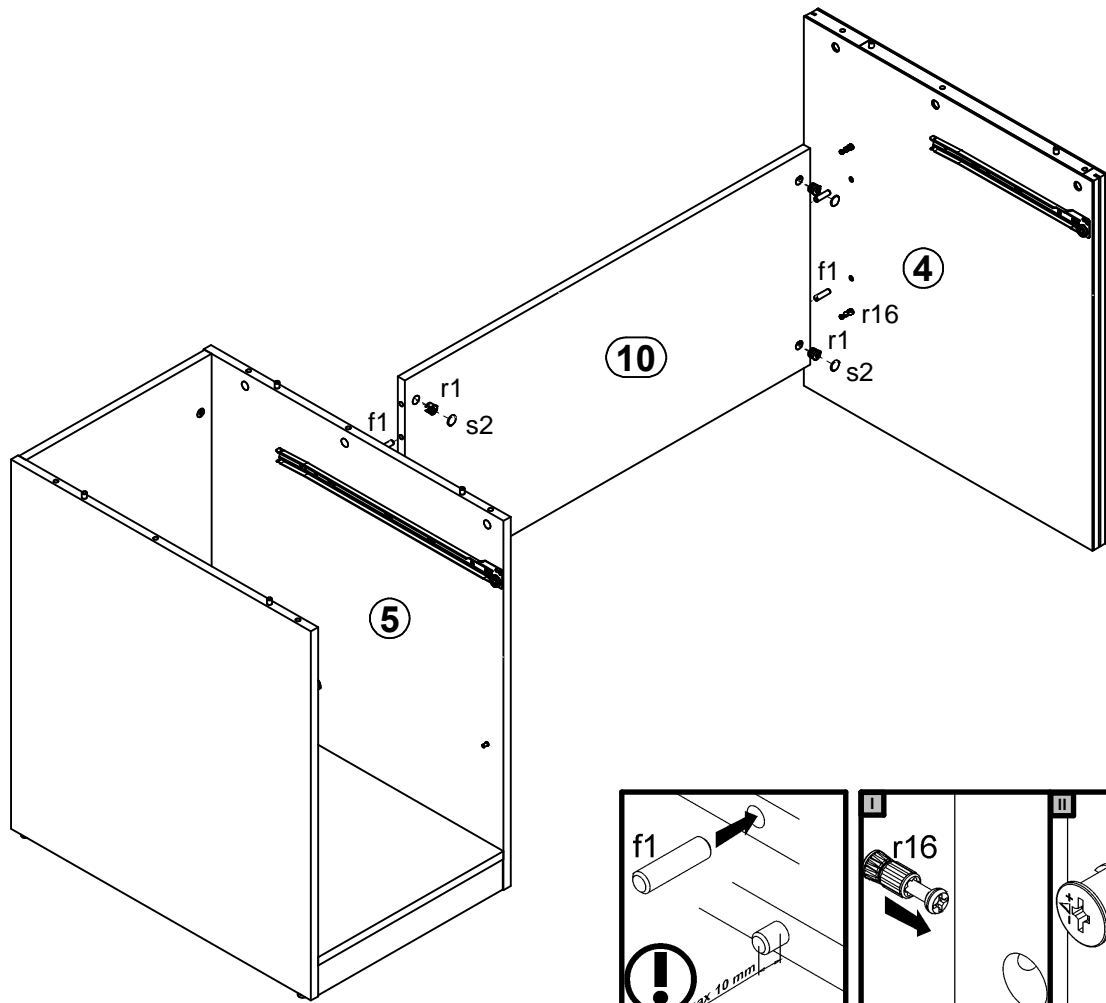

4

