

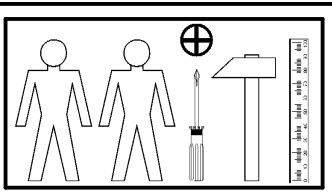

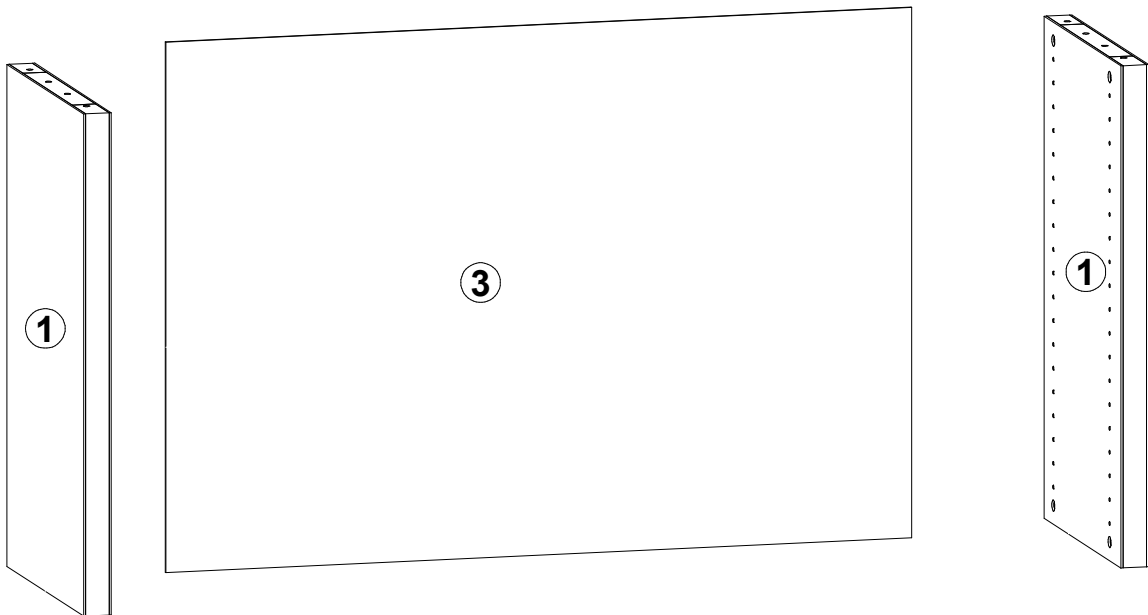

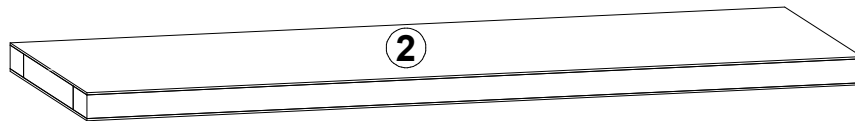

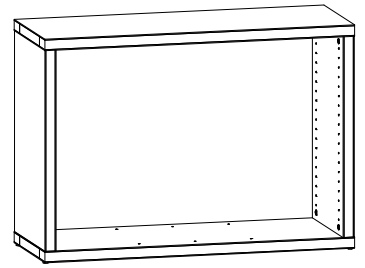

A	B	C		D
1	S68-101	676	392	1/3
2	S68-201	1062	393	2/3
3	S68-901	714	1022	3/3



- |  |  |   |   |   |  |   |   |
|--|--|---|---|---|--|---|---|
| 8x<br><br>φ8x30 mm<br><b>f1</b> | 4x<br><br><b>k1</b> | 35x<br><br><b>l1</b> | 8x<br><br>φ1.5x12mm #16<br><b>r1</b> | 8x<br><br><b>r42</b> | 8x<br><br>ø15<br><b>s51</b> | 1x<br><br><b>n26\1</b> | 1x<br><br>φ3.5x16 mm<br><b>p38</b> |
|--|--|---|---|---|--|---|---|

# 1

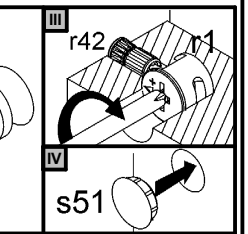
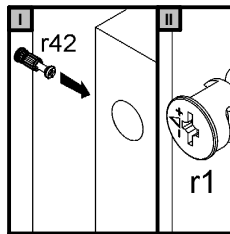
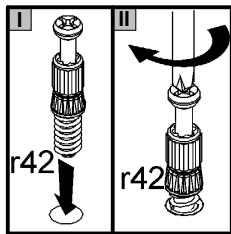
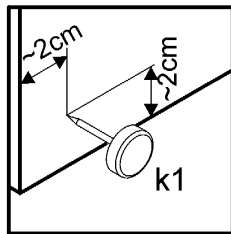
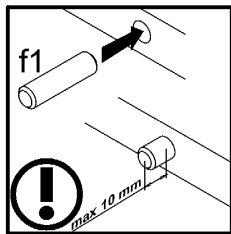
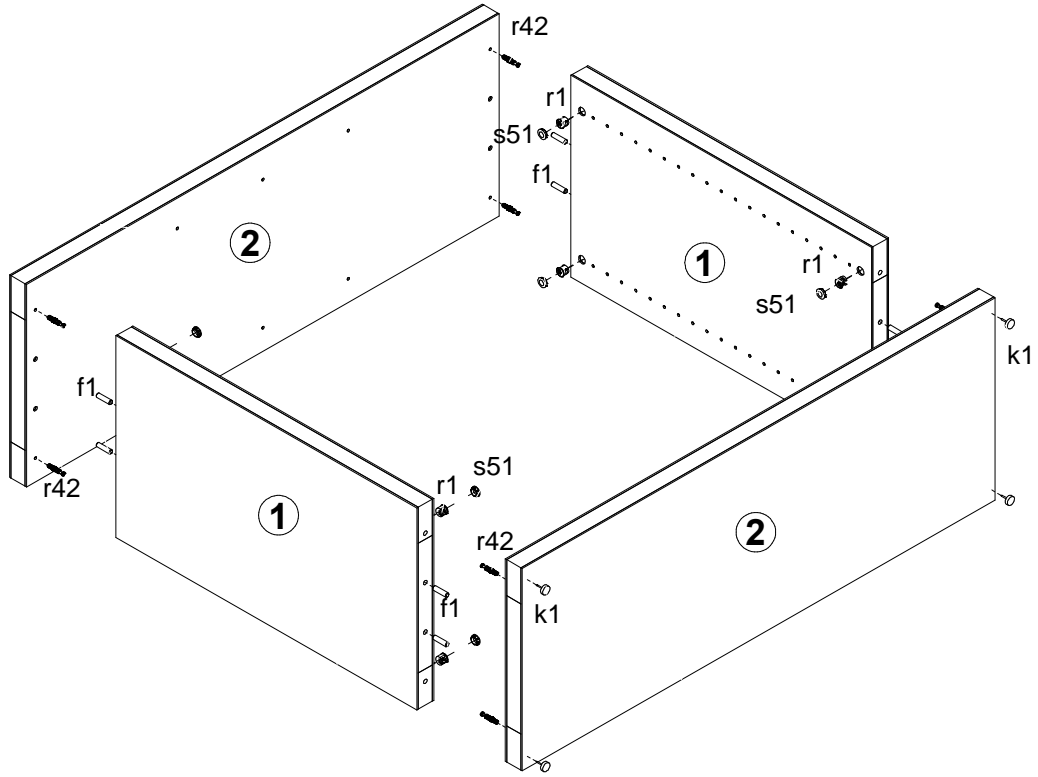

# 2

