

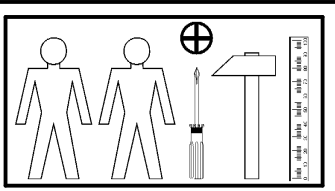

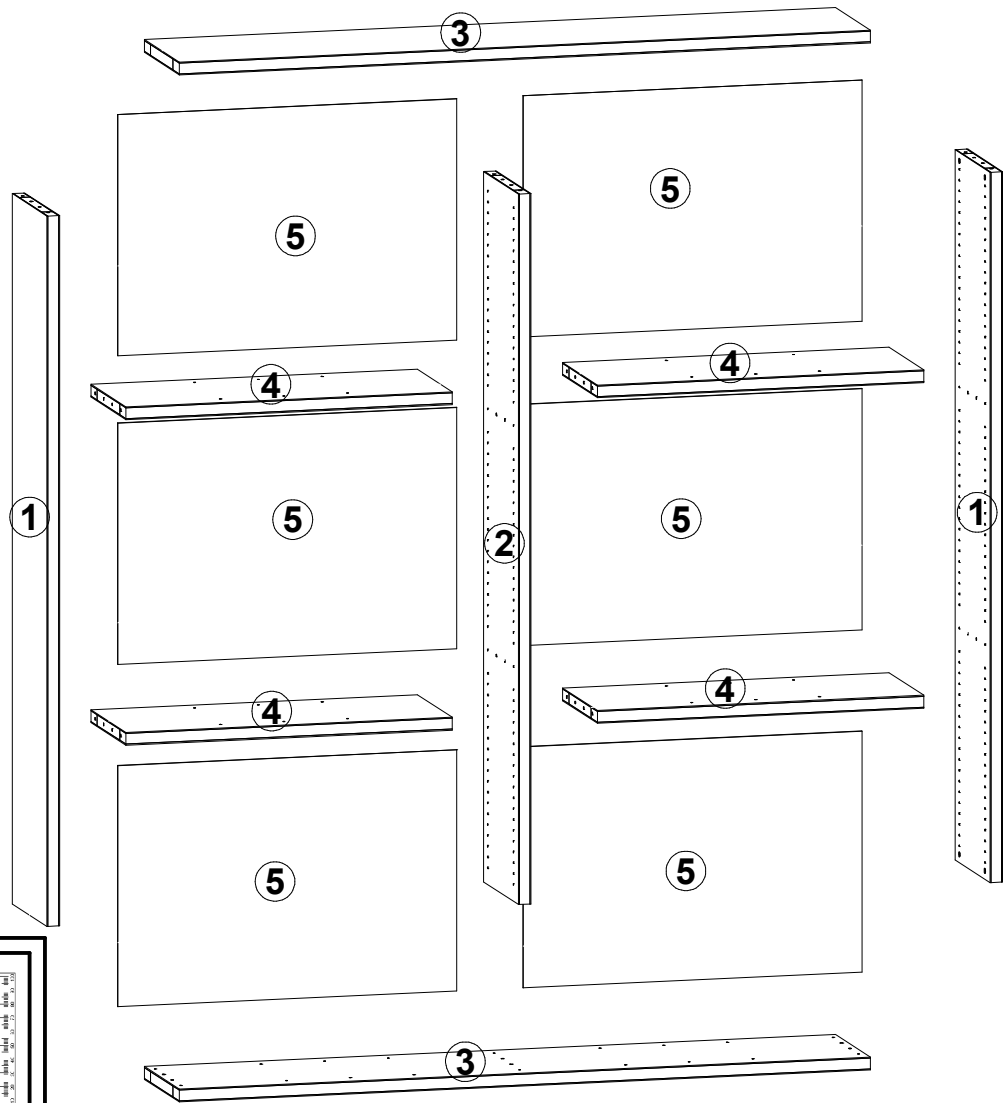

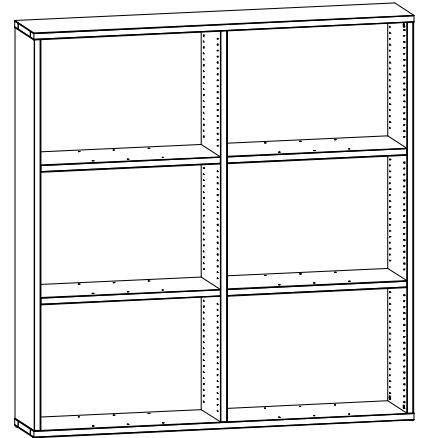



A	B	C	D
1	S68-102	2104	392 1/6
2	S68-104	2104	392 1/6
3	S68-202	2084	393 2/6
4	S68-301	984	392 3/6
5	S68-901	714	1022 4,5,6/6



- 
 28x
 φ8x30 mm **f1**
- 
 6x
k1
- 
 210x
l1
- 
 28x
 φ1.5x12mm #16 **r1**
- 
 28x
r42
- 
 28x
 ø15 **s51**
- 
 1x
n26/1
- 
 1x
 φ3.5x16 mm **p38**

1

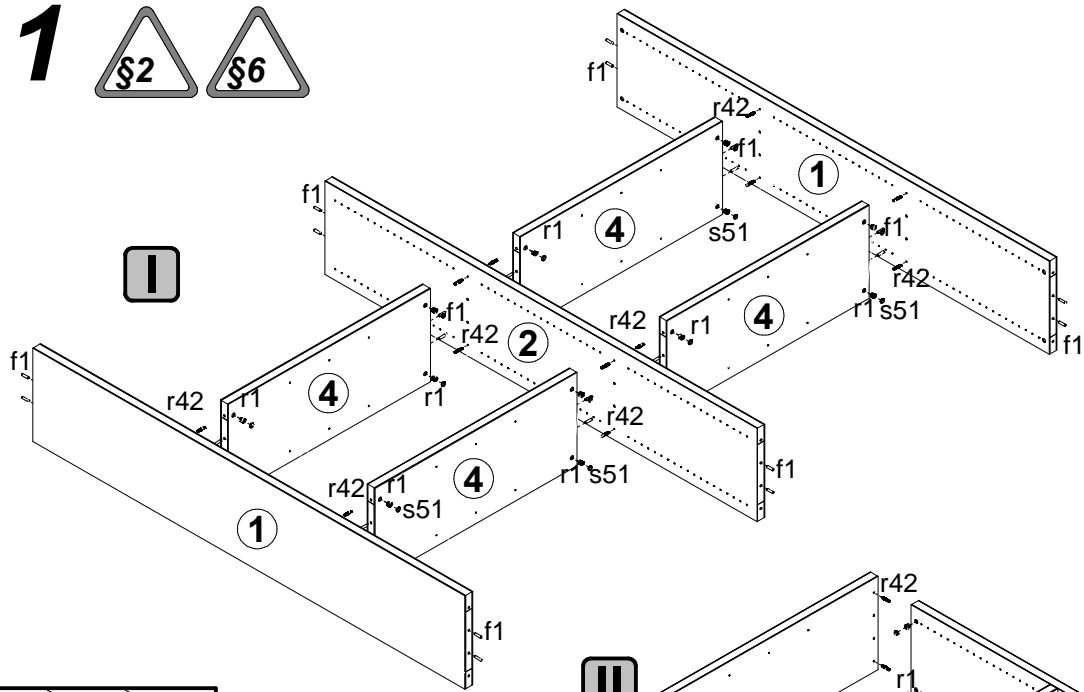

II

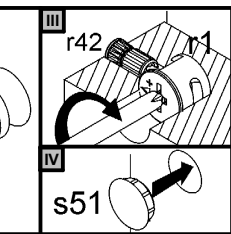
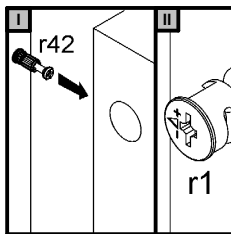
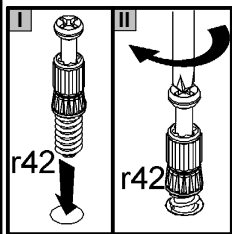
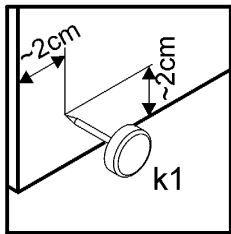
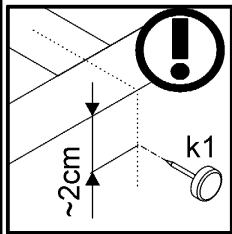
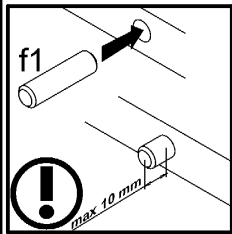
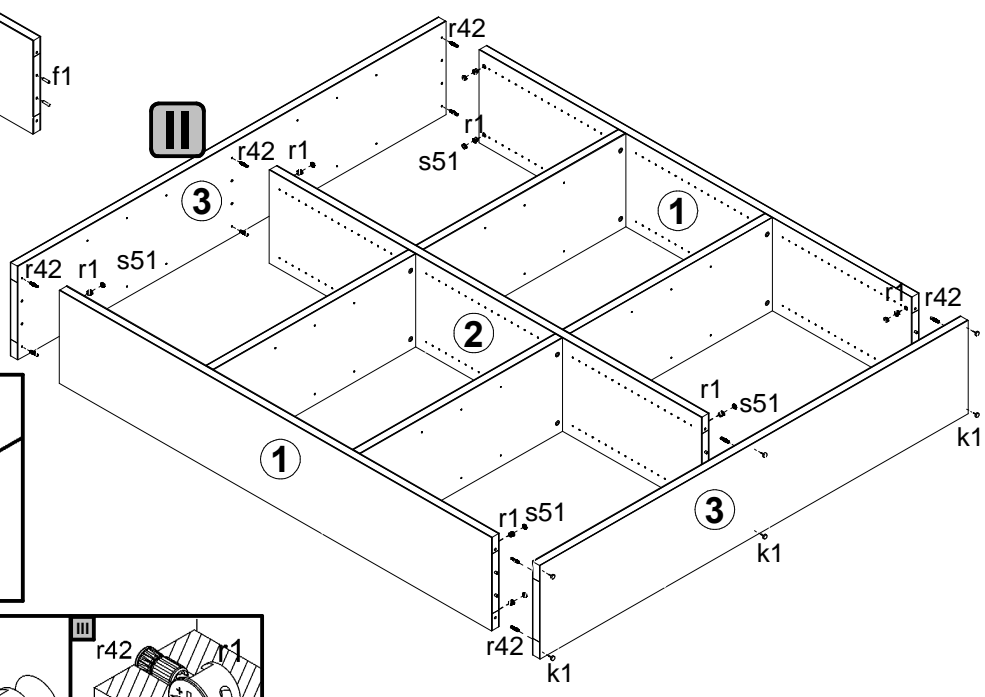

2

