

| A | B | C | | D |
|---|------------|------|-----|-----|
| 1 | S68-123 | 328 | 250 | 1/2 |
| 2 | S68-124 | 328 | 250 | 1/2 |
| 3 | S68-217-01 | 1062 | 251 | 1/2 |
| 4 | S68-218 | 1062 | 251 | 1/2 |
| 5 | S68-912 | 338 | 994 | 1/2 |

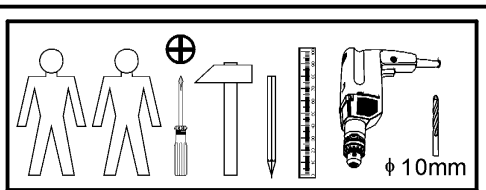

| | | | | | | | | |
|-----------------------|---------------------------|-----------|------------------|-----------|-------------|-------------|------------------------|-----------------------|
| 8x φ8x30 mm f1 | 2x φ10x50 mm f35 | 10x I2 | 2x m32 | 2x m34 | 1x n38\l | 1x n38\p | 4x φ3,5x13 mm p1 | 4x φ4x30 mm p21 |
| 2x φ5x60 mm p75 | 8x φ1,5x12mm #16 r1 | 8x r42 | 8x ø15 s51 | | | | | |

1

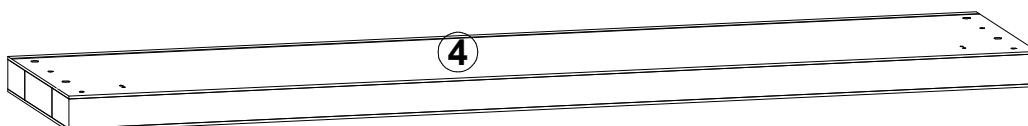
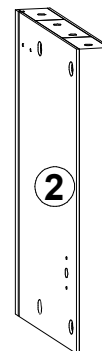
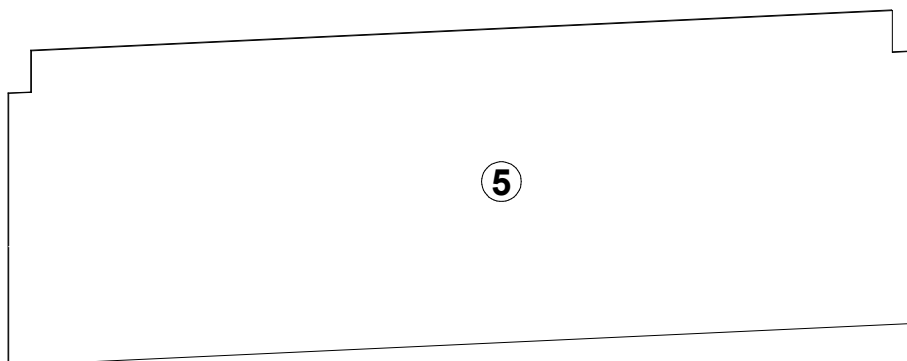
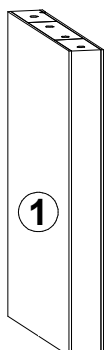
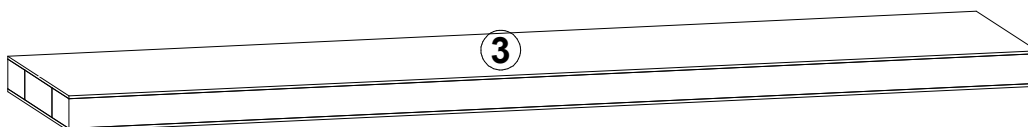
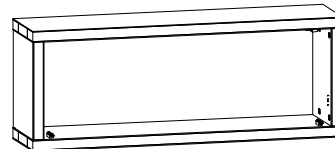
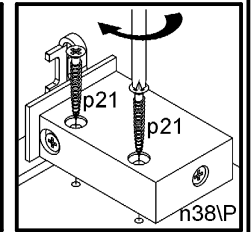
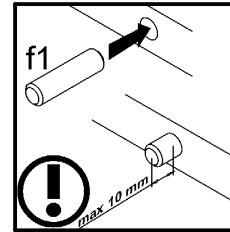
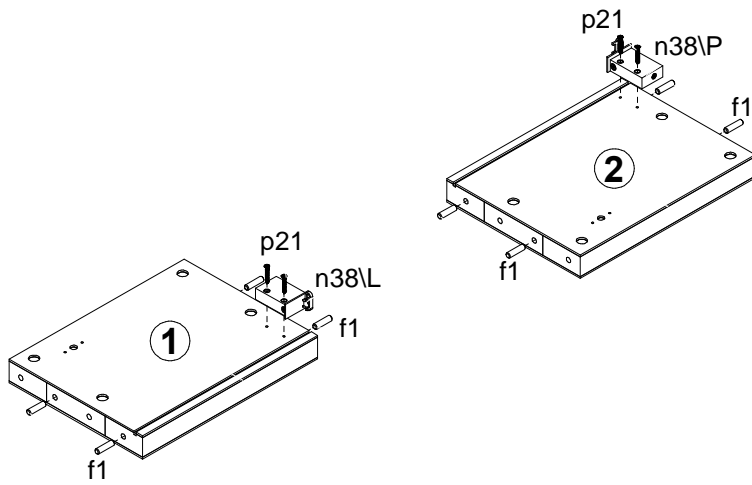

2

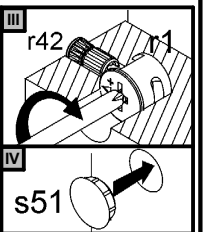
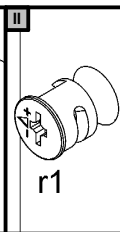
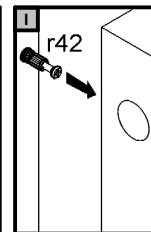
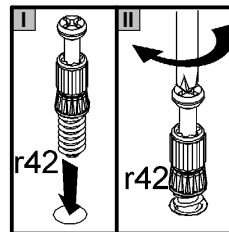
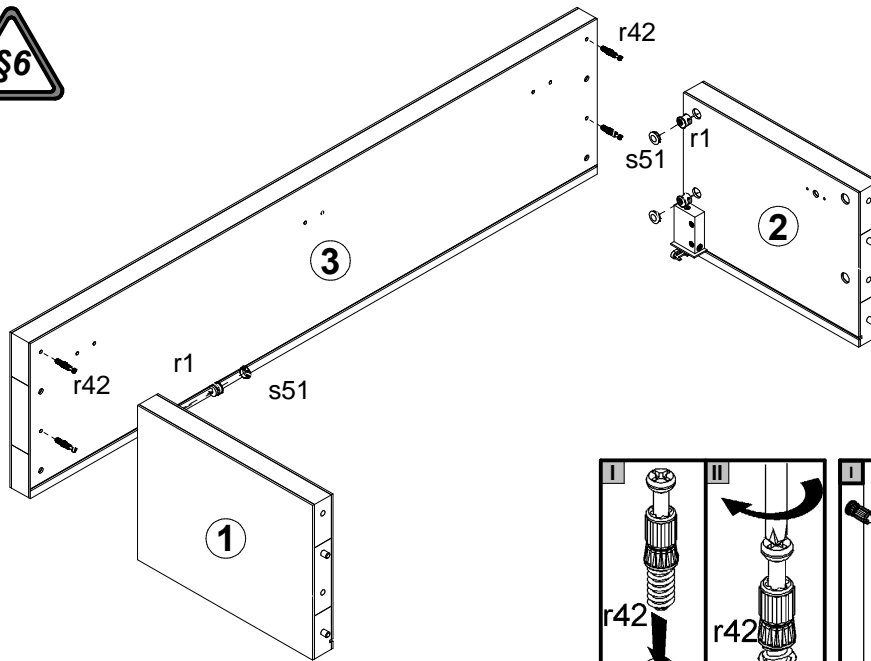

3

