

A	B	C	D	A	B	C	D		
1	S305-016	1236	496	4/5	12	S305-313	1089	540	2/5
2	S305-017	1236	496	4/5	13	S305-314	604	534	2/5
3	S305-018	644	496	4/5	14	S305-425	1708	60	2/5
4	S305-019	644	496	4/5	15	S305-426	496	88	2/5
5	S305-020	1908	496	5/5	16	S305-509	1741	80	3/5
6	S305-124	2054	540	1/5	17	S305-526	2054	120	3/5
7	S305-125	2054	540	1/5	18	S305-527	2054	120	3/5
8	S305-126	1979	540	1/5	19	S305-911	2011	1109	1/5
9	S305-207	1740	540	2/5	20	S305-912	2011	625	1/5
10	S305-311	1709	540	2/5	21	dr-1085	1085	30	2/5
11	S305-312	605	540	2/5					

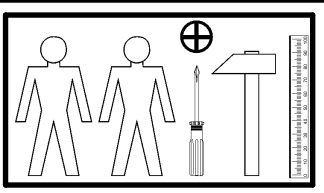

4x a44	8x a99	4x b19	8x b43	12x d1 Ø5x17 mm	3x e1 Ø7x50 mm	18x e2 Ø6.3x13 mm	36x f1 Ø8x30 mm	4x k1
2x k38/3	2x k38/8	135x l1	2x n158	2x p1 Ø3.5x13 mm	17x p8 Ø4x25 mm	8x p38 Ø3.5x16 mm	24x p51 Ø3.5x15 mm	50x r1 Ø15x12 mm #16
46x r42	2x r51	24x s2 Ø16	5x s51 Ø15	1x z1				

1 

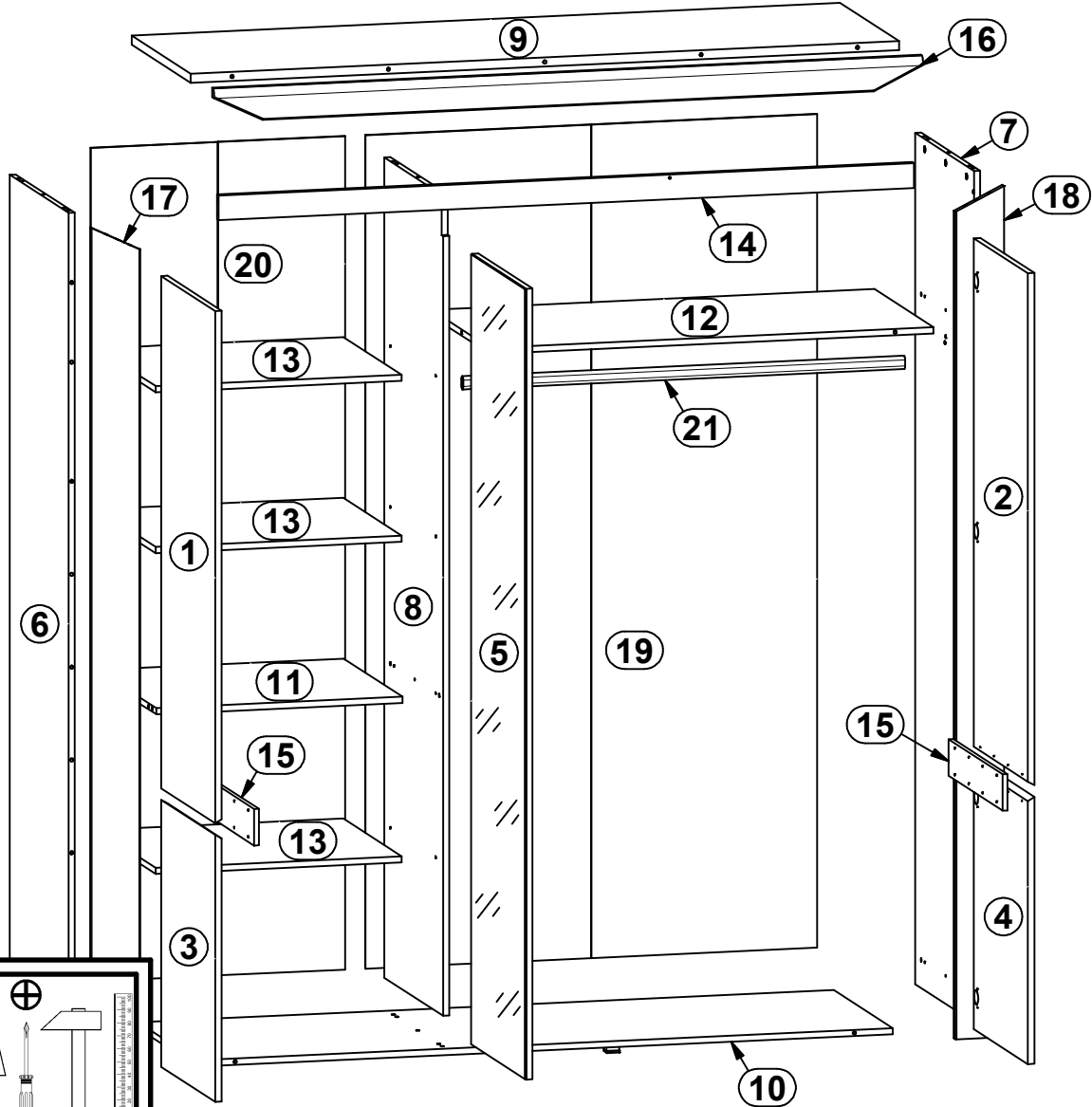
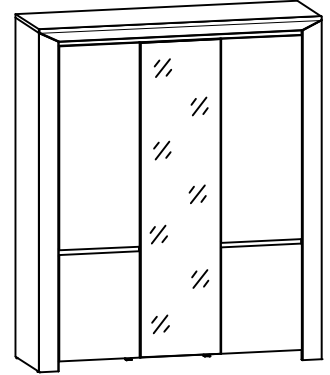
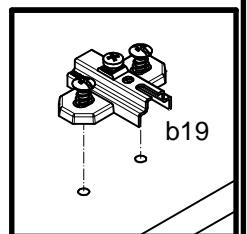
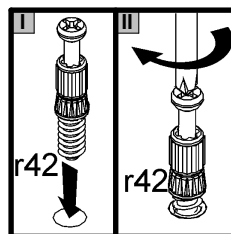
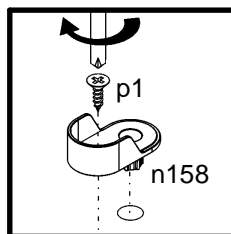
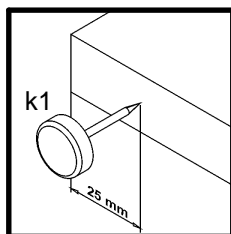
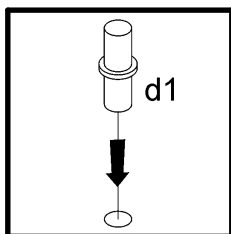
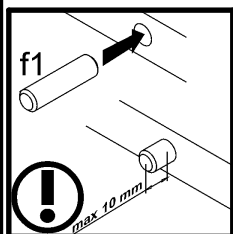
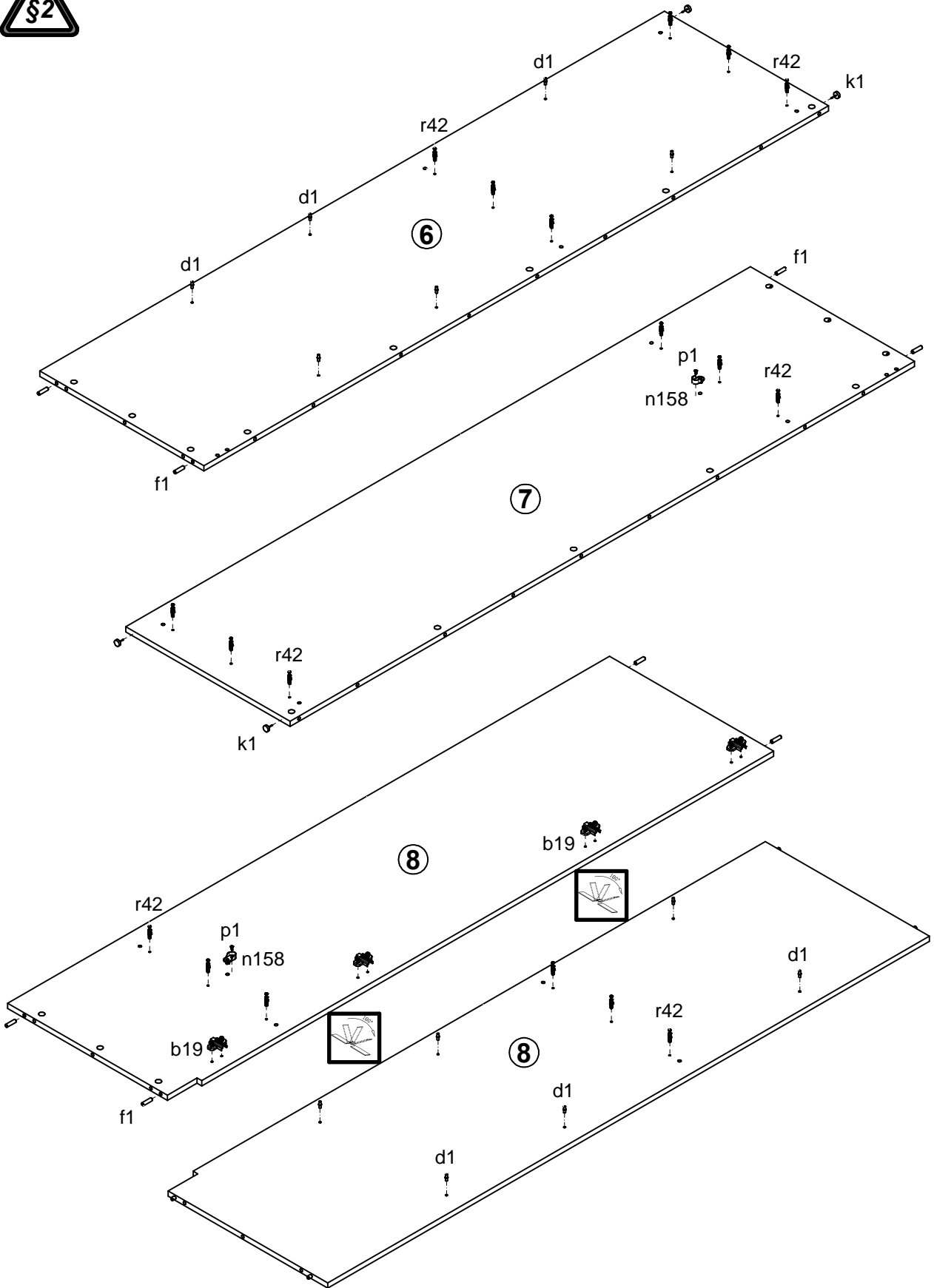

2

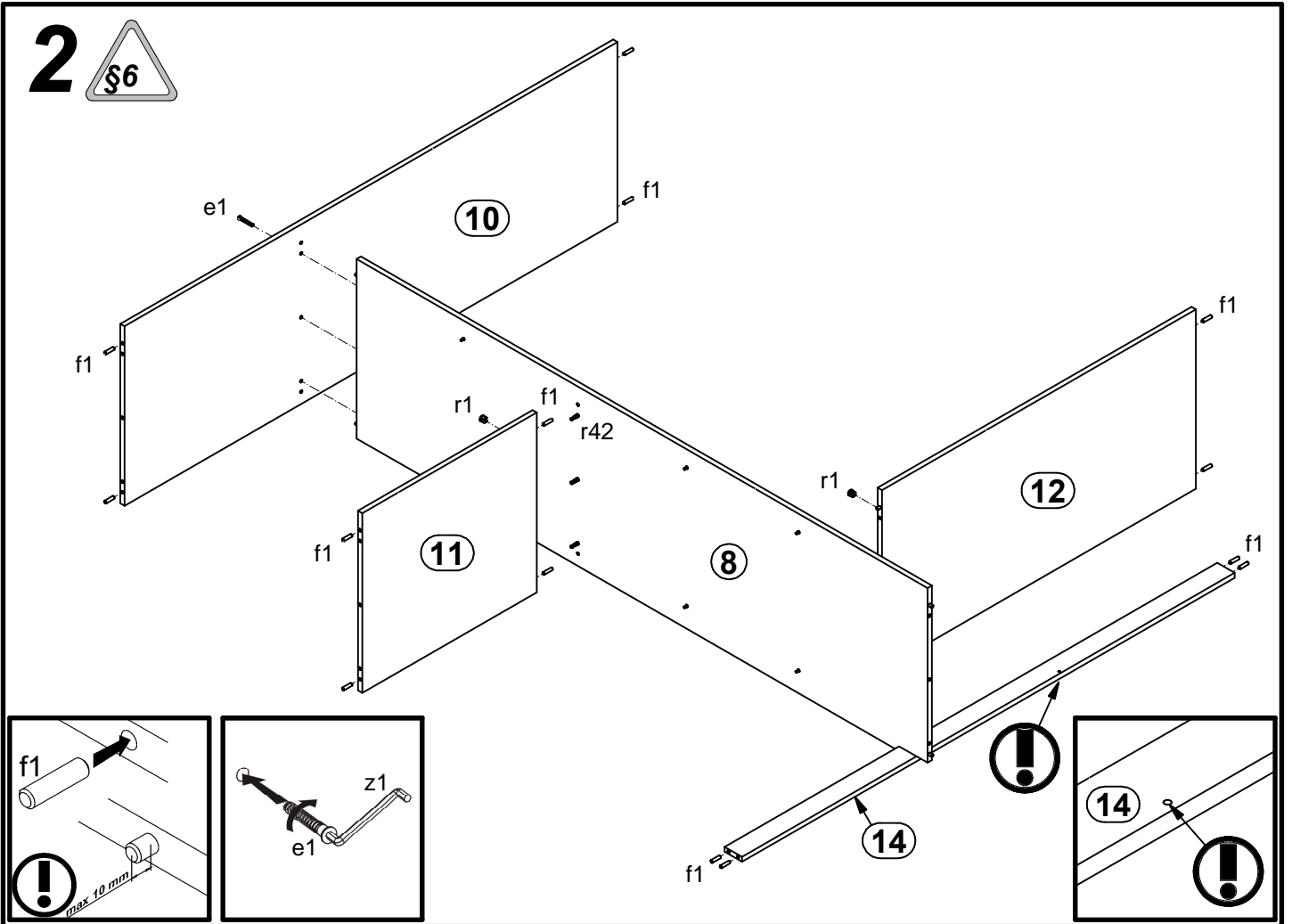

3

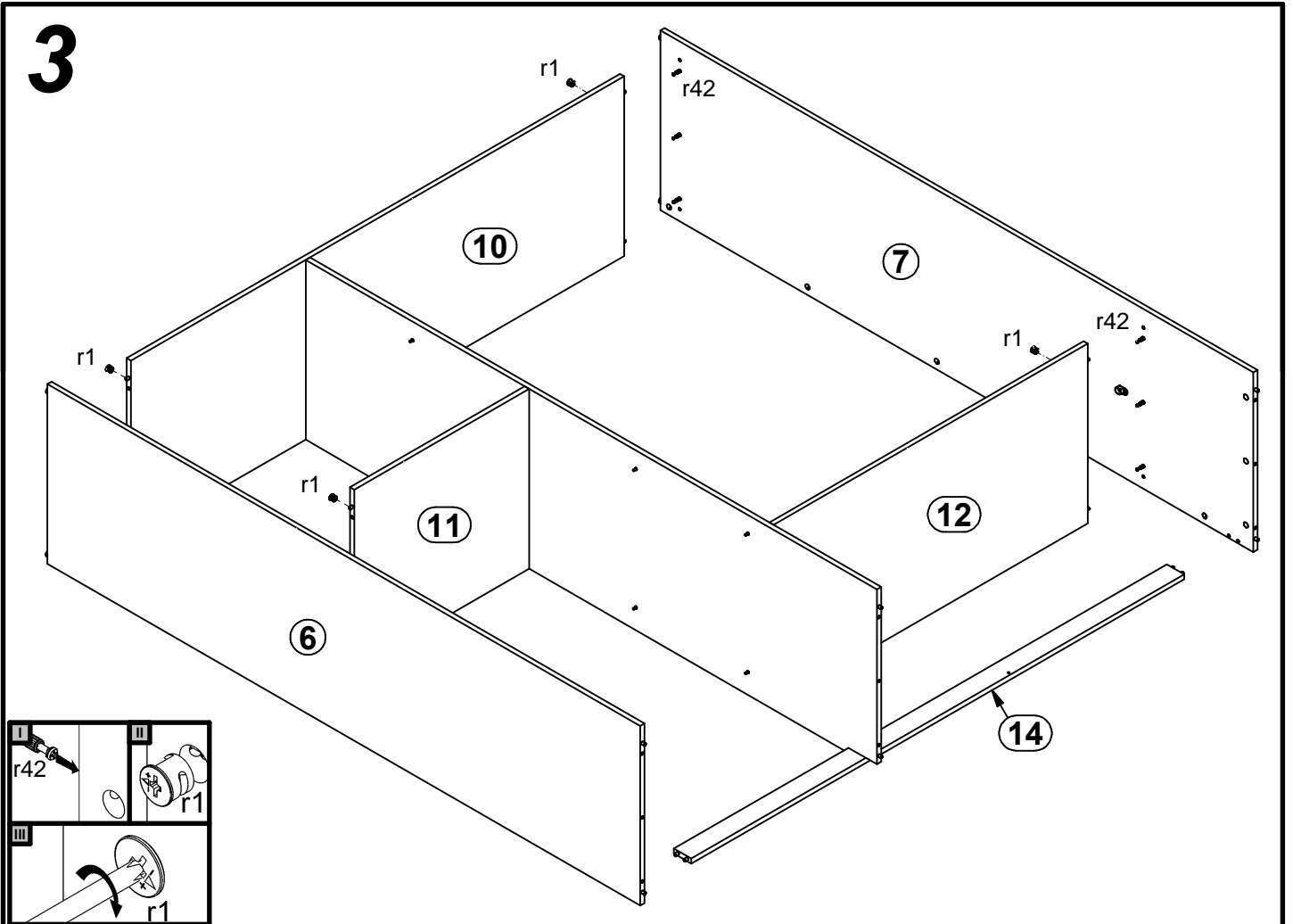

4

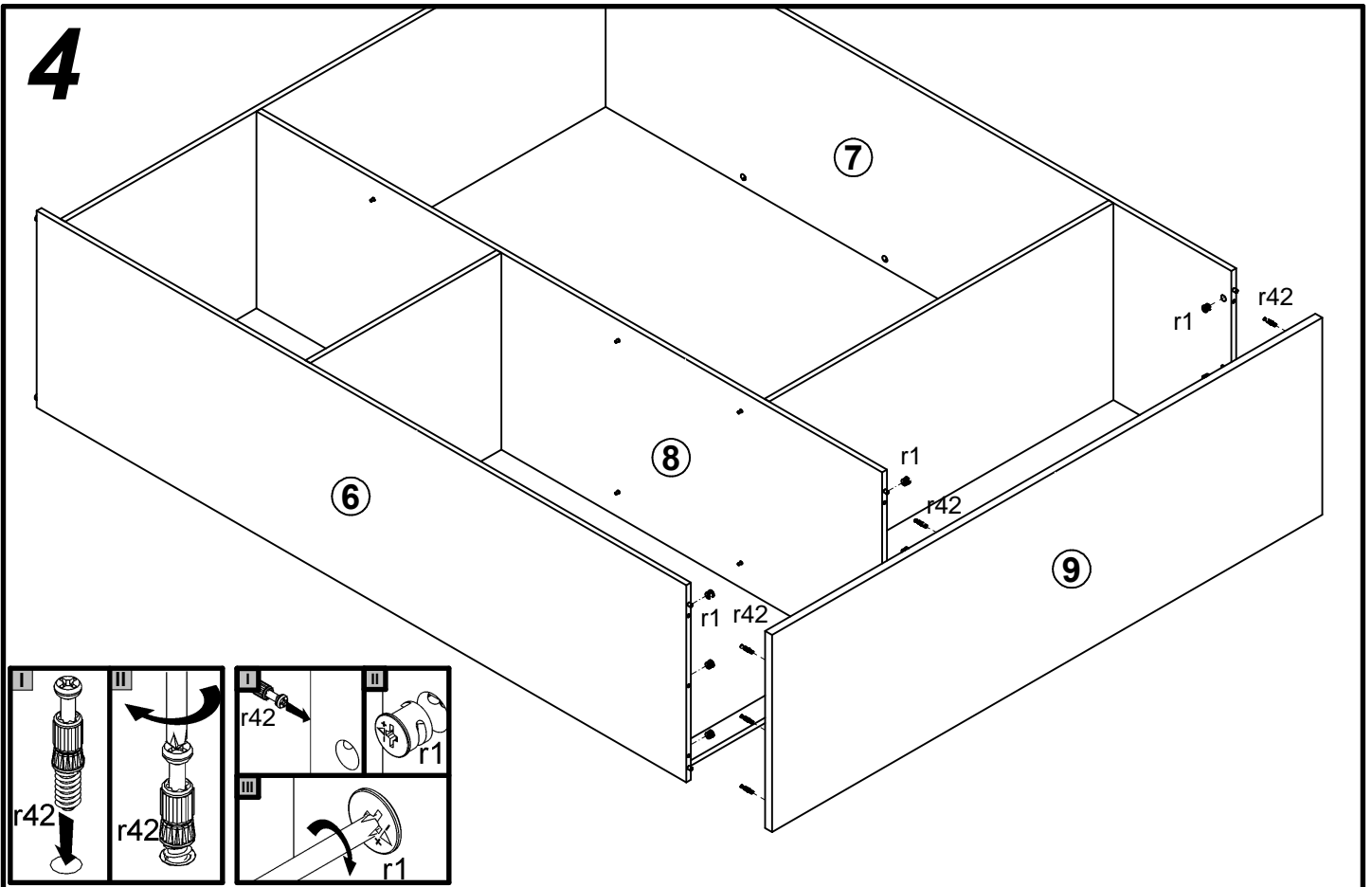

5

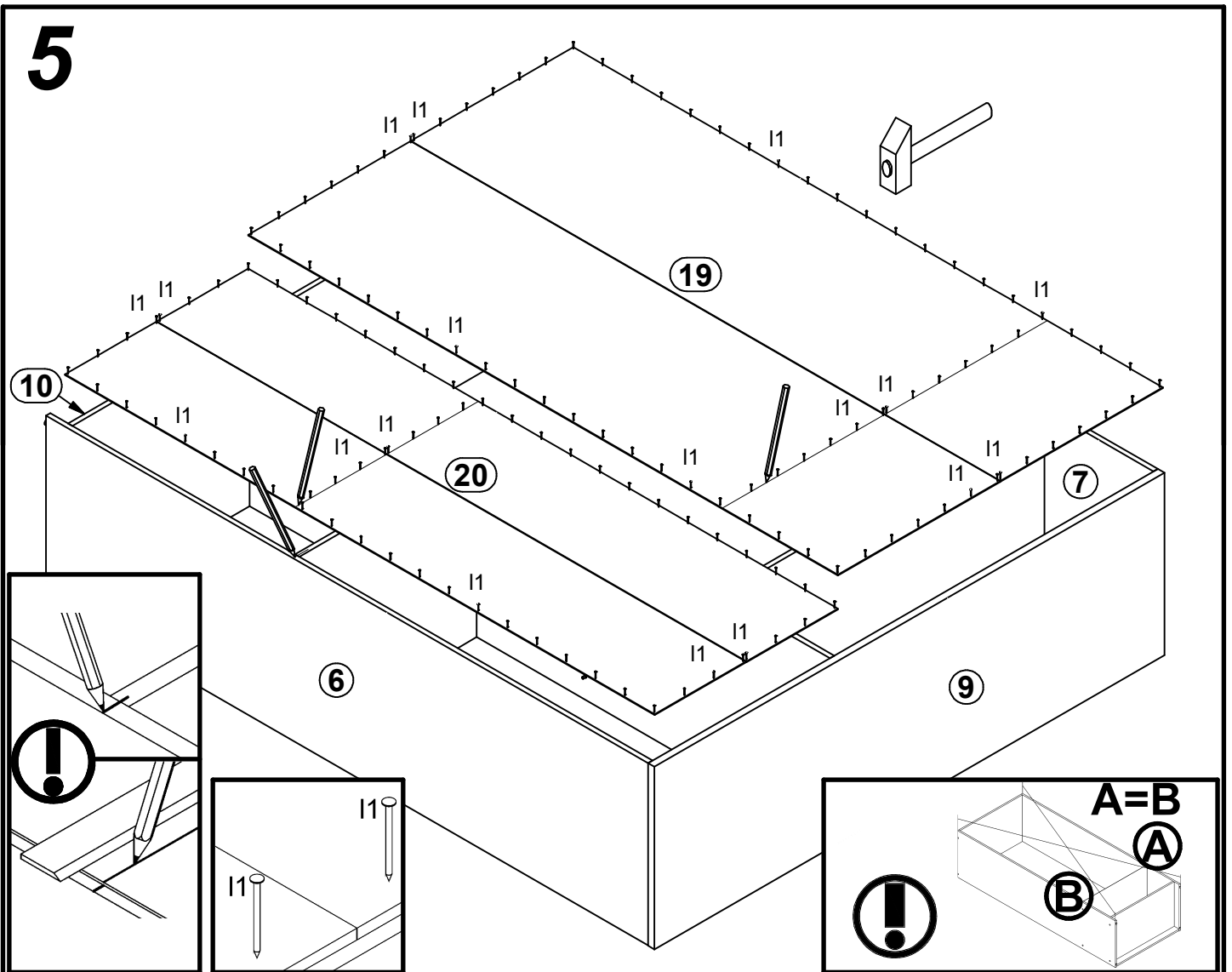

6

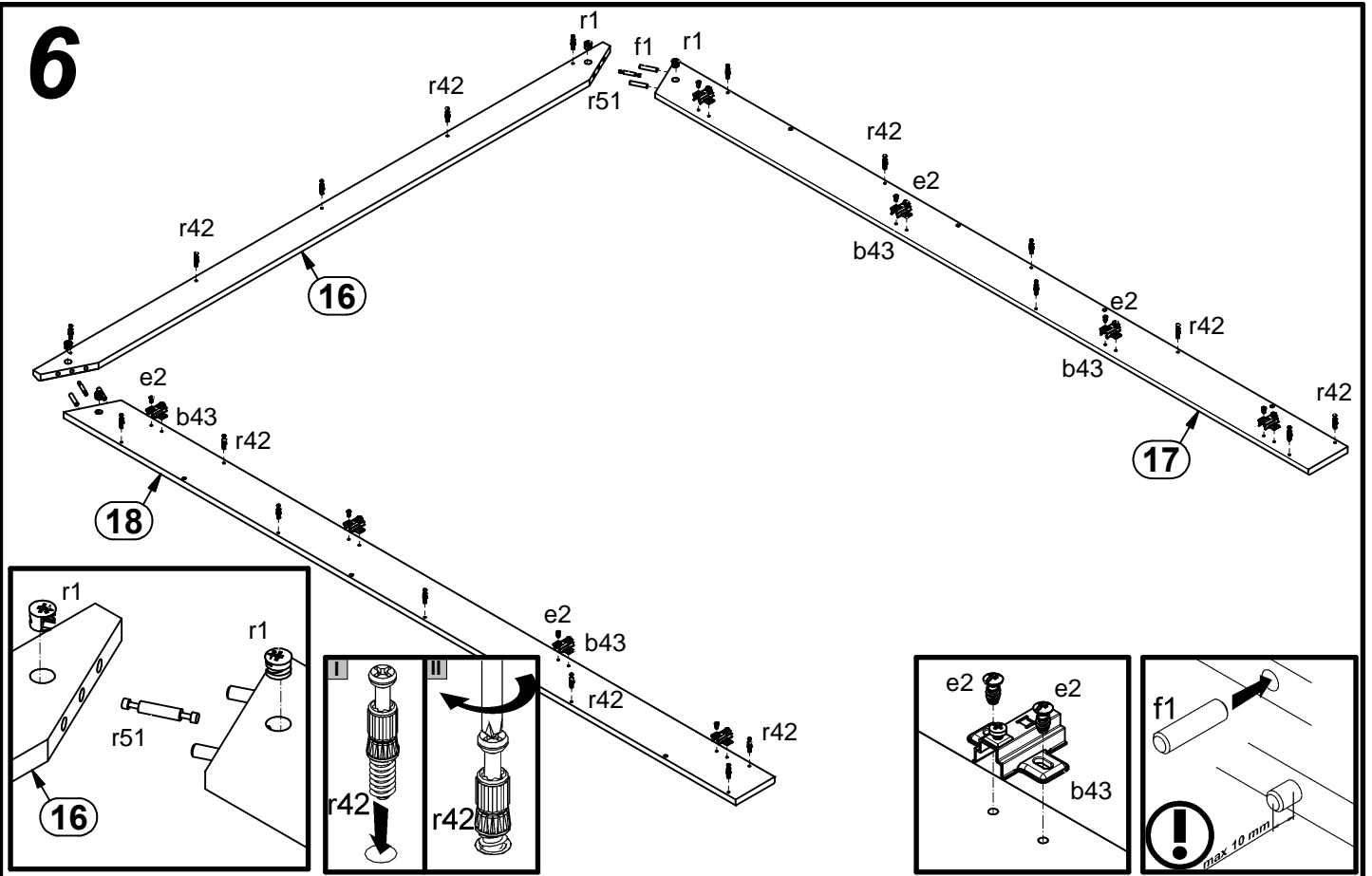

7

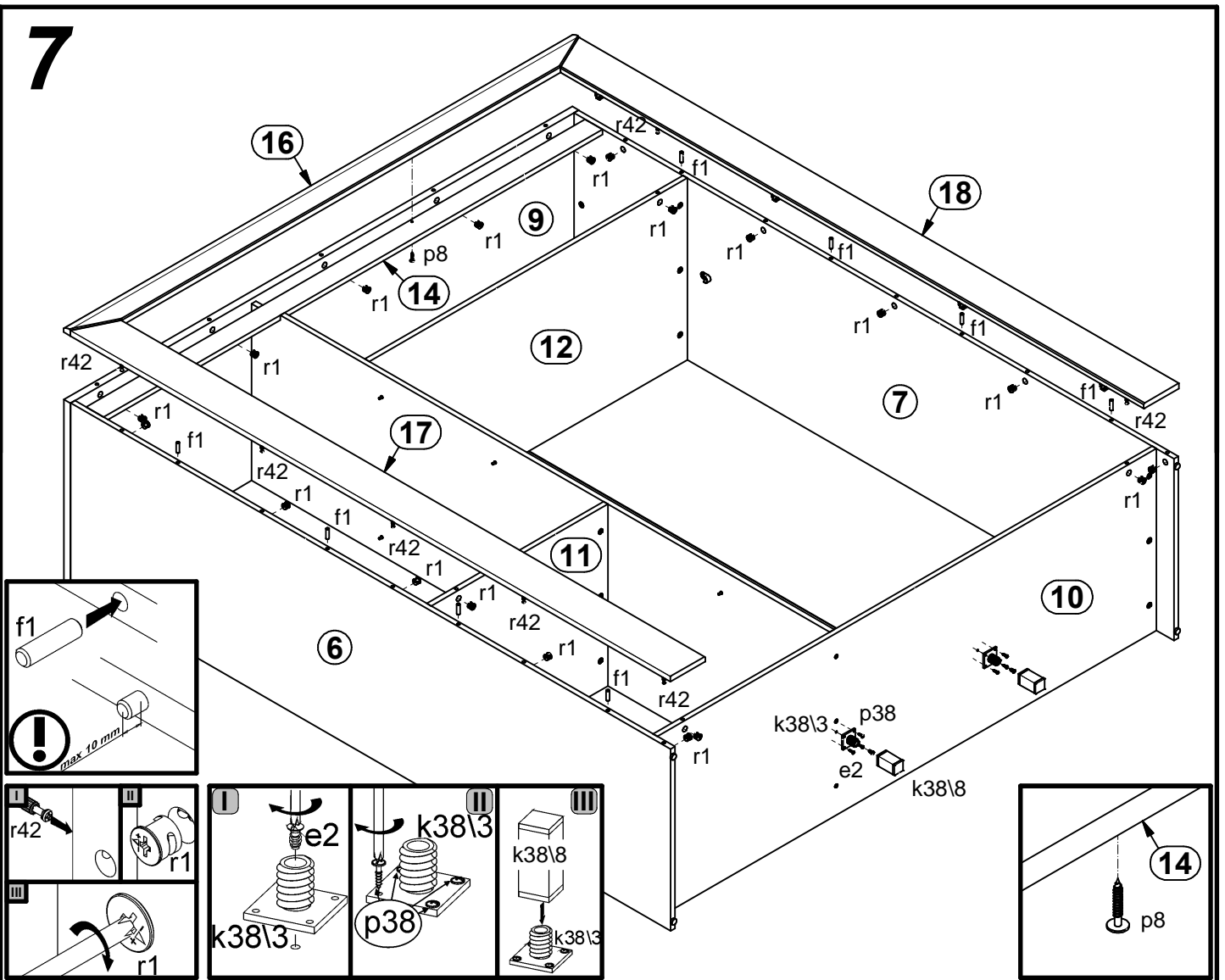

8

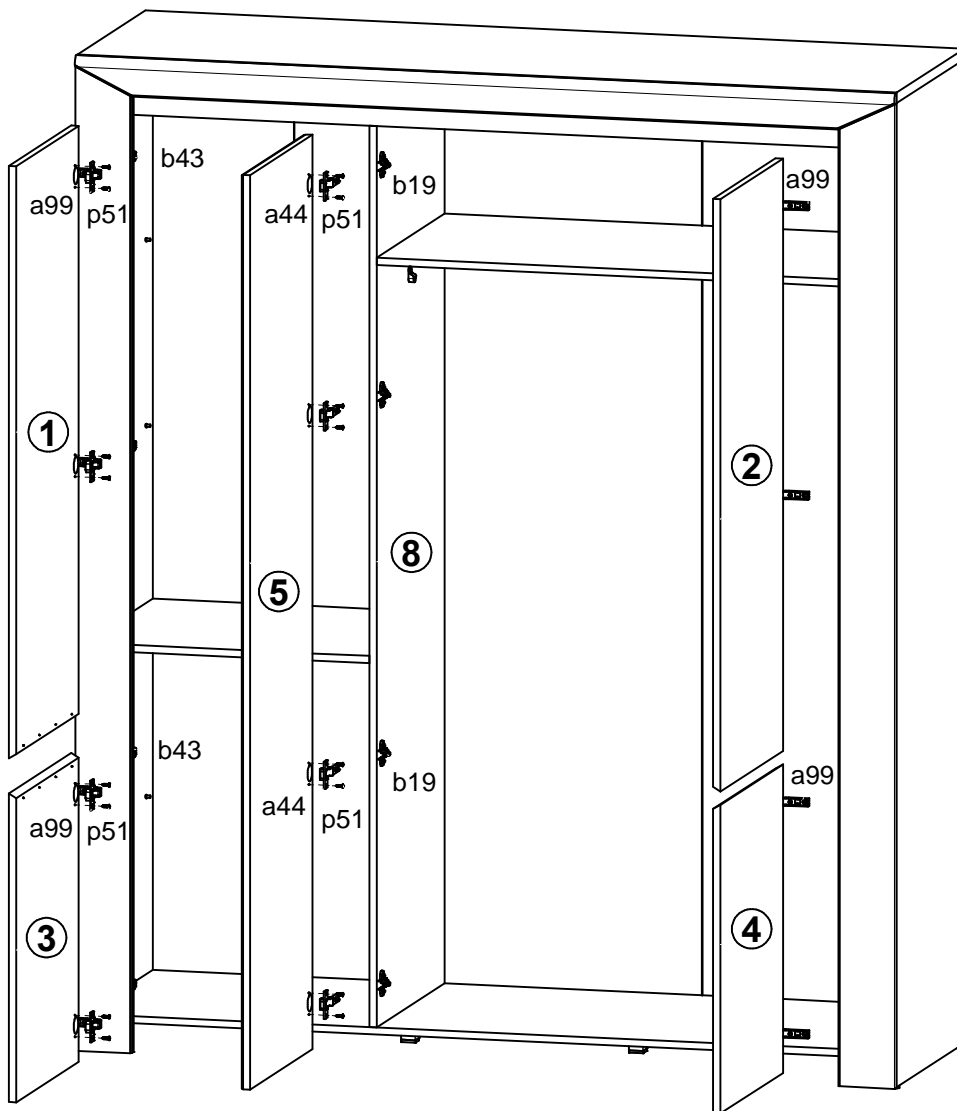
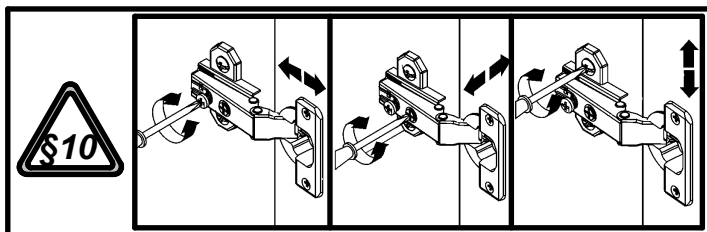
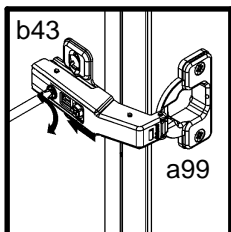
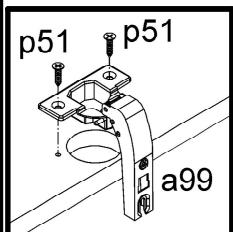
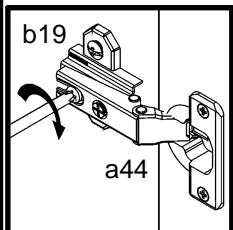
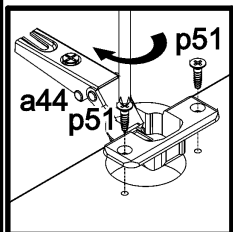
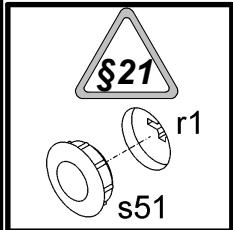
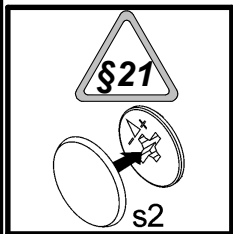

9

