

A	B	C	D
1	S305-003	1140	396
2	S305-004	1140	396
3	S305-005	644	396
4	S305-006	644	396
5	S305-105	1958	540
6	S305-106	1958	540
7	S305-202	1040	540
8	S305-302	1009	540
9	S305-318	1009	540
10	S305-406	1008	60
11	S305-407	396	88
12	S305-502	1041	80
13	S305-514	1958	120
14	S305-515	1958	120
15	S305-903	1915	1033
15	dr-1005	1005	30

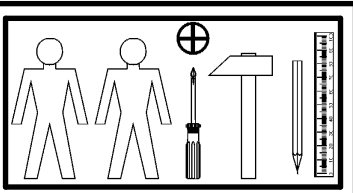

8x a99	8x b43	17x Ø6.3x13 mm e2	28x Ø8x30 mm f1	4x k1	1x k38i3	1x k38i8	70x l1	2x n158
2x Ø3.5x13 mm p1	4x Ø3.5x16 mm p38	16x Ø3.5x15 mm p51	17x Ø4x25 mm p8	39x Ø15x12 mm #16 r1	35x r42	2x r51	22x Ø16 s2	3x Ø15 s51
1x n26i1	1x Ø3.5x16 mm p38							

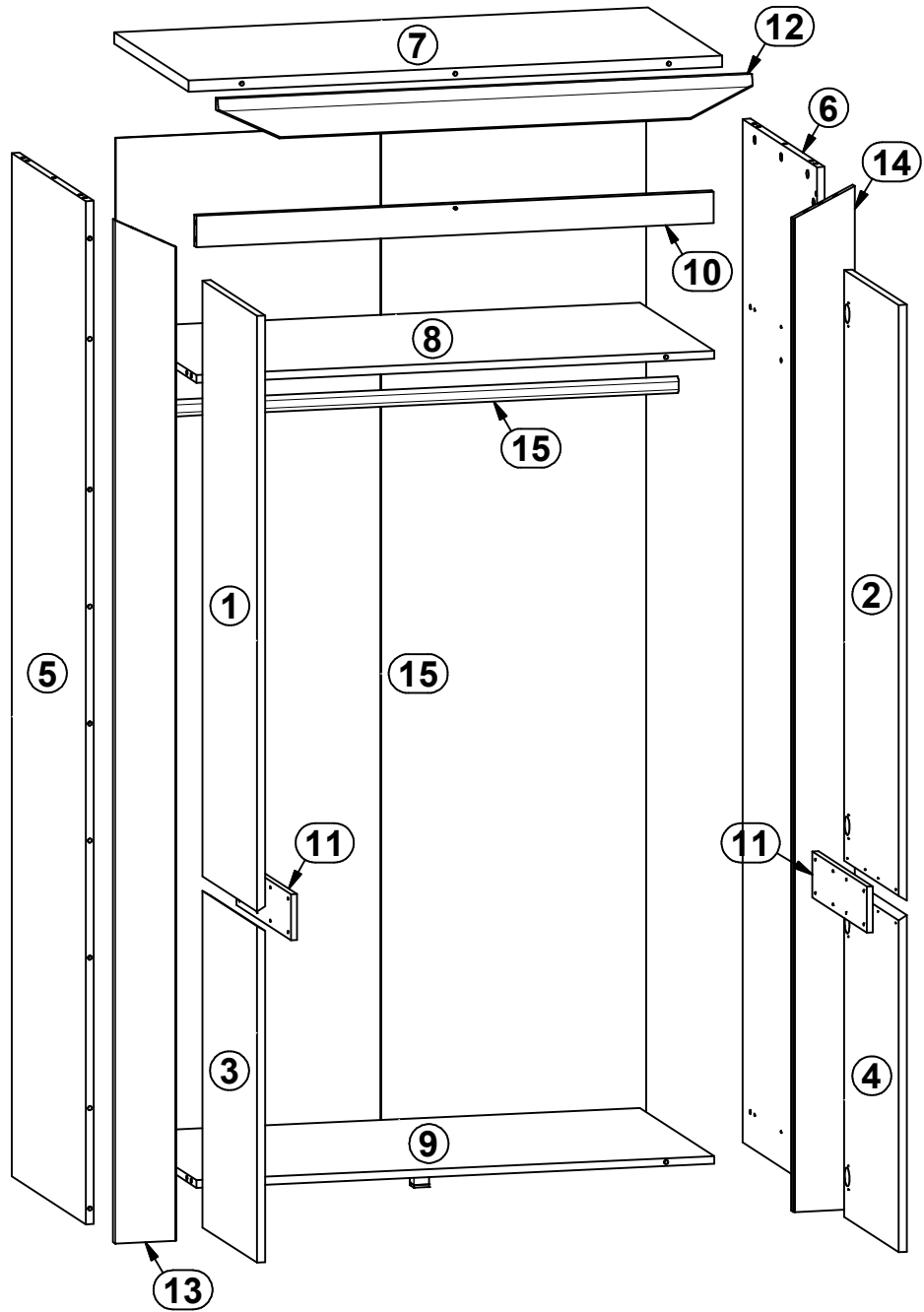
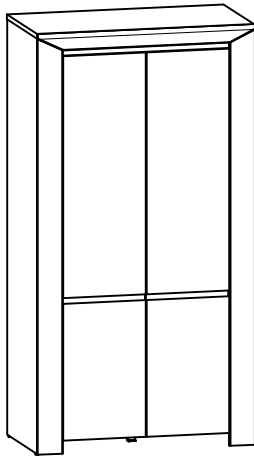
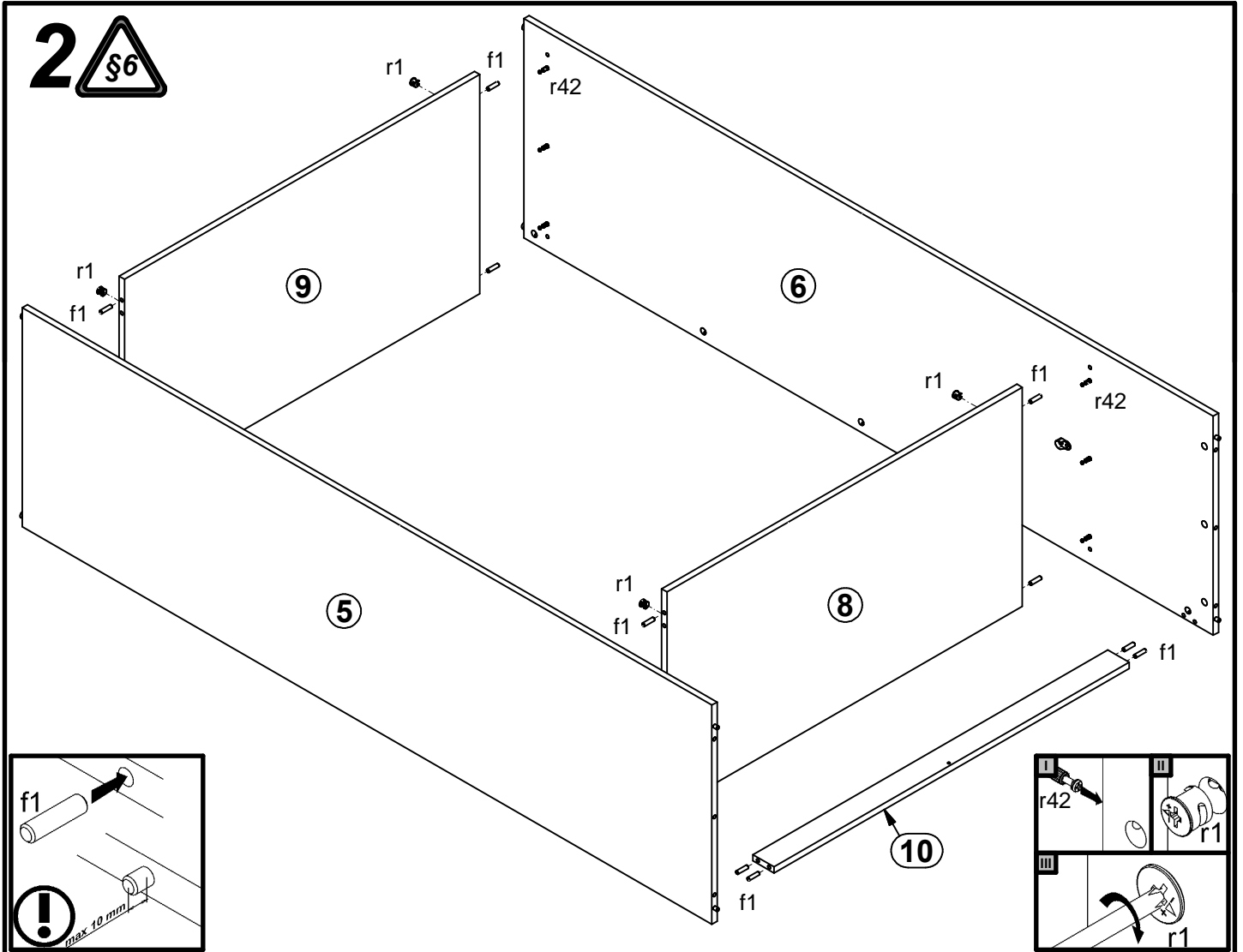
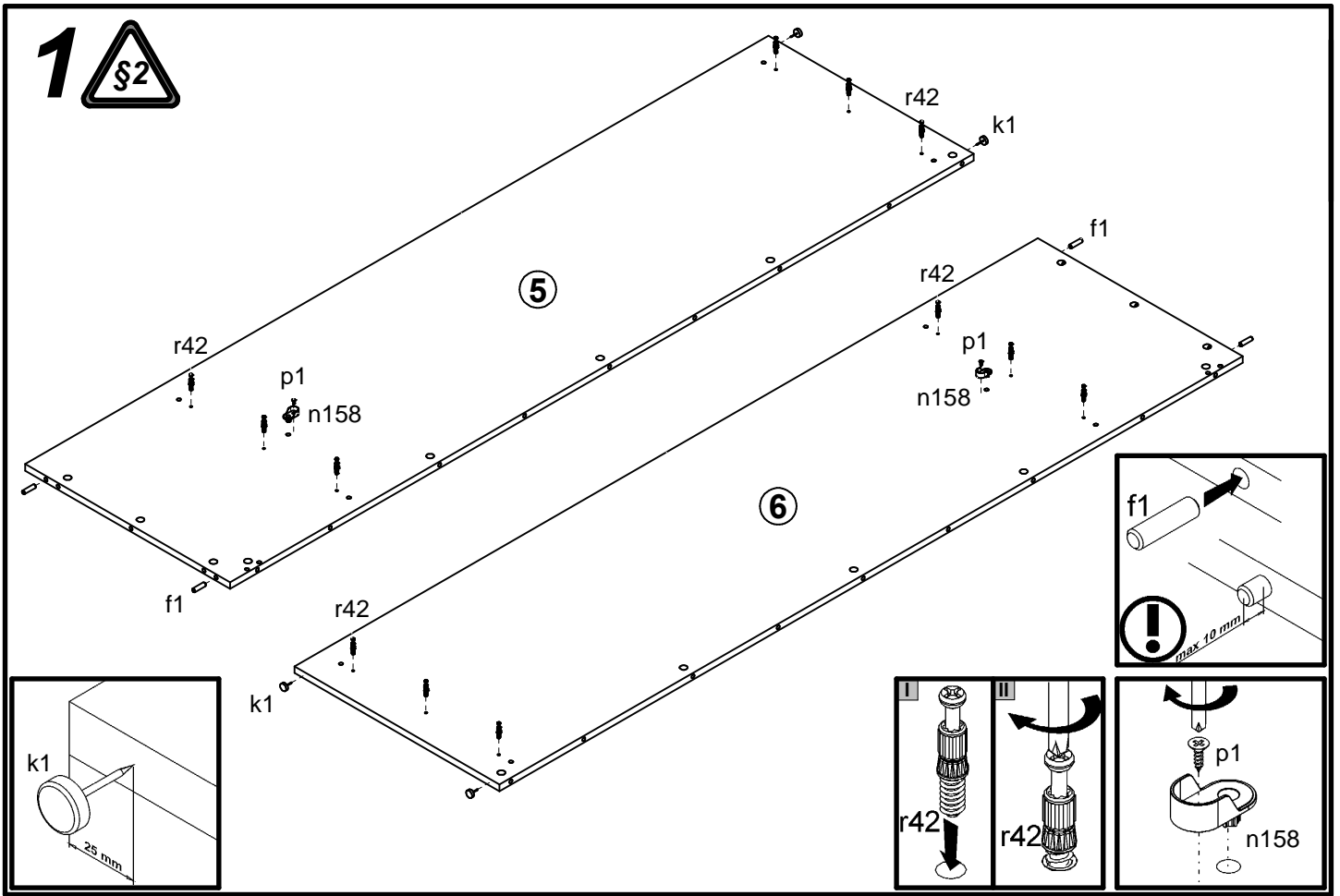

3

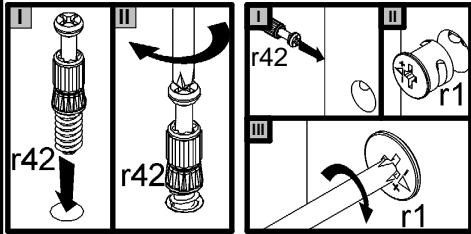
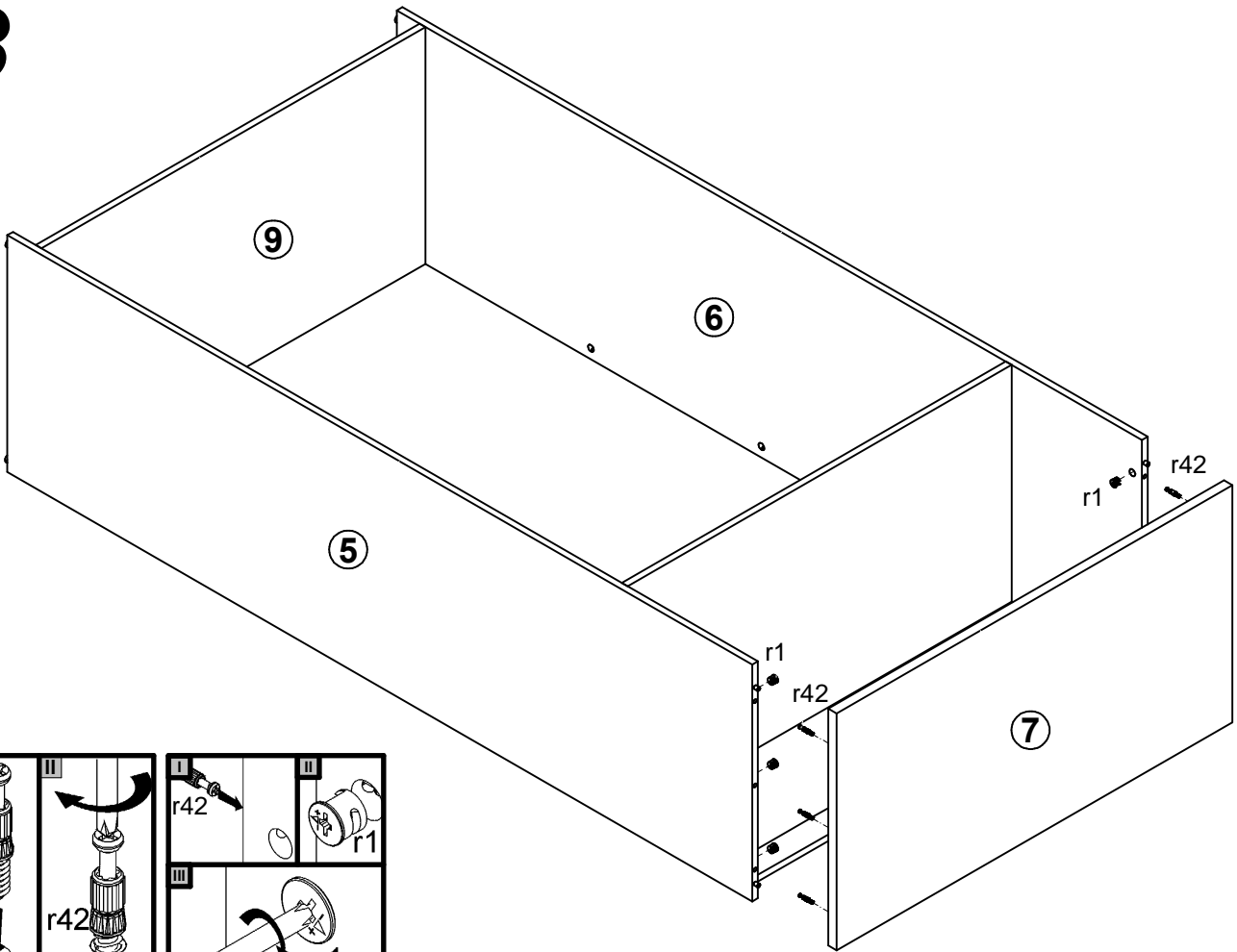

4

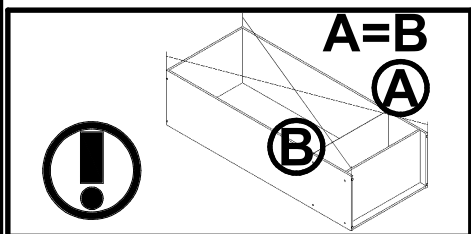
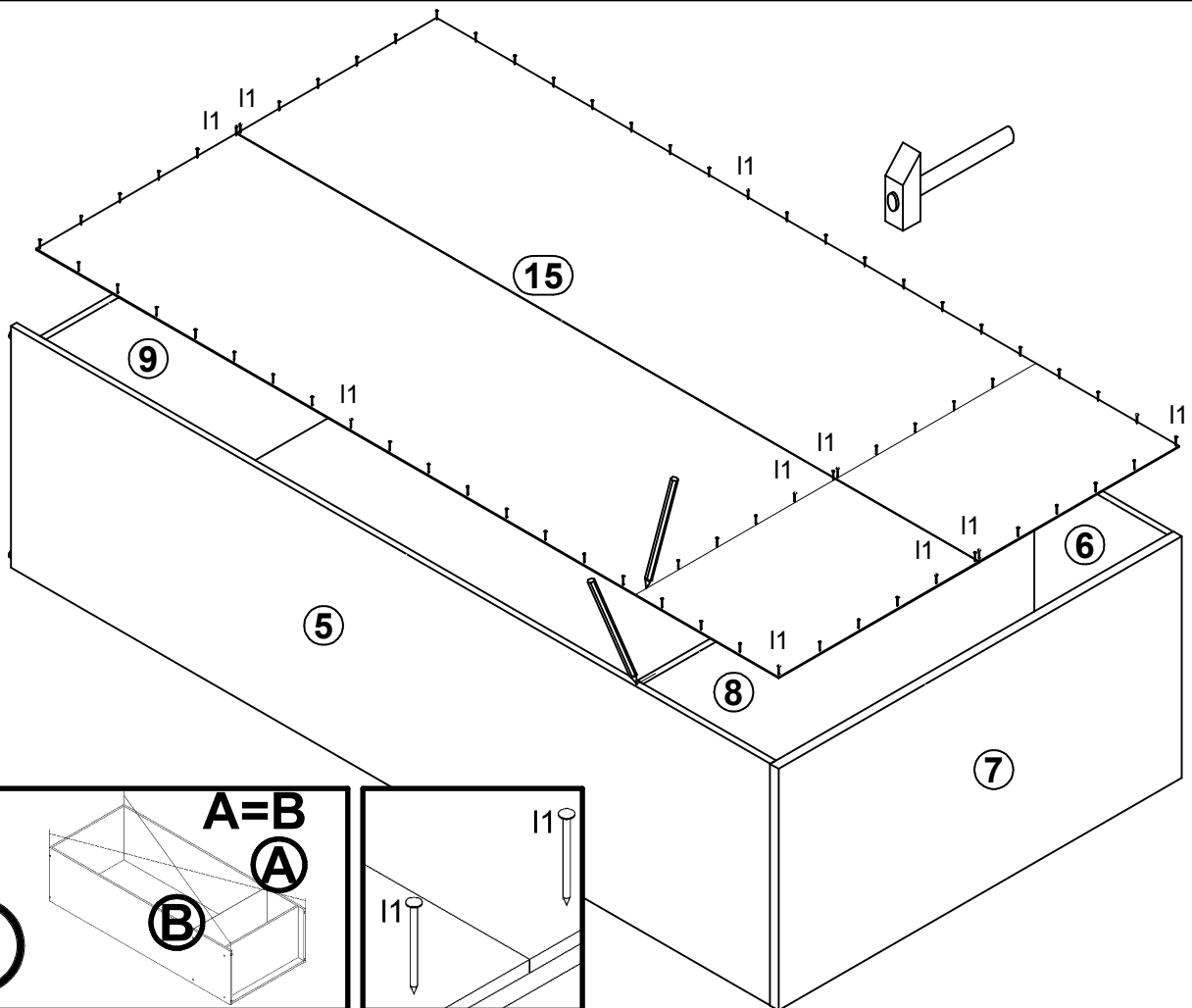

5

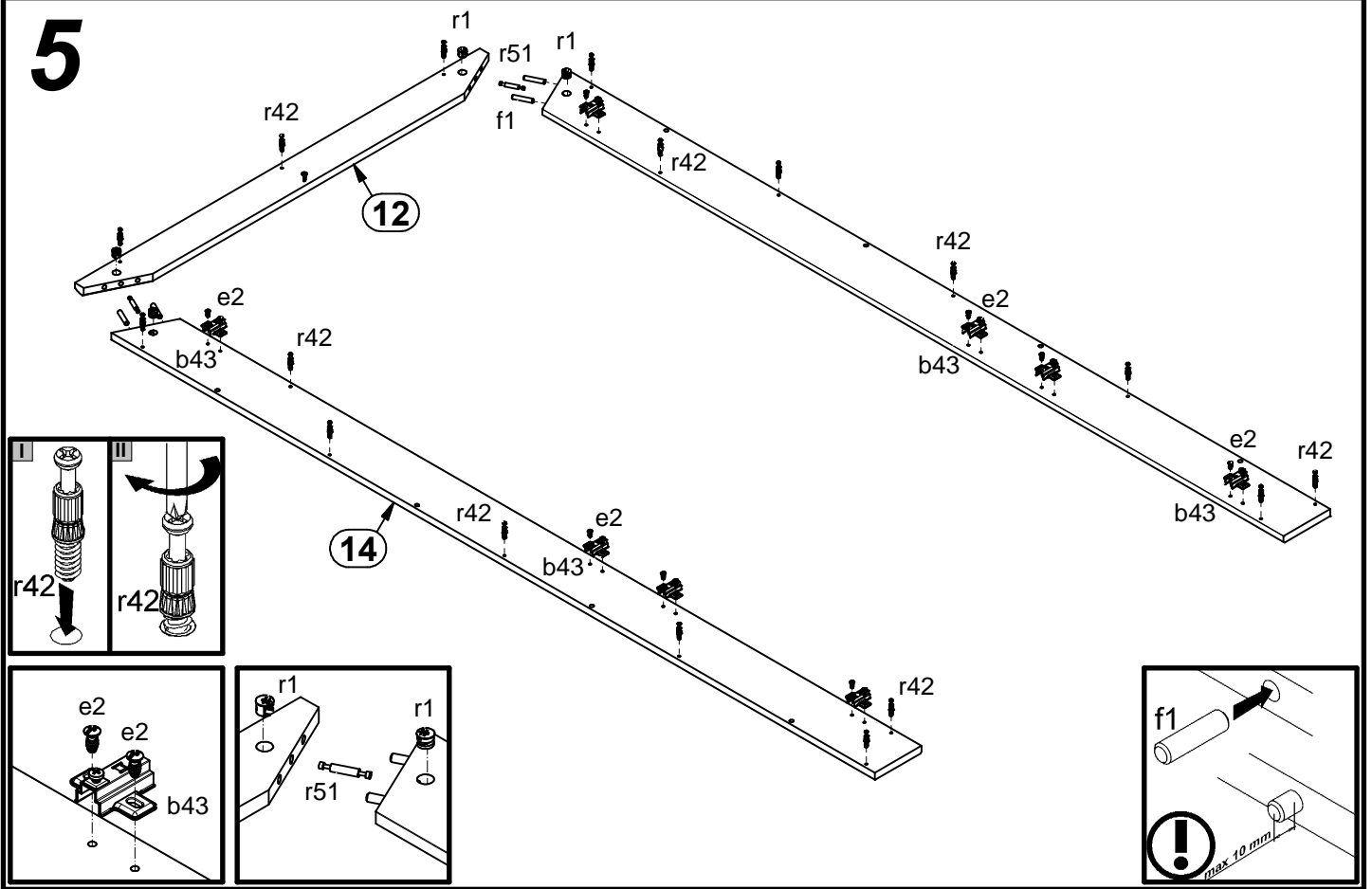

6

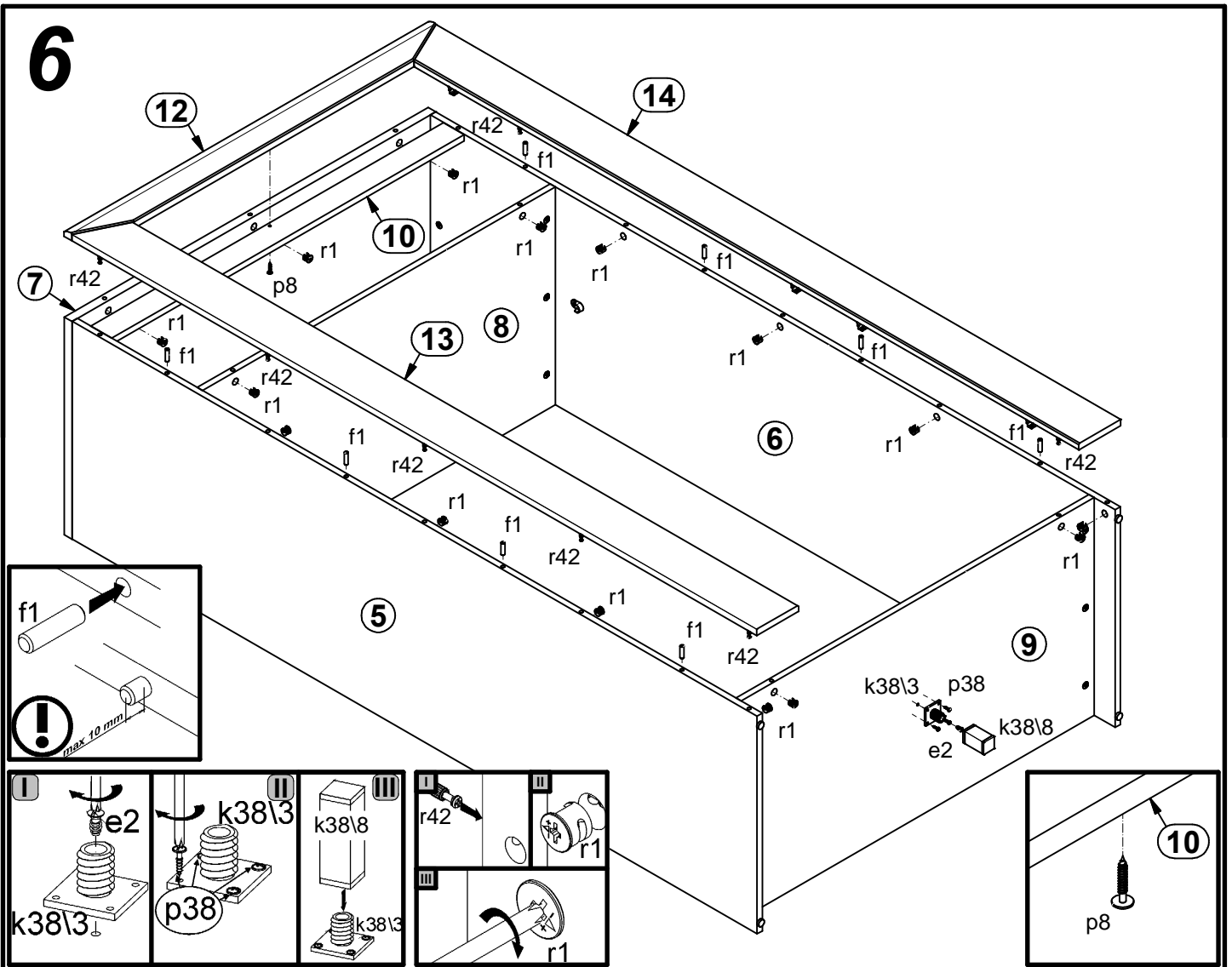

7

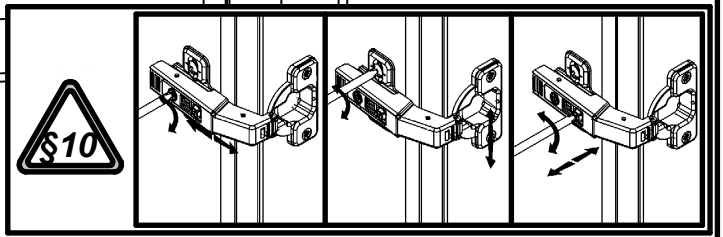
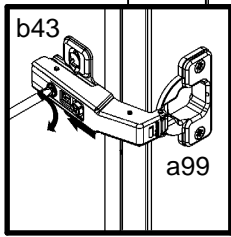
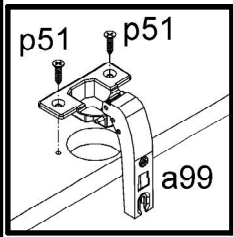
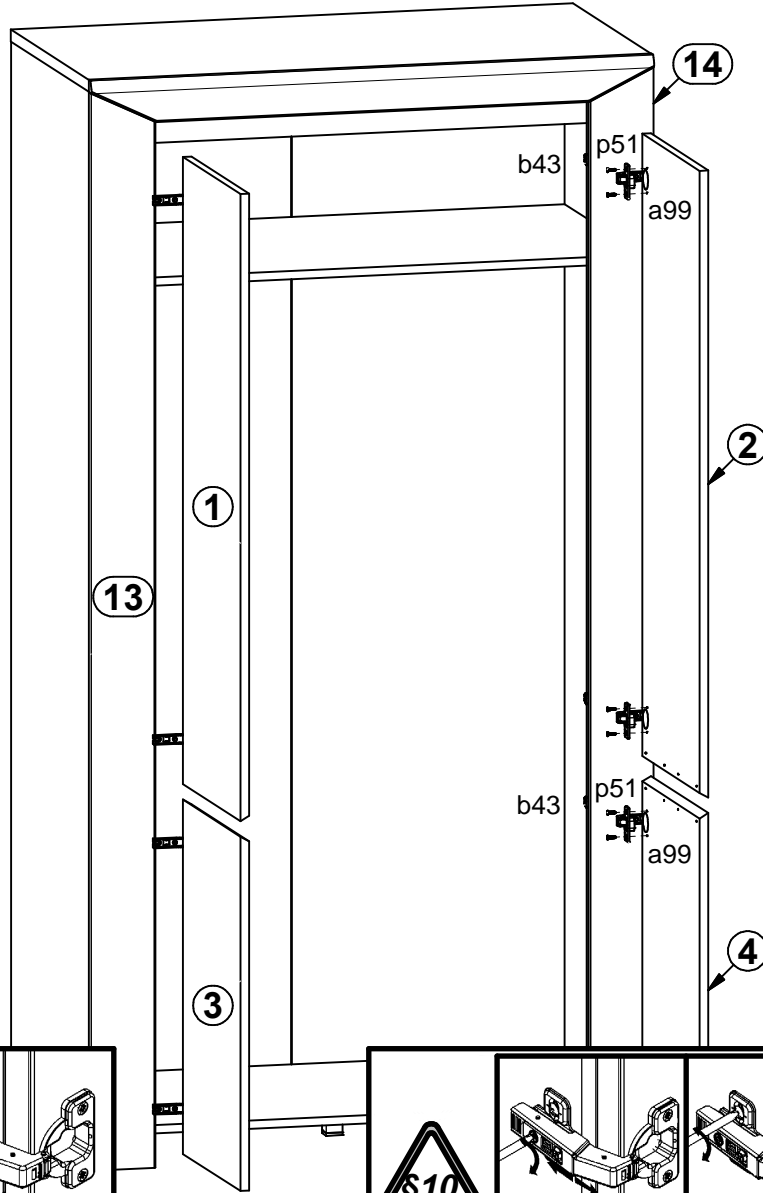

8

