

A**ELPASSO****S314-POL/150**

A	B	C	D
1	S314-313	1494	180
2	S314-403	1500	200

**1** 

2

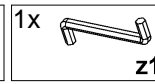
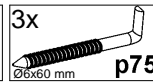
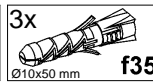
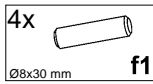
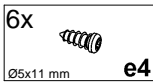
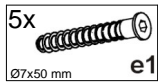
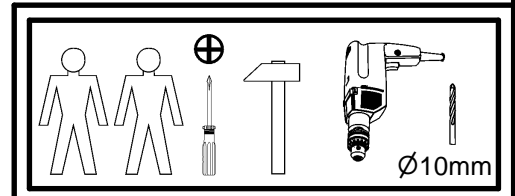
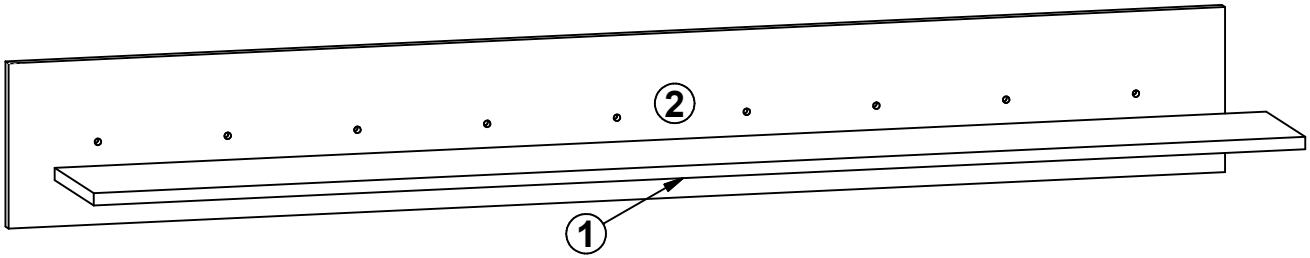
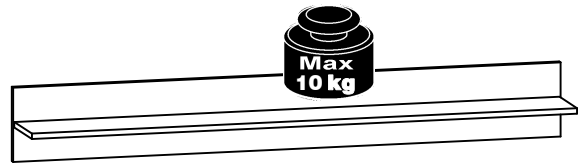
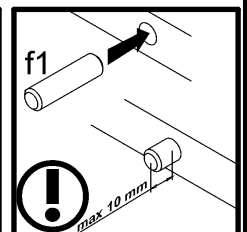
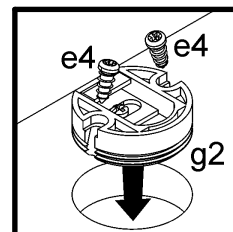
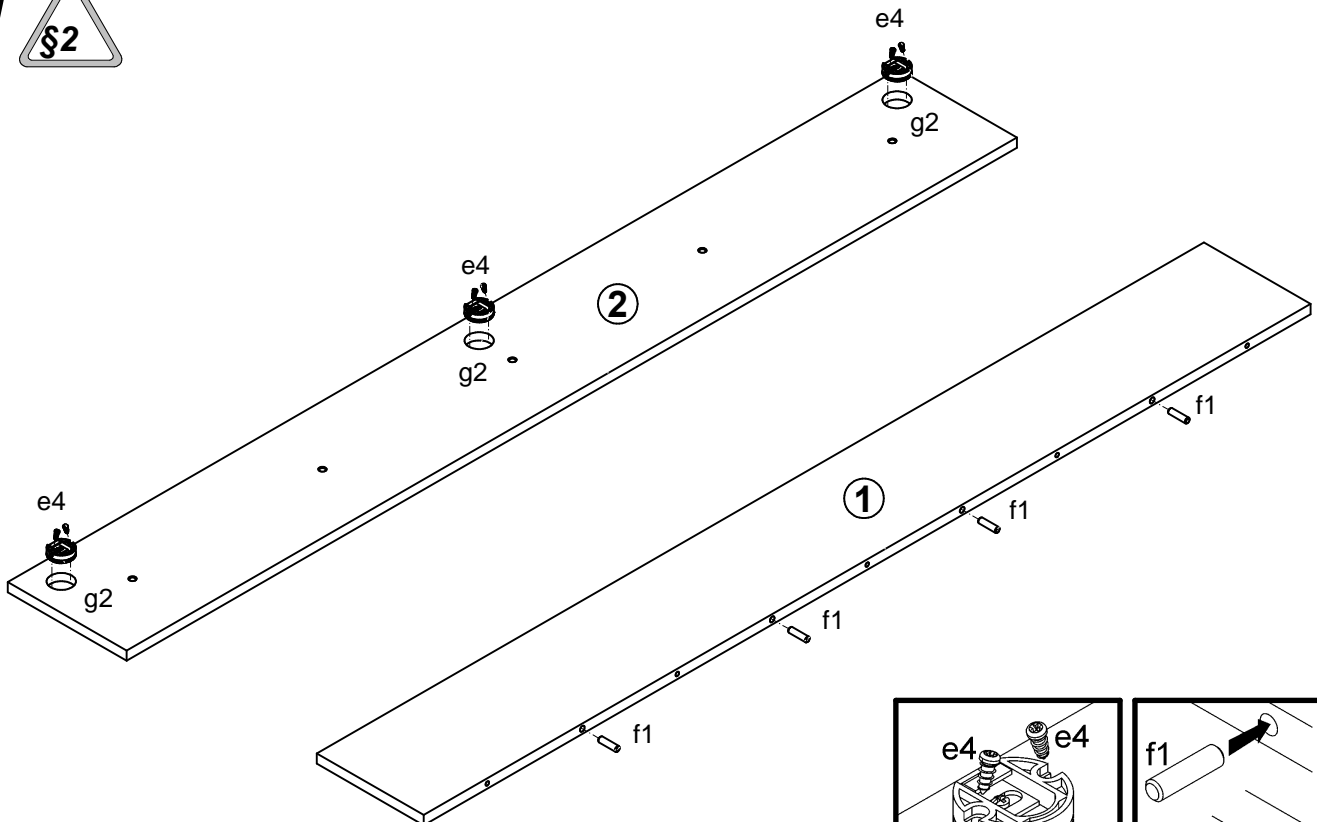
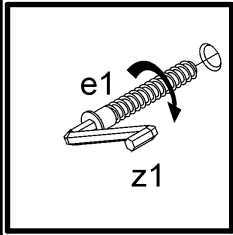
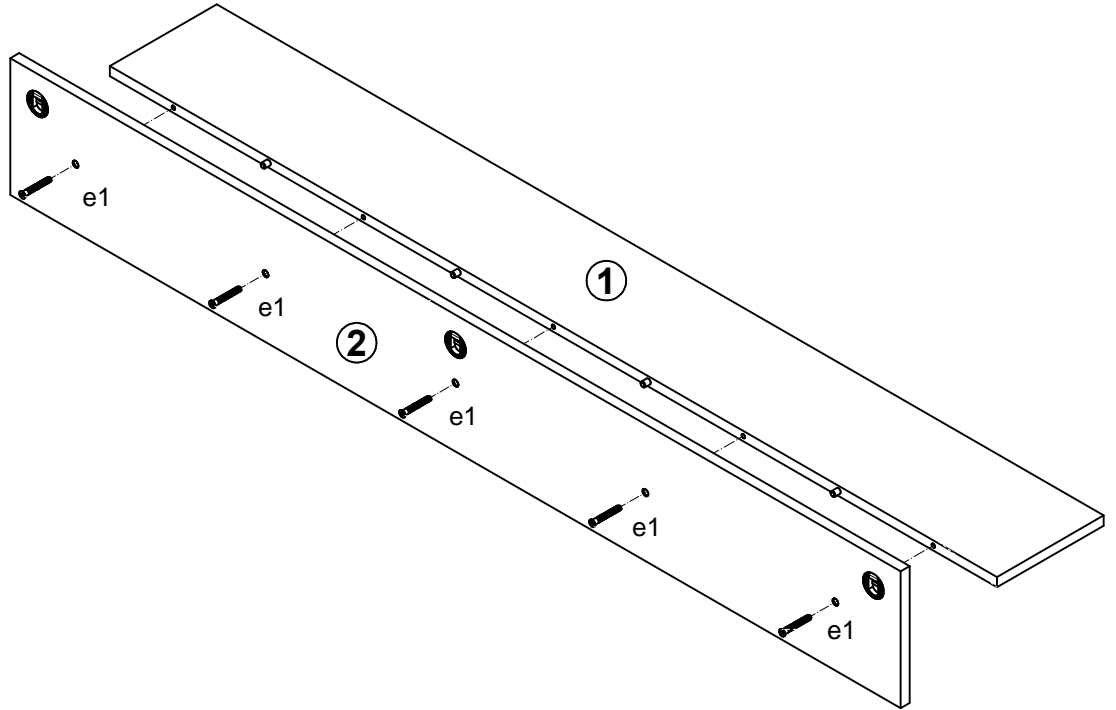

3

