

Podczas montażu
postępować
zgodnie z instrukcją.

While assembling
follow
the instruction.

Montage laut
der Aufbauanleitung
durchführen.

3 NAROŻE 33 ZE SZKŁEM CORNER SHELF UNIT 33 WITH GLASS REGAL 33 MIT GLAS

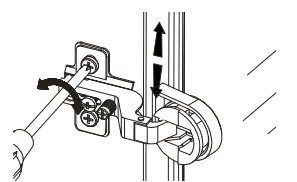

Regulacja drzwi
Adjustment of door
Türeneinstellung

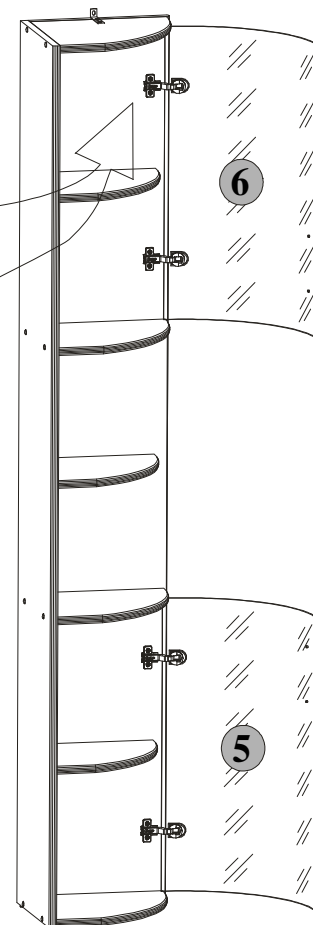
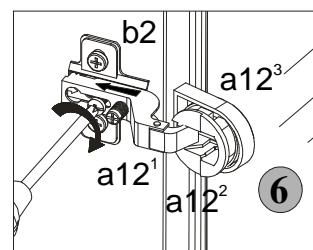
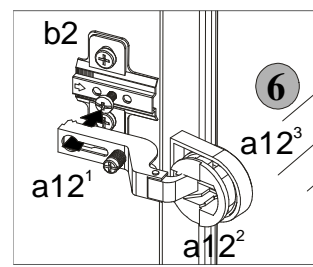
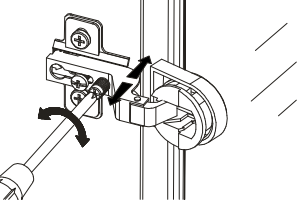
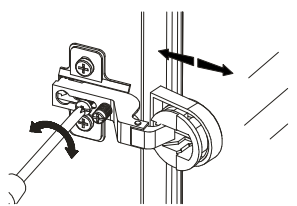

4 NAROŻE 33 ZE SZKŁEM CORNER SHELF UNIT 33 WITH GLASS REGAL 33 MIT GLAS

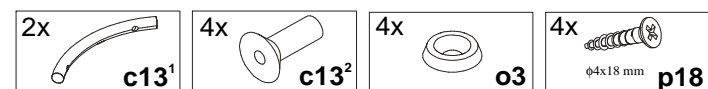
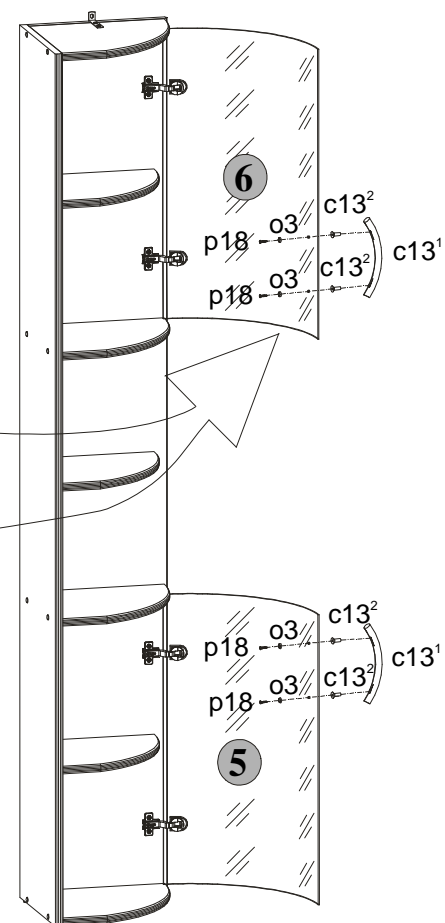
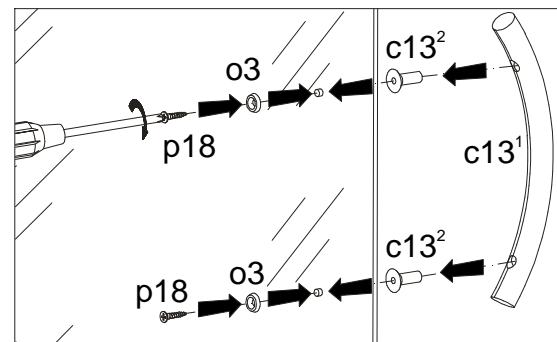

INSTRUKCJA MONTAŻU FITTING-UP INSTRUCTION AUFBAUANLEITUNG

ERYK

NAROŻE 33 ZE SZKŁEM
CORNER SHELF UNIT 33 WITH GLASS
REGAL 33 MIT GLAS



Producent:
BLACK RED WHITE S.A.
UL. KRZESZOWSKA 63
23-400 BILGORAJ



206,5x33x35 [cm]

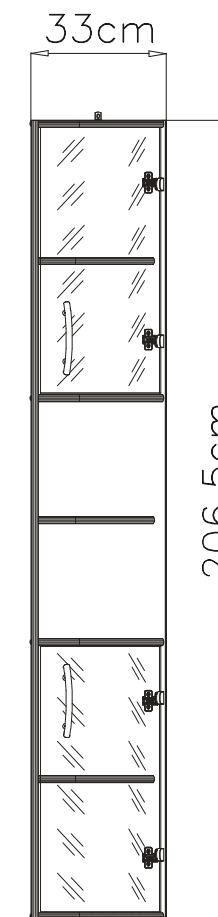
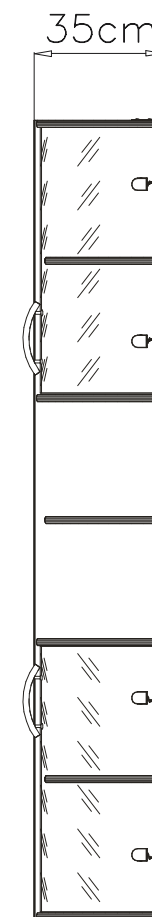

**INSTRUKCJA MONTAZU
FITTING-UP INSTRUCTION
AUFBAUANLEITUNG**

ERYK
NAROŻE 33 ZE SZKŁEM
CORNER SHELF UNIT 33 WITH GLASS
REGAL 33 MIT GLAS

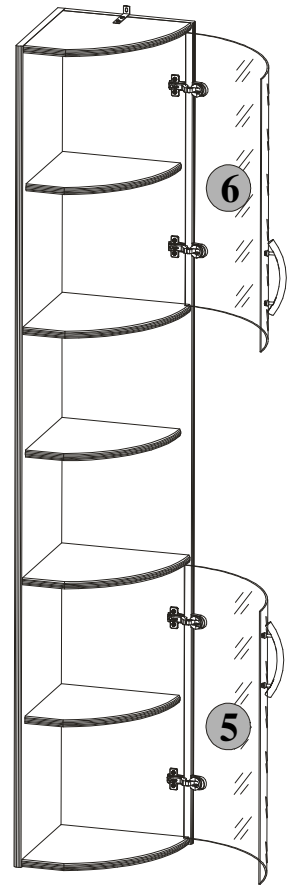

Symbol elementu Element symbol Elementeszeichen	Wymiary Measurements Ausmaß	Kod Code Kode
5	684x492	SM1- 504
6	684x492	SM1- 506

Paczka/Package/Paket - Fronty/Fronts/Möbelfronten
Paczka/Package/Paket - Akcesoria/Accessories/Zubehör

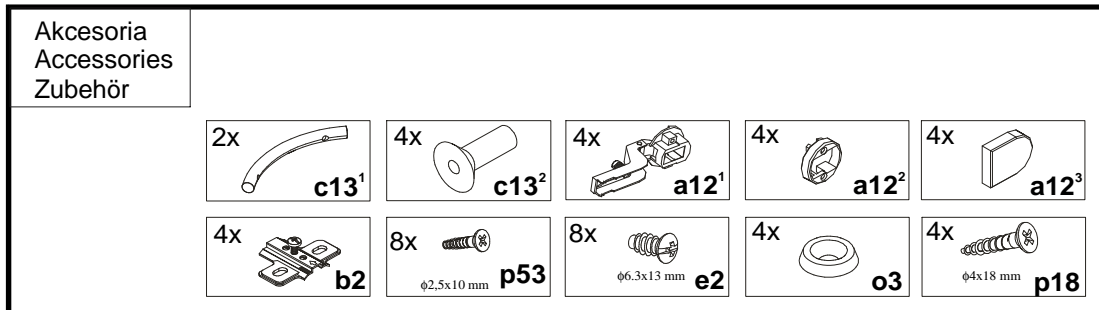
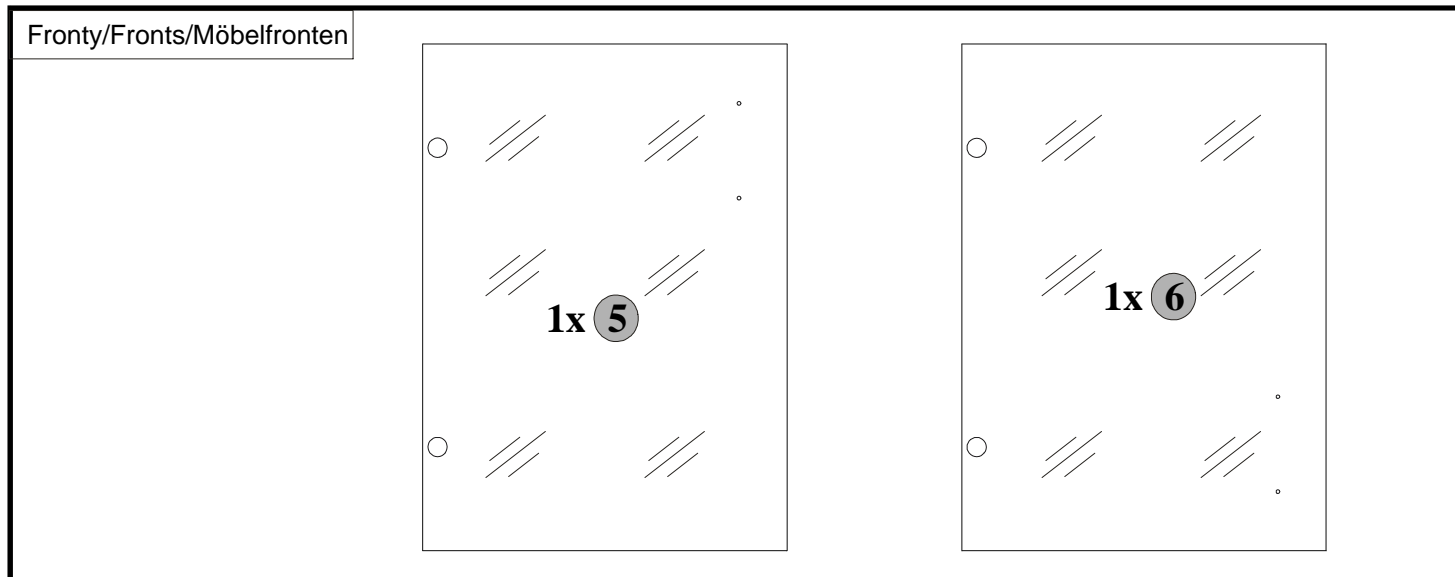

Podczas montazu
postepowac
zgodnie z instrukcja.

While assembling
follow
the instruction.

Montage laut
der Aufbauanleitung
durchföhren.

