

A	B	C	D
1	S181-024	496	188
2	S181-133	162	377
3	S181-136	318	400
4	S181-137	318	381
5	S181-217	578	400
6	S181-229	578	400
7	S181-323	539	395
8	S181-508	318	94
9	S181-916	340	561
10	S181-917	433	356
11	ZT1-501	350	120
12	ZT1-502	350	120
13	ZT1-512	423	106

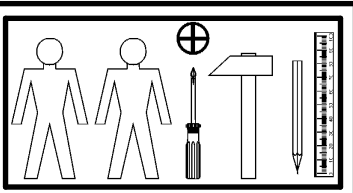

1x  c352	4x  Ø6x13 mm e3	4x  Ø7x60 mm e8	20x  Ø8x30 mm f1	4x  Ø6.5x40 mm f25	2x  M4x25 mm j8	4x  M6/Ø14x14 mm k39/2	4x  M6/22 mm k39/3	25x  l1
4x  Ø3.5x16 mm p38	10x  Ø15x12 mm #16 r1	4x  Ø12x10.5 mm #12 r15	14x  r42	5x  Ø 20mm s68	1x  360 mm w98/1L	1x  360 mm w98/1P	1x  z1	

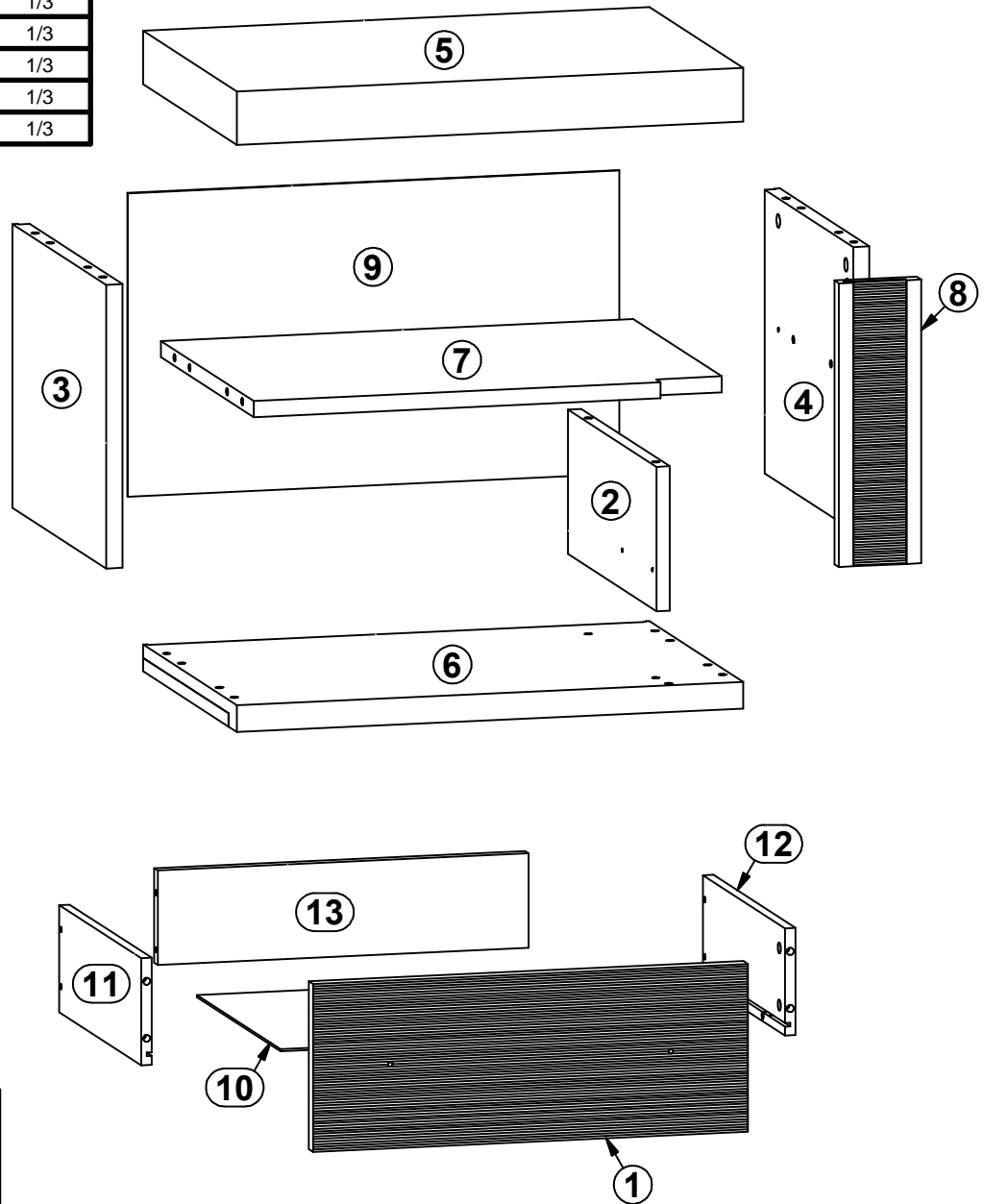
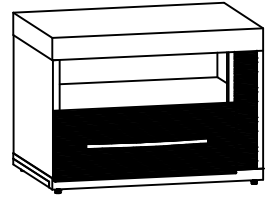
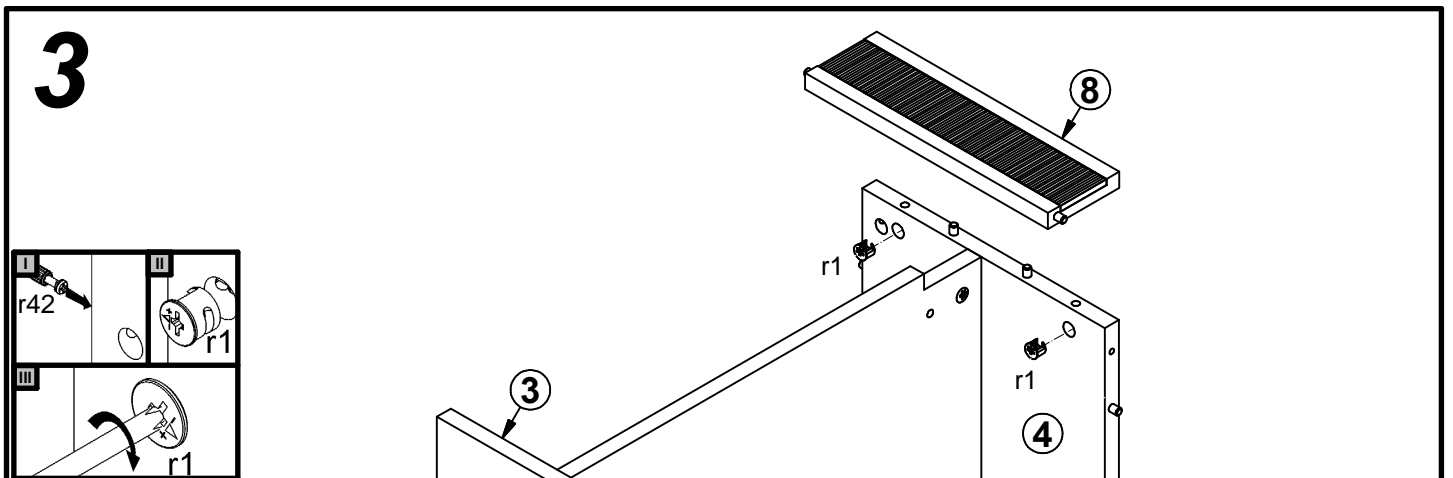
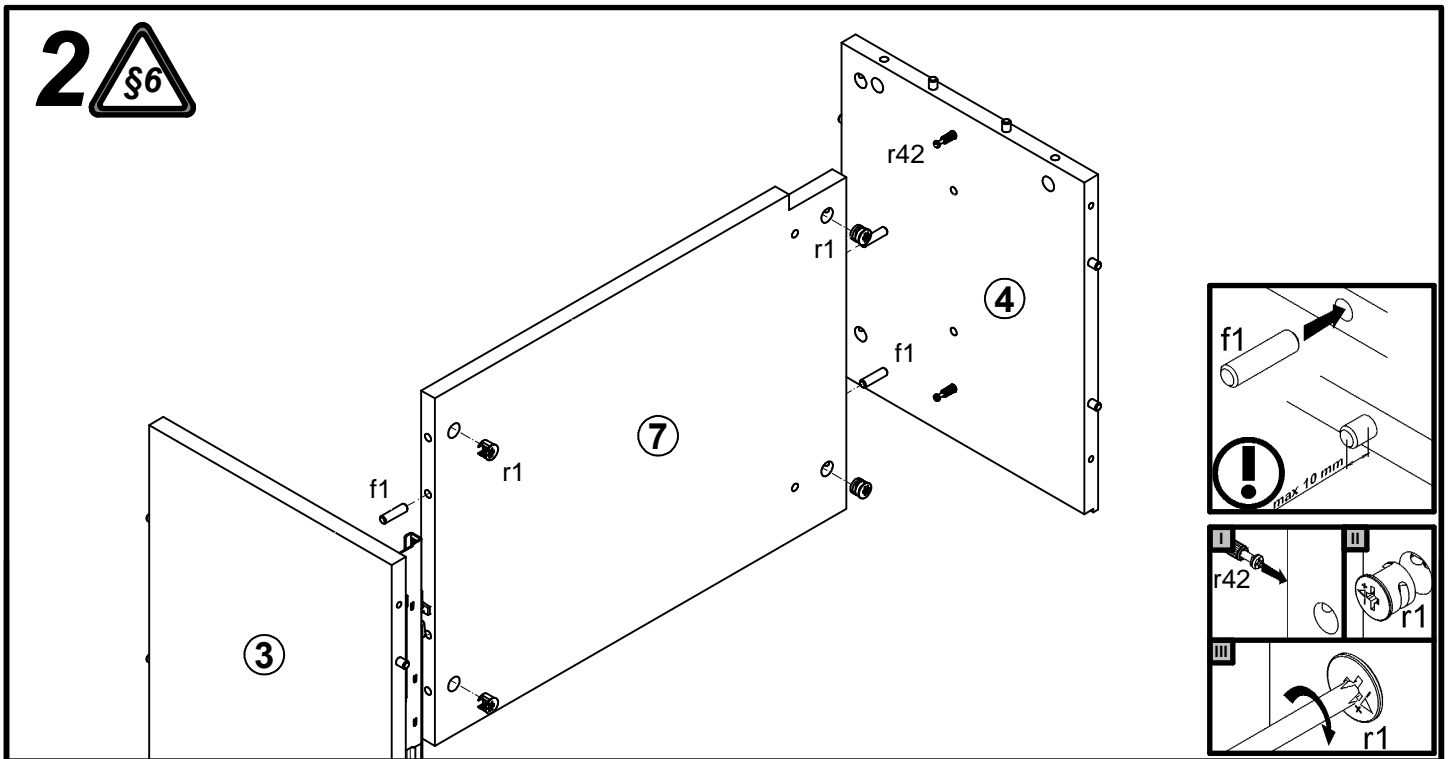
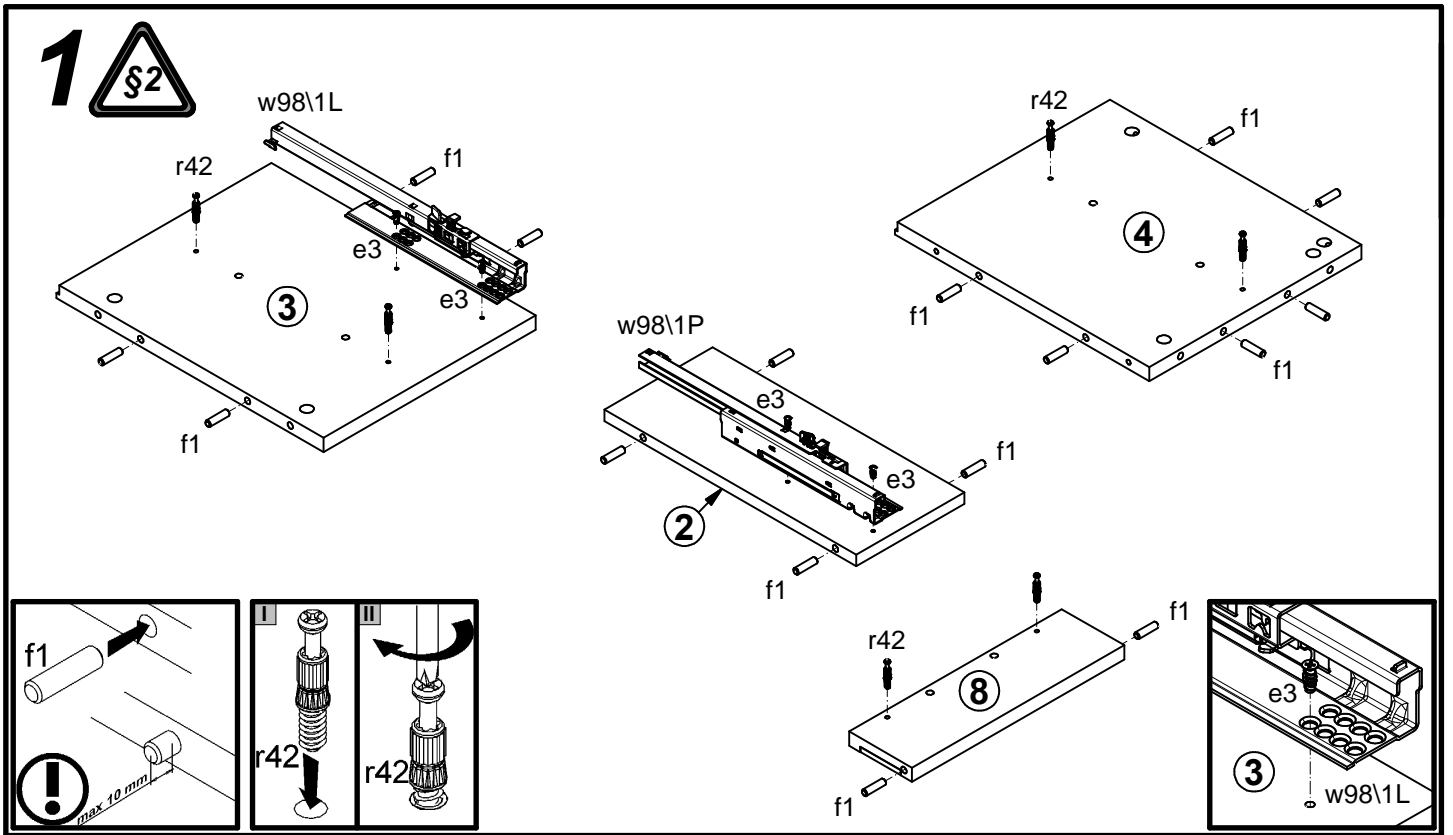

# 4

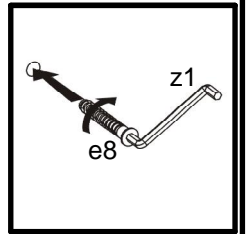
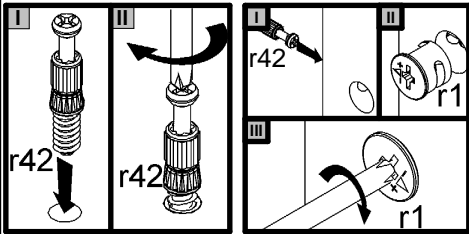
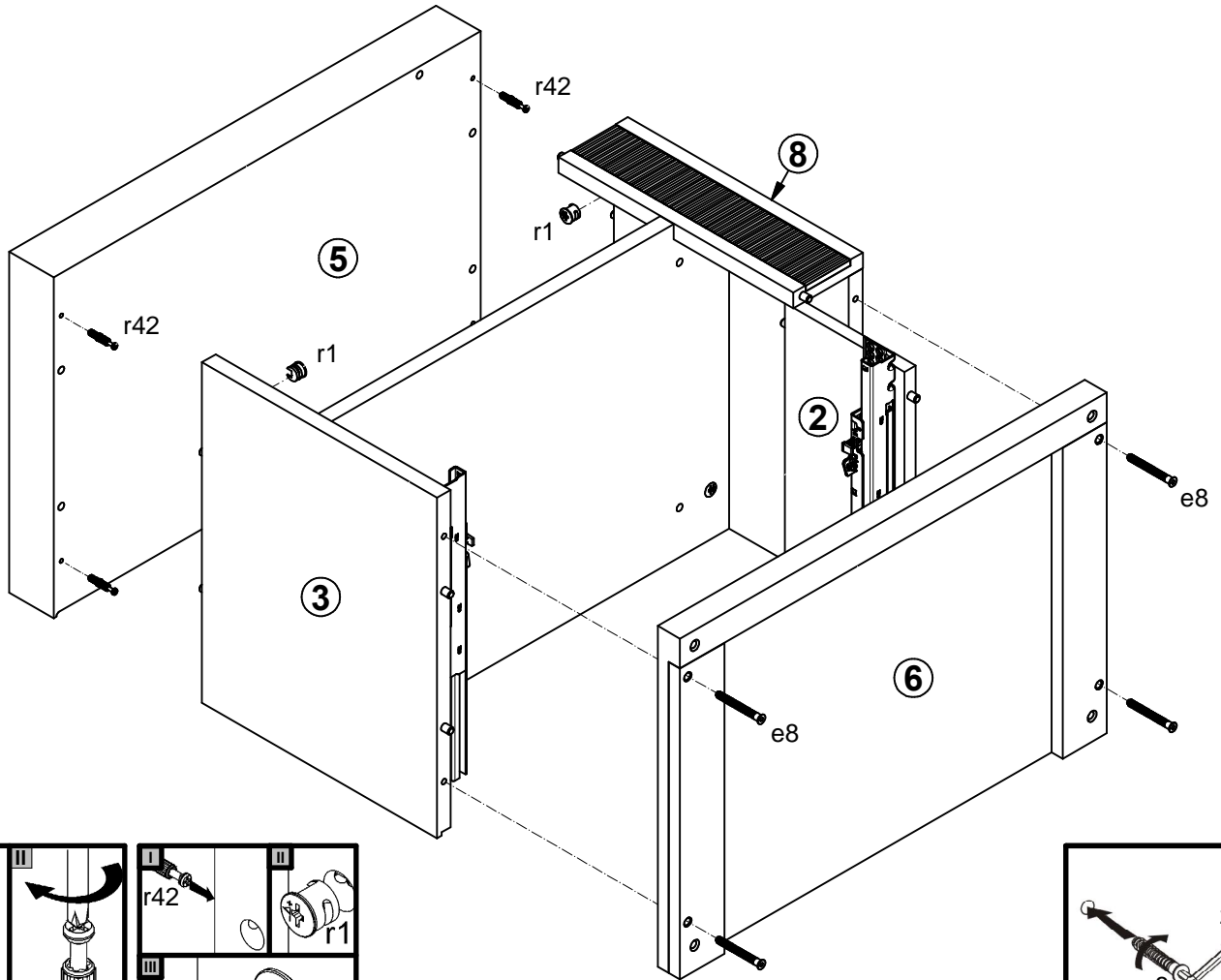

# 5

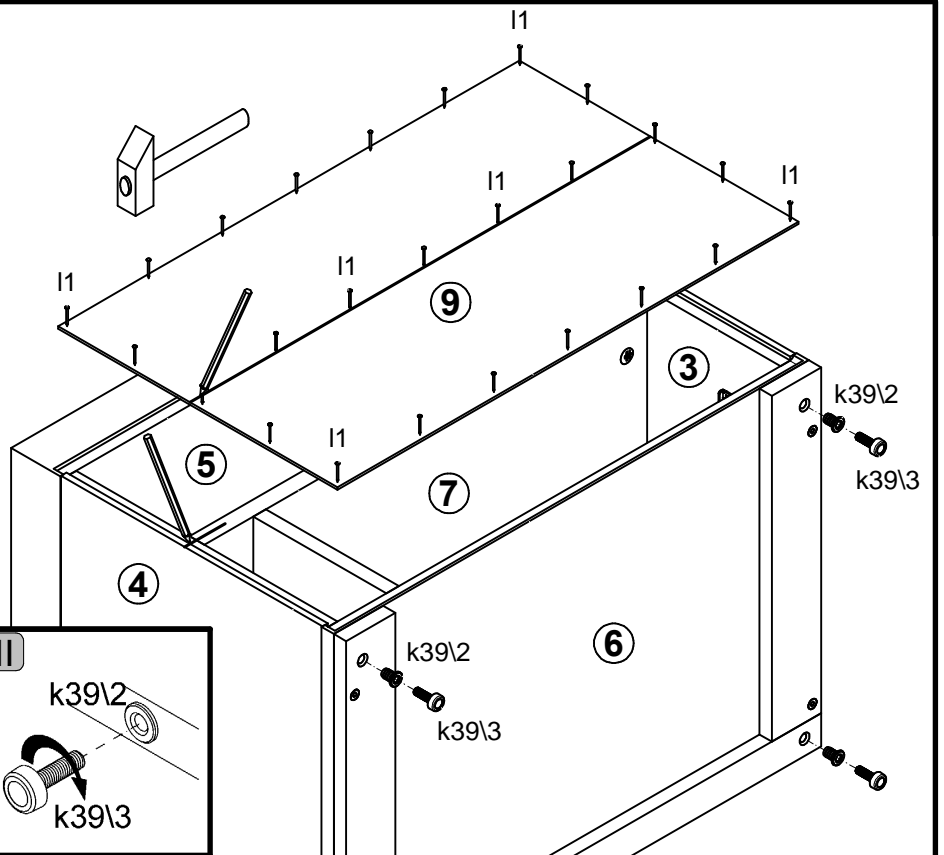
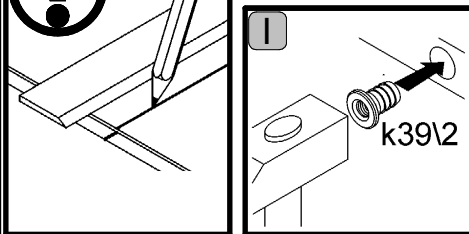
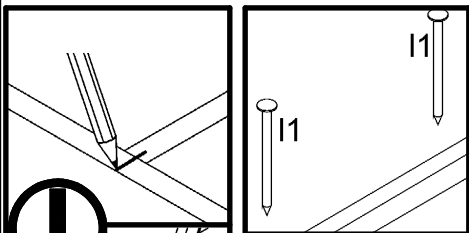
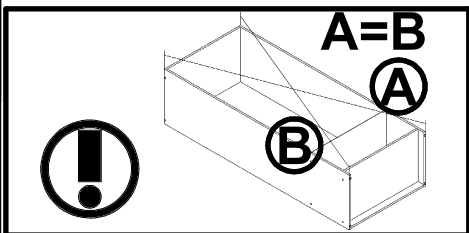

# 6

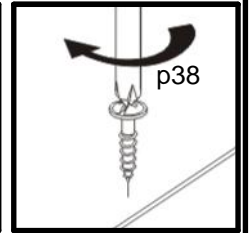
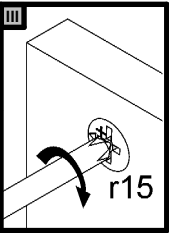
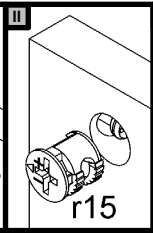
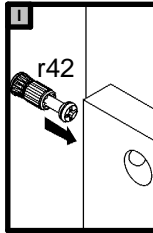
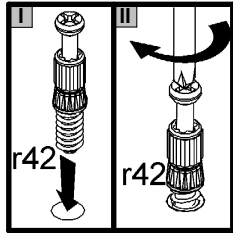
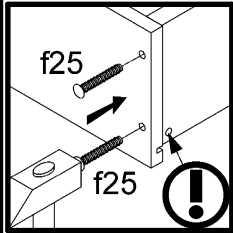
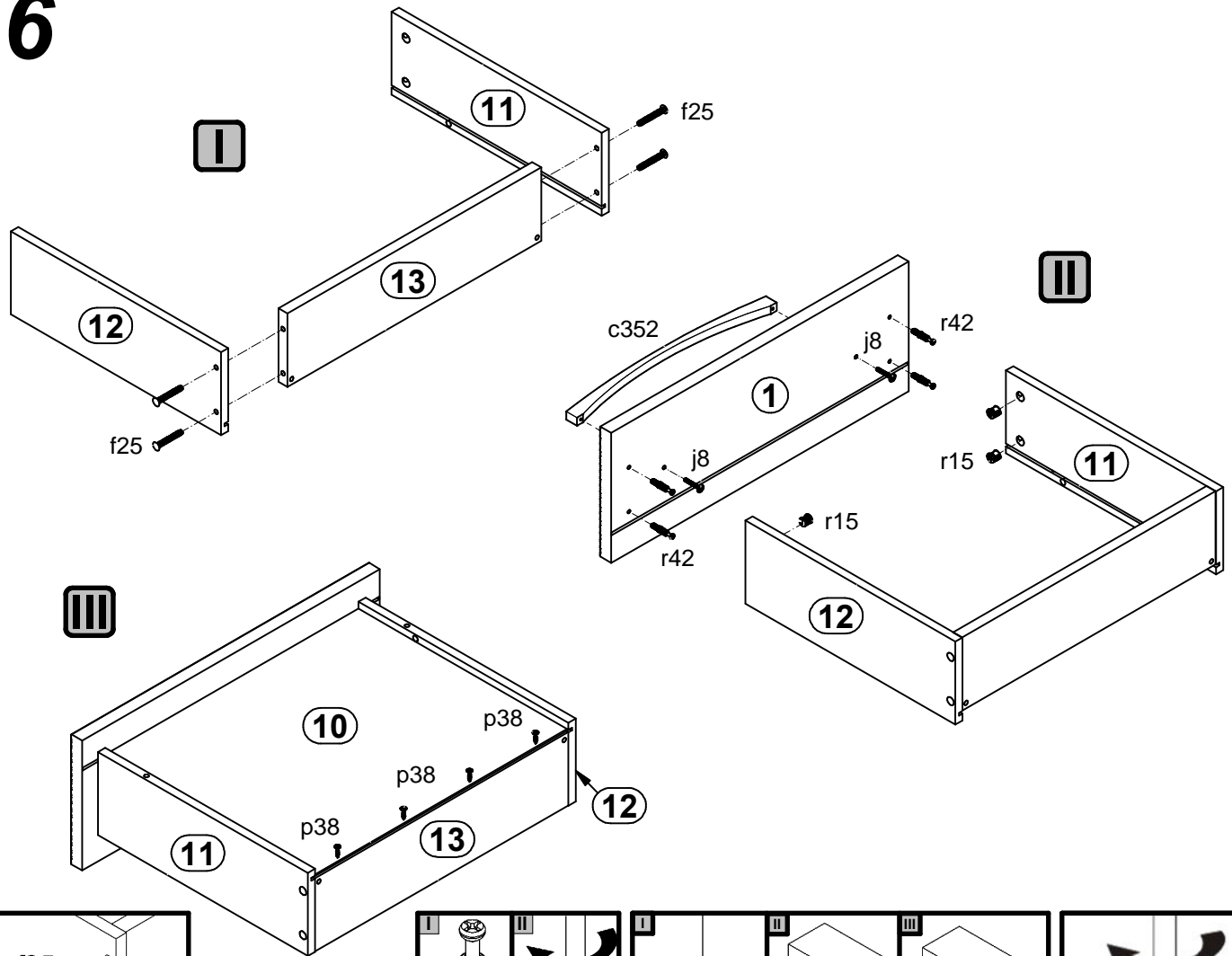

# 7

