

A	B	C	D
1	S181-001	496	764
2	S181-002	496	764
3	S181-102	1904	381
4	S181-106	1904	400
5	S181-203	578	400
6	S181-205	578	400
7	S181-301	538	395
8	S181-304	537	376
9	S181-502	1904	94
10	S181-904	1926	559

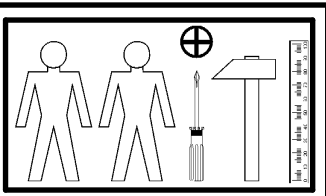

4x a113	4x b54	2x c352	8x Ø5x17 mm d1	22x Ø8x30 mm f1	4x M4x25 mm j8	4x M6/Ø14x14 mm k39 2	4x M6/22 mm k39 3	65x l1
8x Ø3.5x15 mm p51	20x Ø15x12 mm #16 r1	20x r42	20x Ø 20mm s68	1x n26 1	1x Ø3.5x16 mm p38			

1 §2 §11

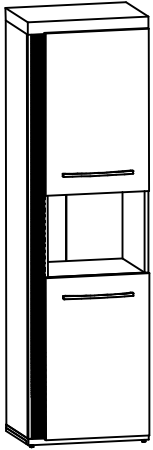
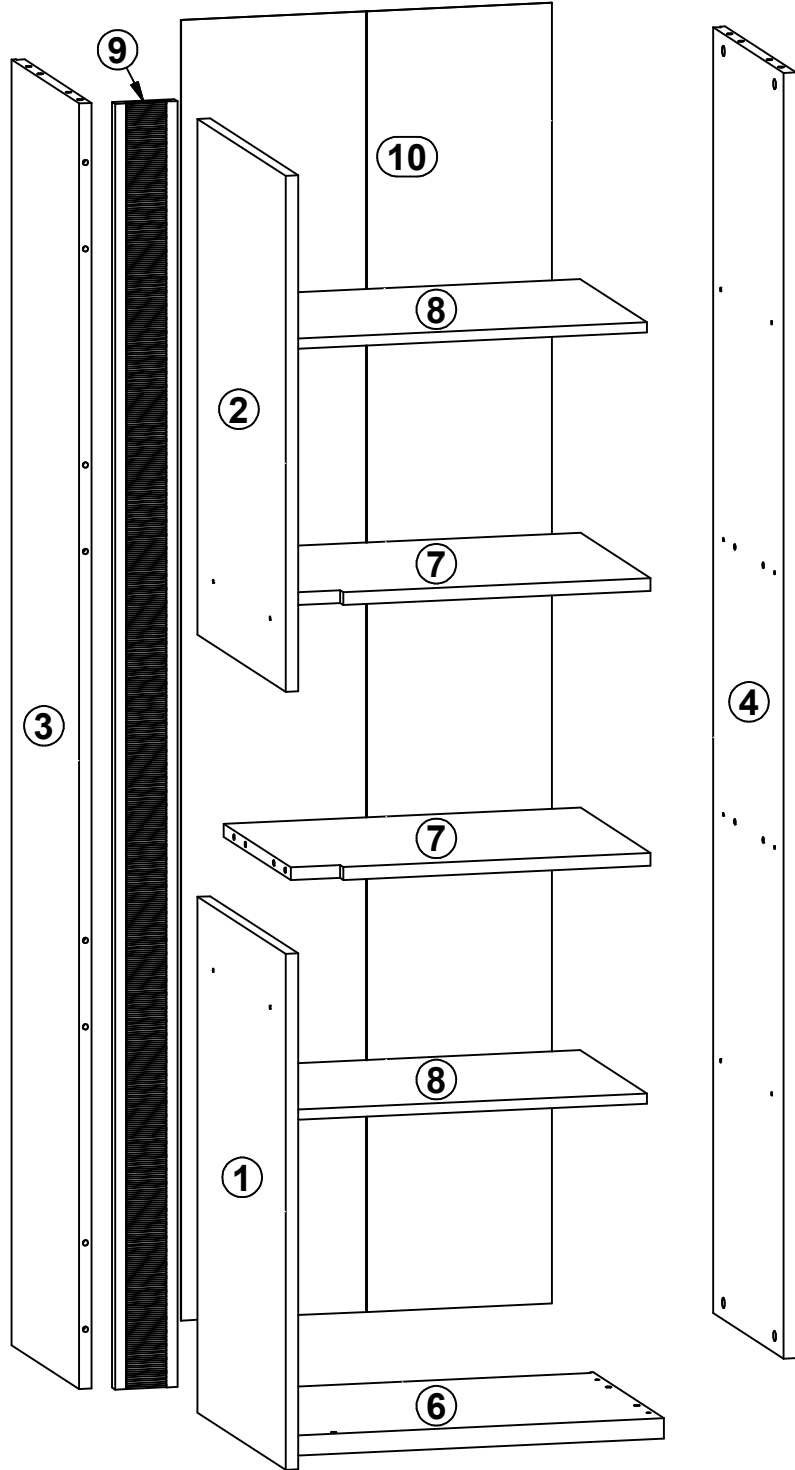
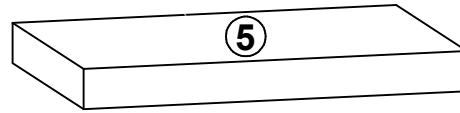
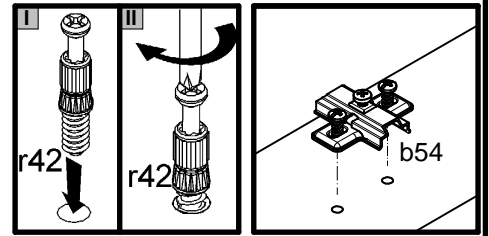
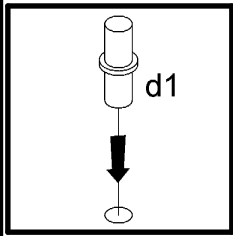
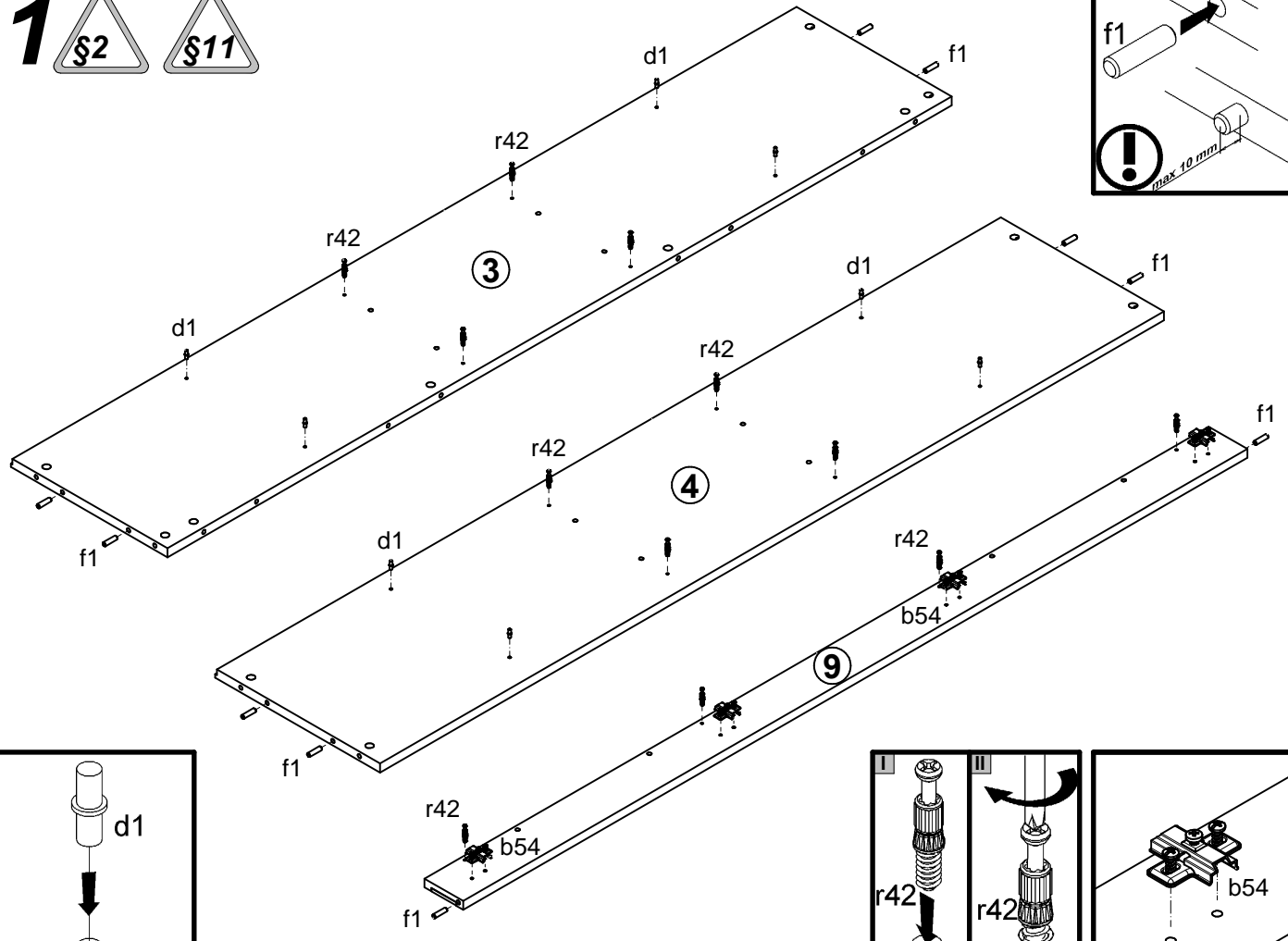

2 §6

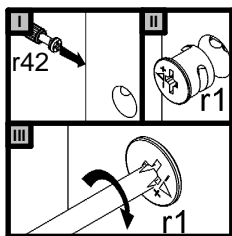
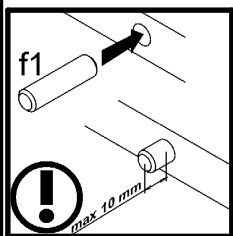
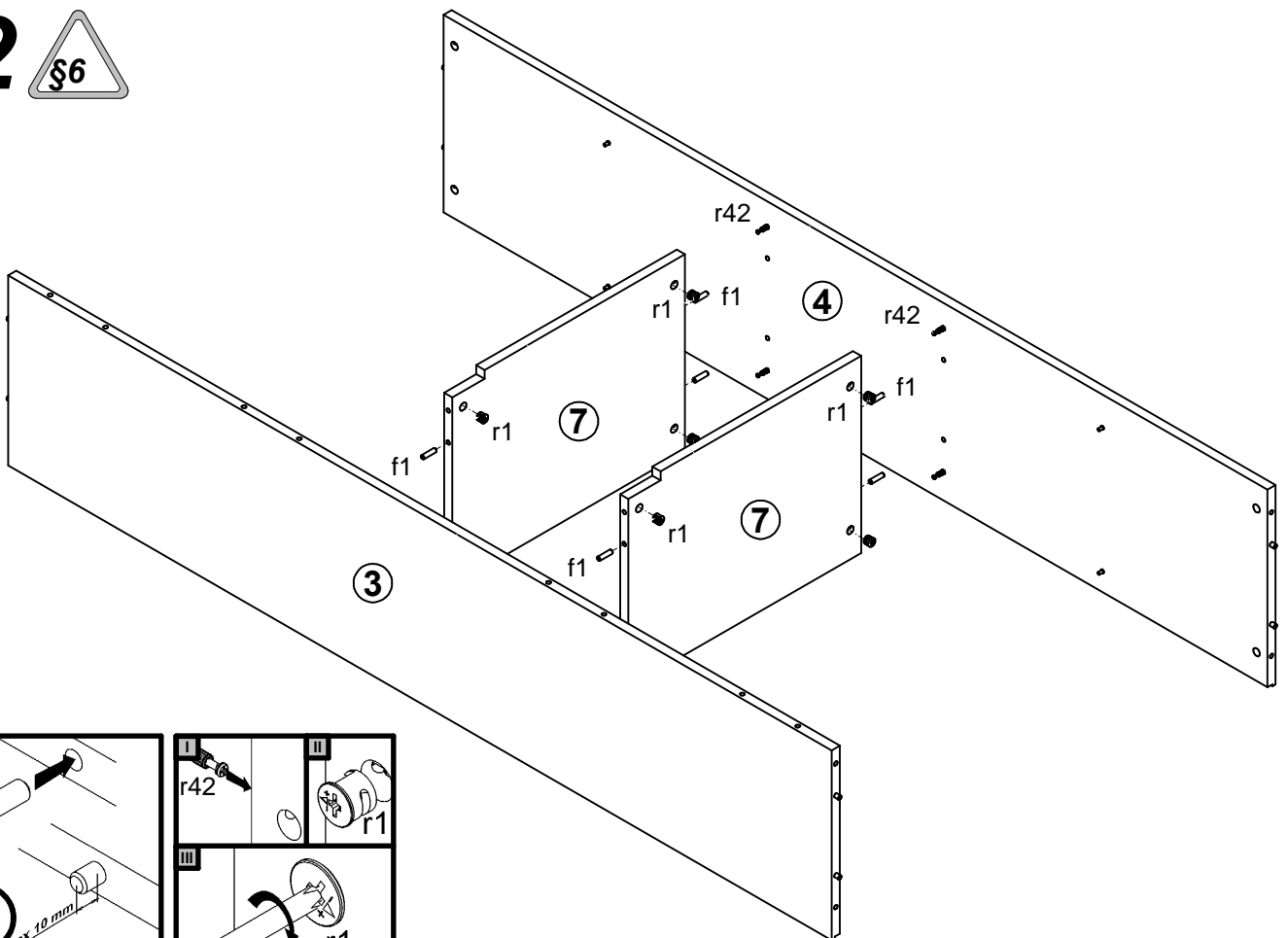

3

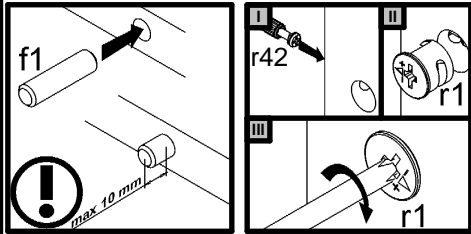
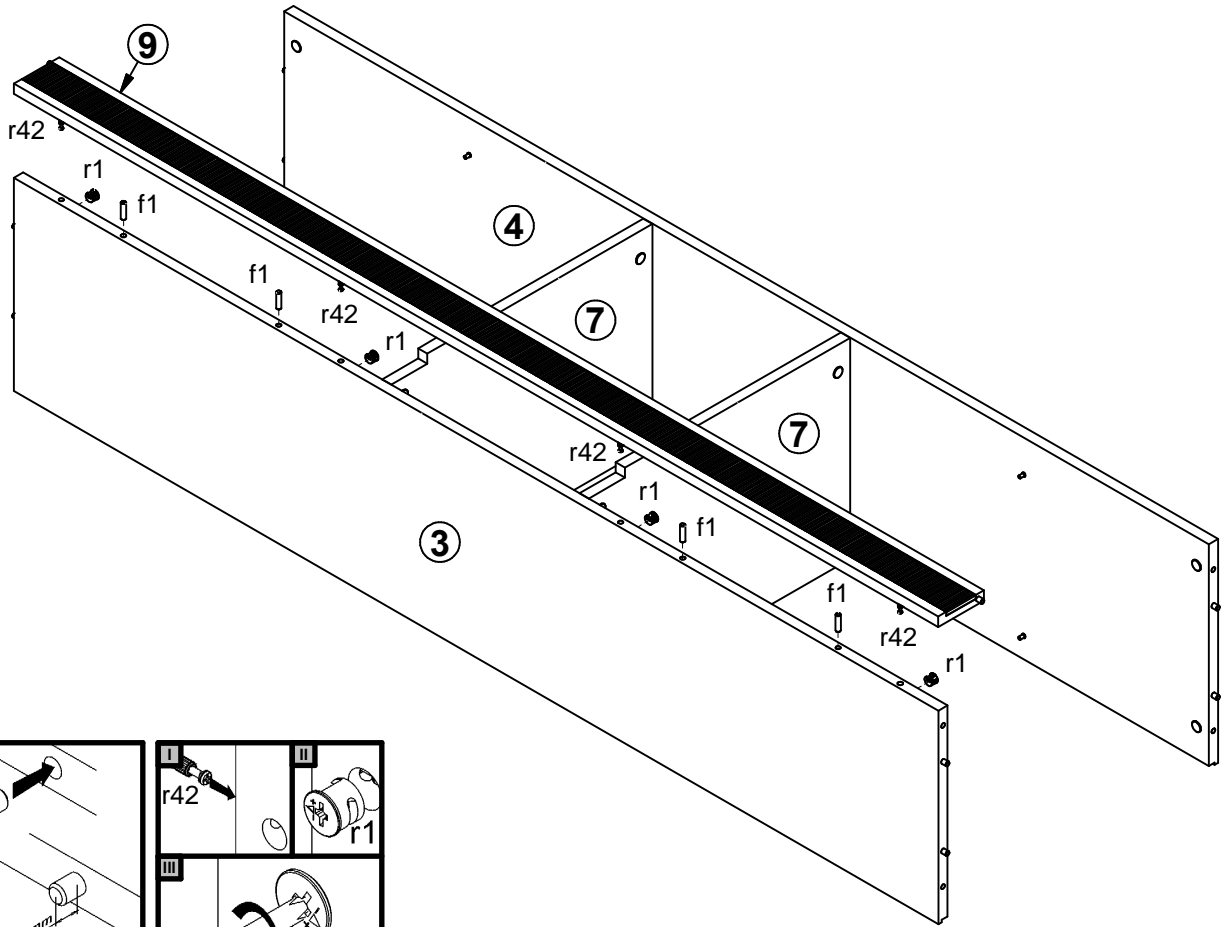

4

