

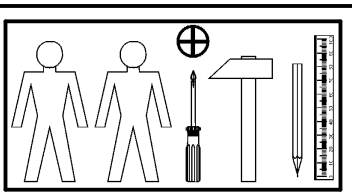

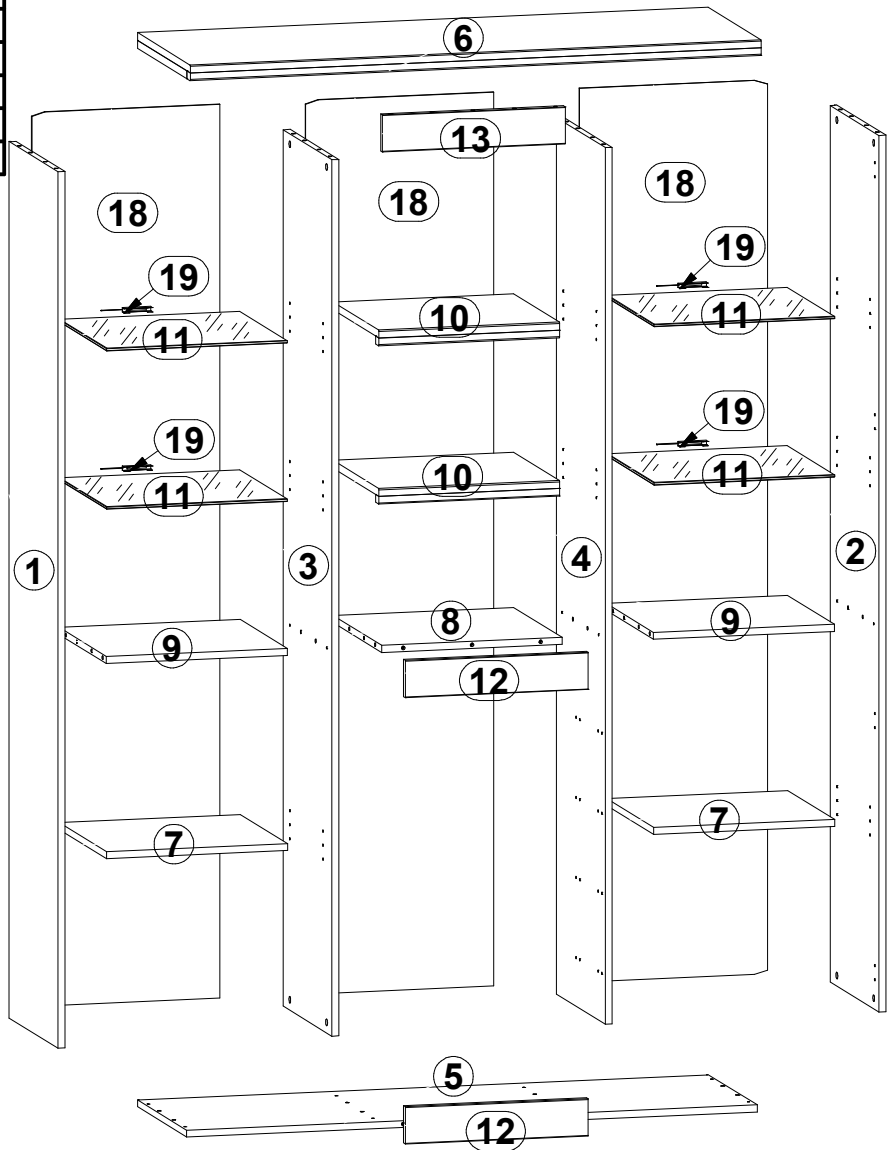

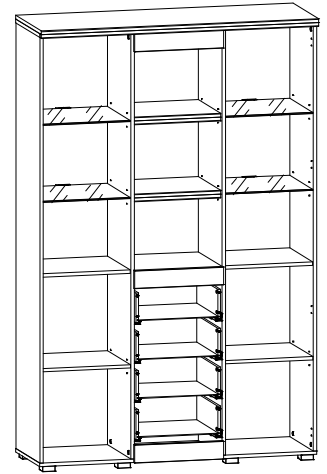











# S64-REG2W4S/21/13

A	B	C	D	
1	S64-110	2003	428	1/5
2	S64-111	2003	428	1/5
3	S64-112	2003	424	2/5
4	S64-113	2003	424	2/5
5	S64-201	1330	428	3/5
6	S64-202	1330	460	3/5
7	S64-303	422	410	2/5
8	S64-304	421	424	2/5
9	S64-305	422	410	3/5
10	S64-306	421	400	3/5
11	S64-319	421	410	4/5
12	S64-404	426	85	2/5
13	S64-405	426	85	2/5
14	S64-503	381	126	3/5
15	S64-504	400	140	3/5
16	S64-505	400	140	3/5
17	S64-902	391	406	3/5
18	S64-914	2043	438	1/5
19	qa70			3/5



16x  $\phi 5 \times 17 \text{ mm}$ <b>d1</b>	16x  $\phi 6,3 \times 15 \text{ mm}$ <b>d5</b>	32x  $\phi 6 \times 13 \text{ mm}$ <b>e3</b>	30x  $\phi 8 \times 30 \text{ mm}$ <b>f1</b>	16x  $\phi 6,5 \times 40 \text{ mm}$ <b>f25</b>	8x  <b>k55</b>	180x  <b>l1</b>	16x  $\phi 4 \times 35 \text{ mm}$ <b>p6</b>	37x  $\phi 1,5 \times 12 \text{ mm}$ #16 <b>r1</b>
16x  $\phi 12 \times 10,5 \text{ mm}$ #12 <b>r15</b>	53x  <b>r16</b>	24x  $\phi 16$ <b>s2</b>	4x  Quadro L-400 mm <b>w58\ L</b>	4x  Quadro L-400 mm <b>w58\ P</b>	1x  <b>n26\ 1</b>	1x  $\phi 3,5 \times 16 \text{ mm}$ <b>p38</b>		

1 

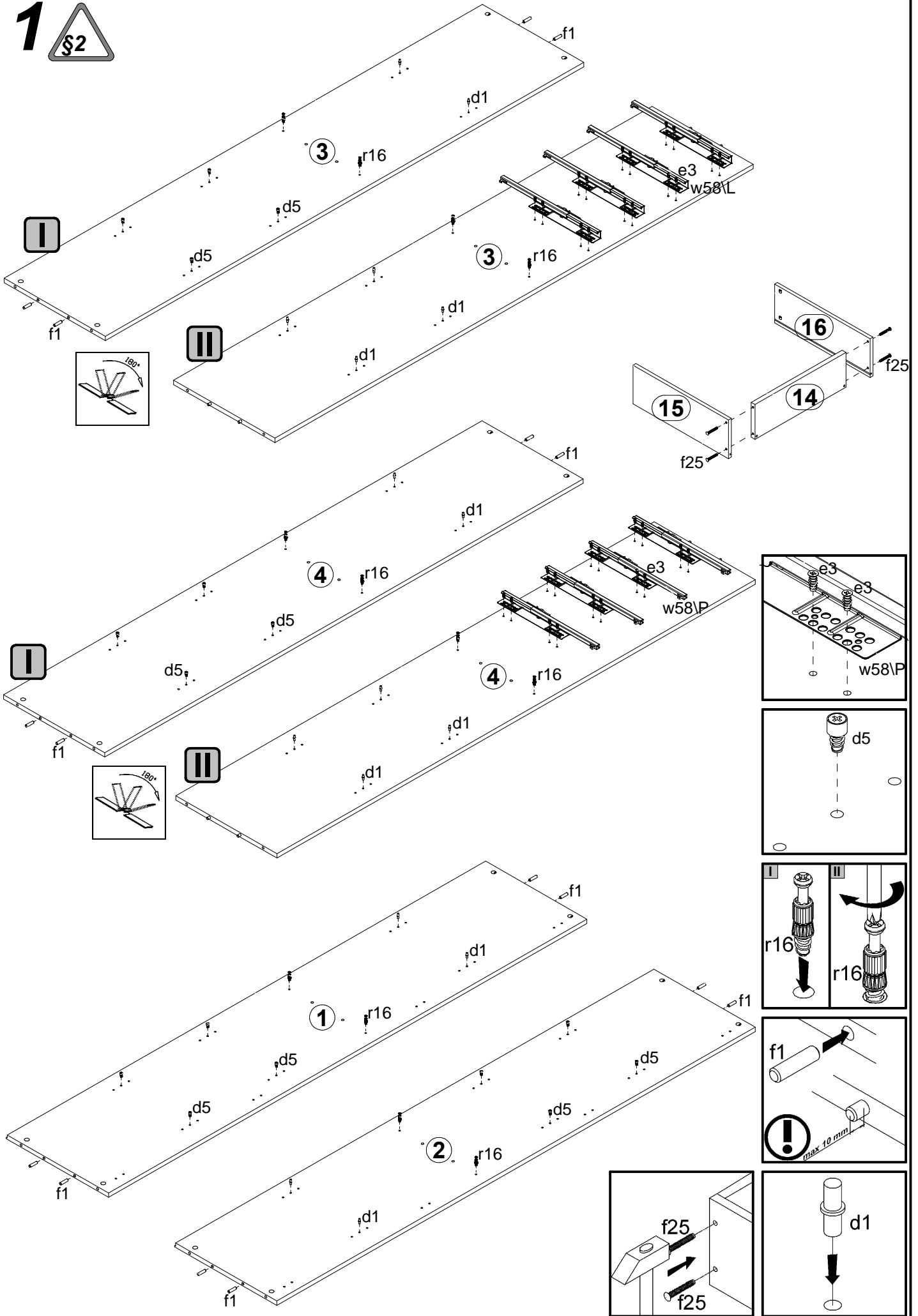

# 2

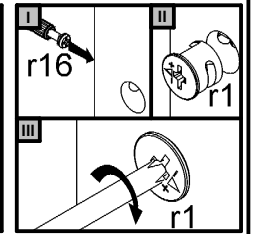
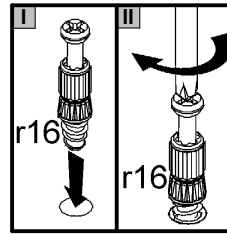
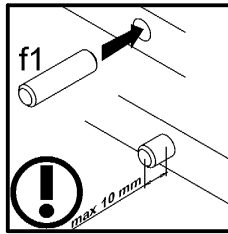
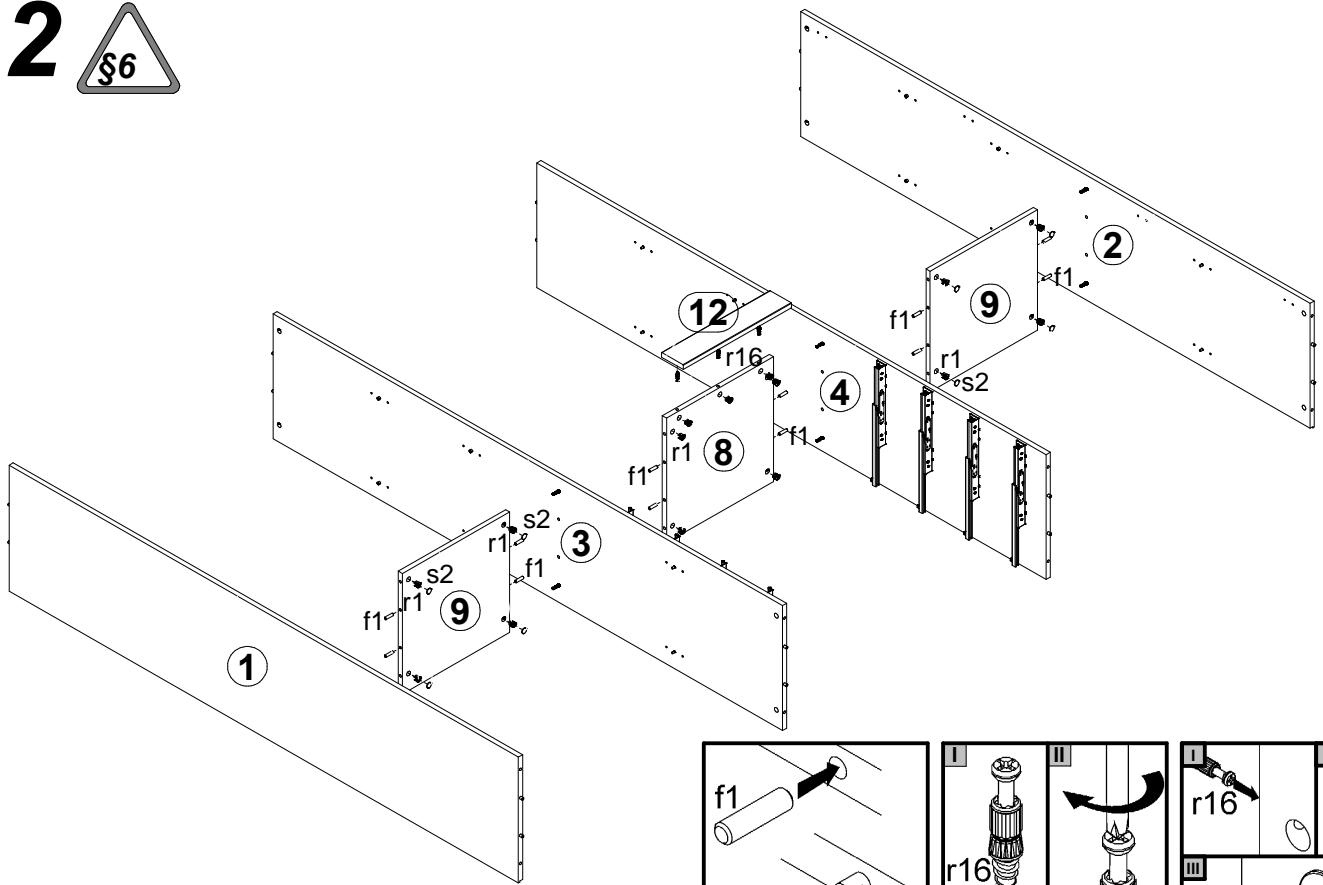

# 3

