

A	B	C	D	
1	S74-109	1833	417	1/4
2	S74-115	1833	417	1/4
3	S74-205	491	418	2/4
4	S74-211	491	418	2/4
5	S74-307	458	388	2/4
6	S74-308	458	375	2/4
7	S74-512	350	160	2/4
8	S74-513	350	160	2/4
9	S74-515	390	145	2/4
10	S74-911	400	357	2/4
11	S74-9904	1845	479	1/4

16x $\phi 5 \times 17$ mm d1	4x $\phi 6 \times 13$ mm e3	8x $\phi 6.3 \times 20$ mm e17	12x $\phi 8 \times 30$ mm f1	4x $\phi 6.5 \times 40$ mm f25	2x k65\L	2x k65\P	55x l1	4x $\phi 3.5 \times 16$ mm p38
2x $\phi 2.9 \times 24$ mm p50	1x $\phi 3 \times 12$ mm p54	12x $\phi 15 \times 12$ mm #16 r1	4x $\phi 12 \times 10.5$ mm #12 r15	16x r16	4x $\phi 16$ s2	1x 360 mm w69\1L	1x 360 mm w69\1P	1x w70\1L
1x w70\1P	1x w70\2L	1x w70\2P	1x z23\1	1x z23\2	1x z23\3	1x z24	1x n26\1	1x $\phi 3.5 \times 16$ mm p38

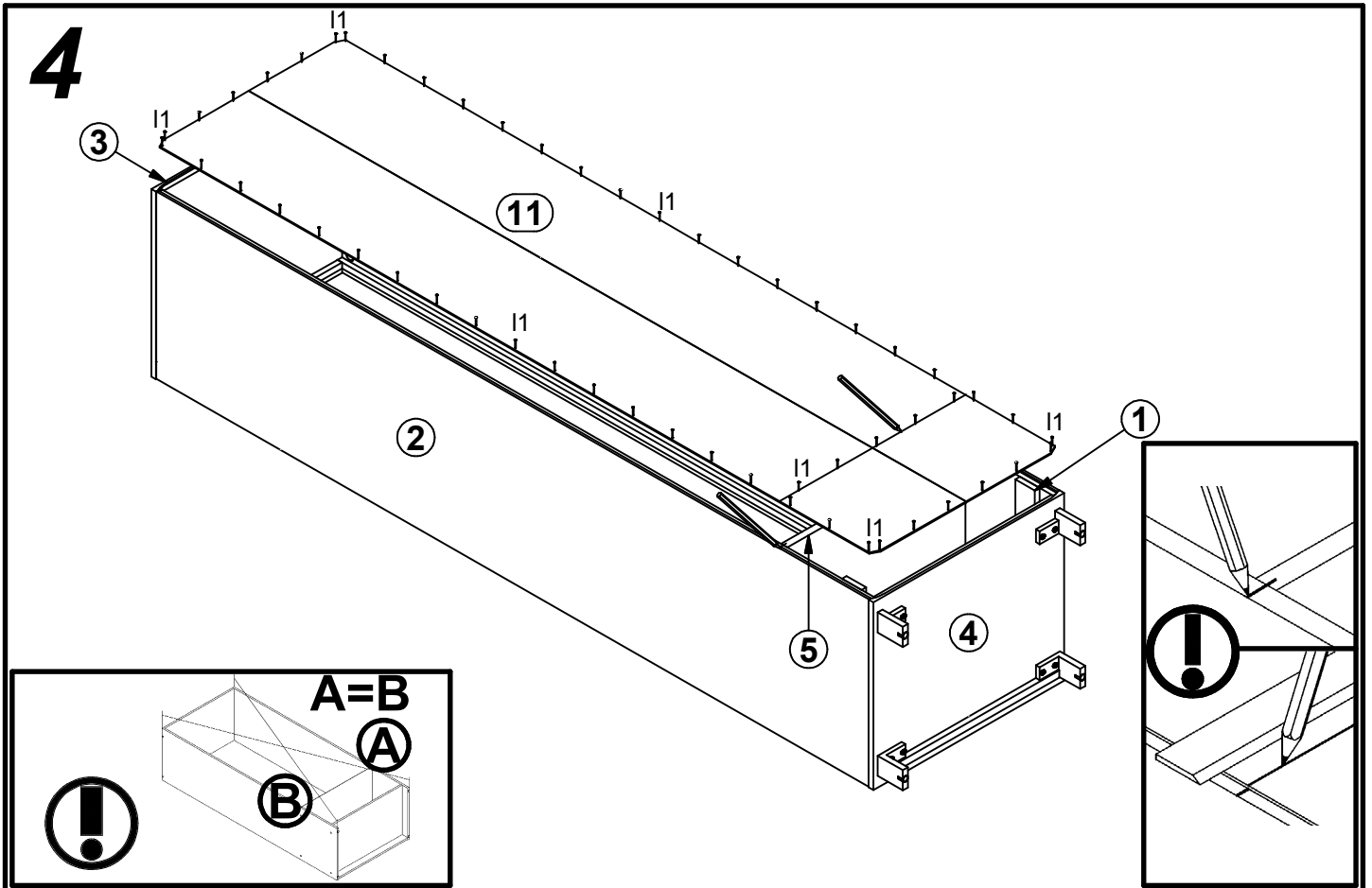

5

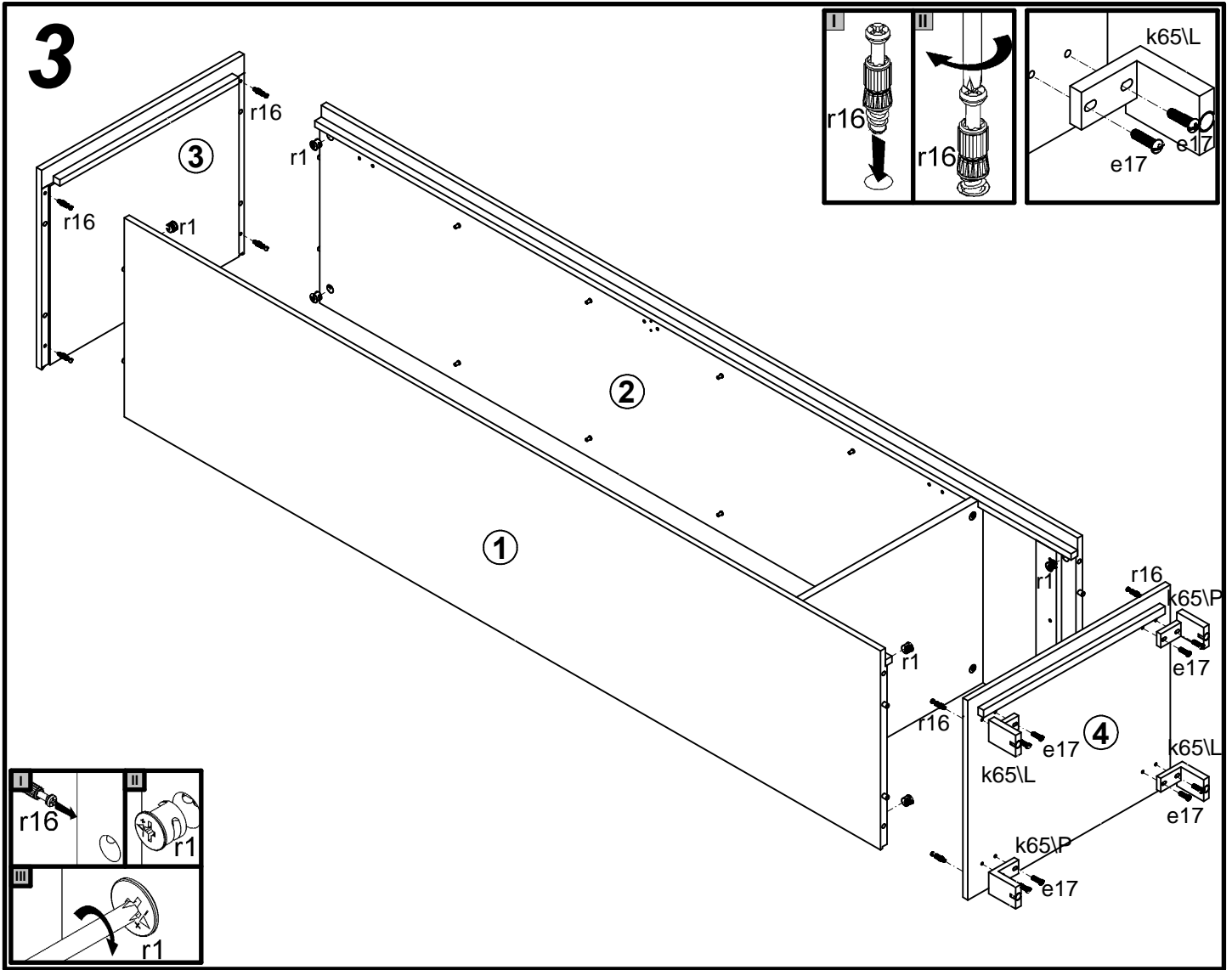
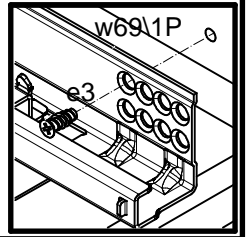
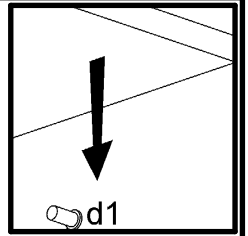
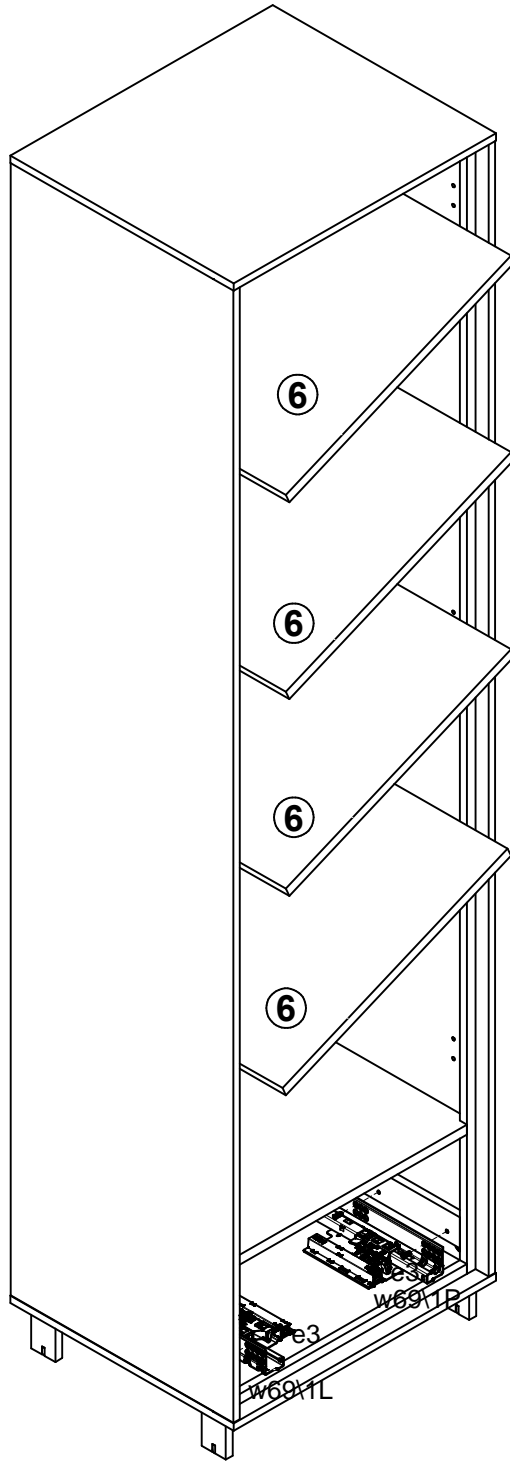

6

