

A	B	C	D
1	S301-022	660	360
2	S301-138	814	268
3	S301-139	814	268
4	S301-213	696	269
5	S301-321	665	265
6	S301-408	665	61
7	S301-413	652	138
8	S301-414	652	90
9	S301-918	762	689

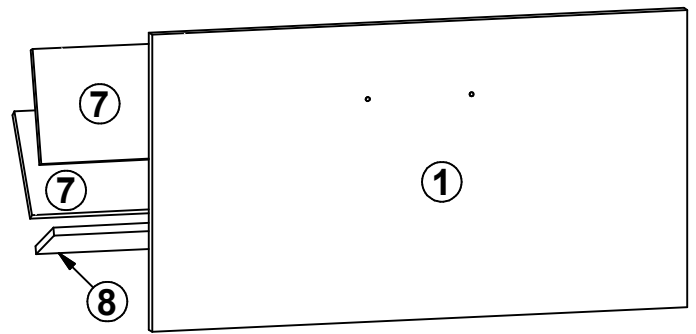

2x  c310	4x  Ø7x50 mm e1	4x  Ø6x13 mm e3	10x  Ø8x30 mm f1	2x  Ø10x50 mm f35	4x  k1	30x  l1	4x  m30\1	4x  m30\2
4x  m30\3	2x  m30\L	2x  m30\P	2x  n122	2x  Ø6x60 mm p127	12x  Ø2.5x13 mm p15	4x  Ø4x30 mm p21	12x  Ø3.5x16 mm p38	4x  Ø4x25 mm p87
4x  Ø15x12 mm #16 r1	4x  r42	2x  s1	4x  Ø16 s2	1x  z1				

# 1

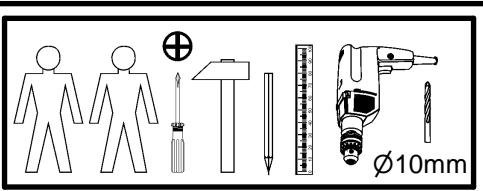
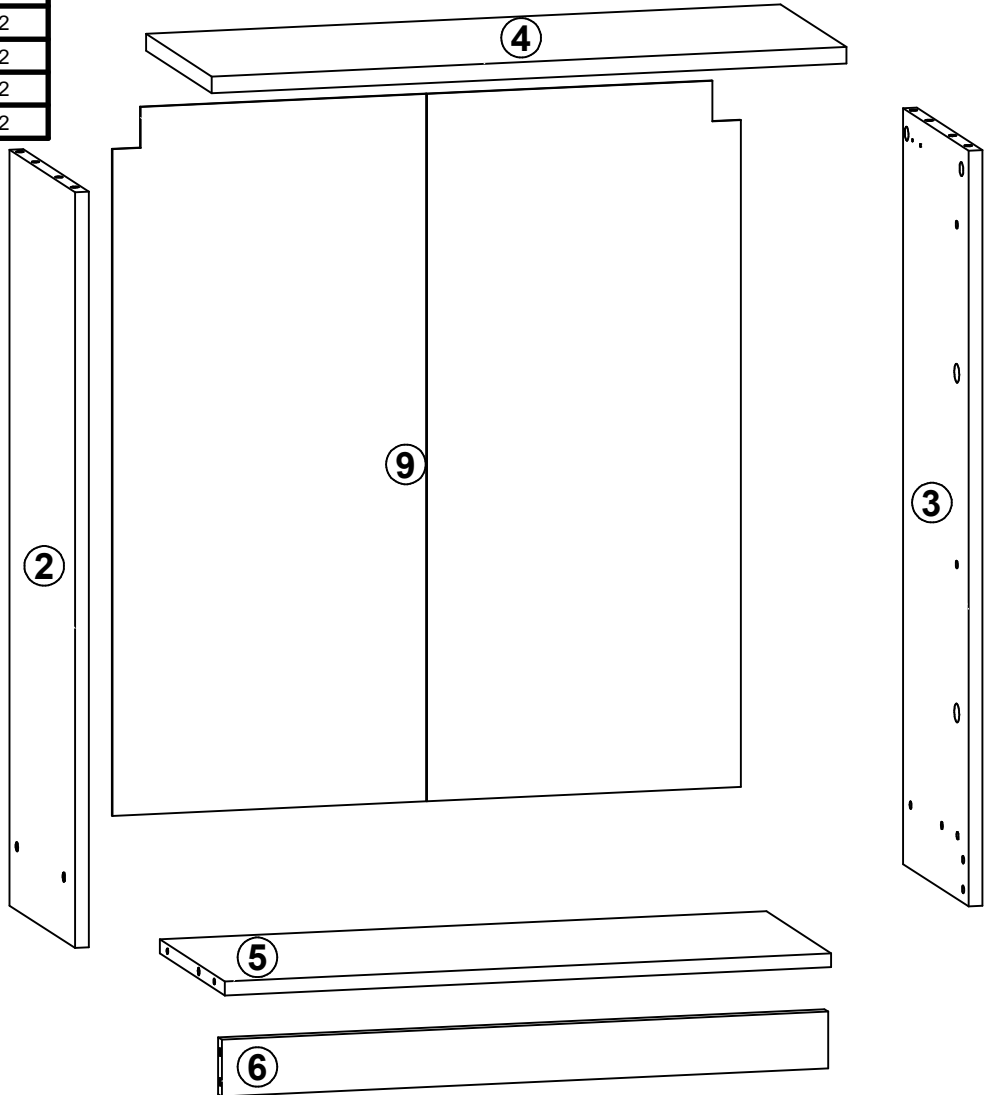
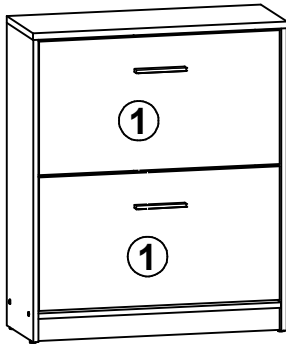
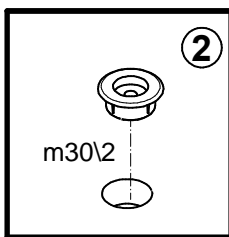
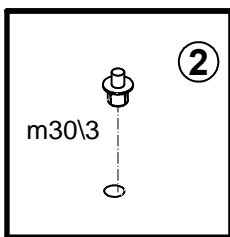
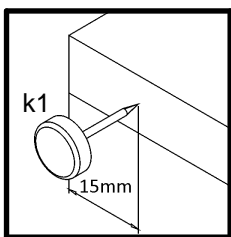
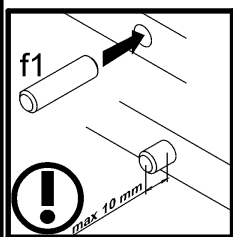
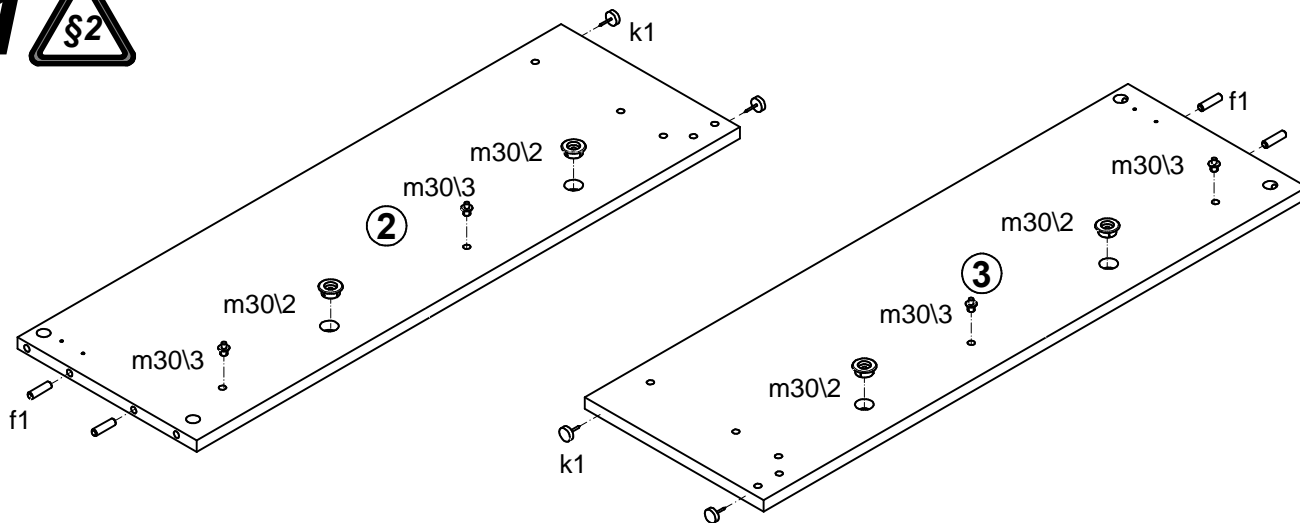

# 2

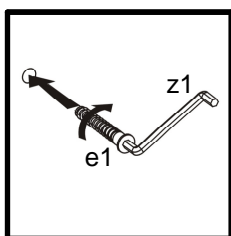
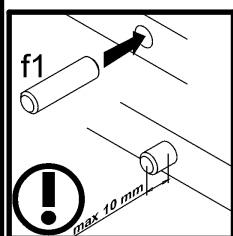
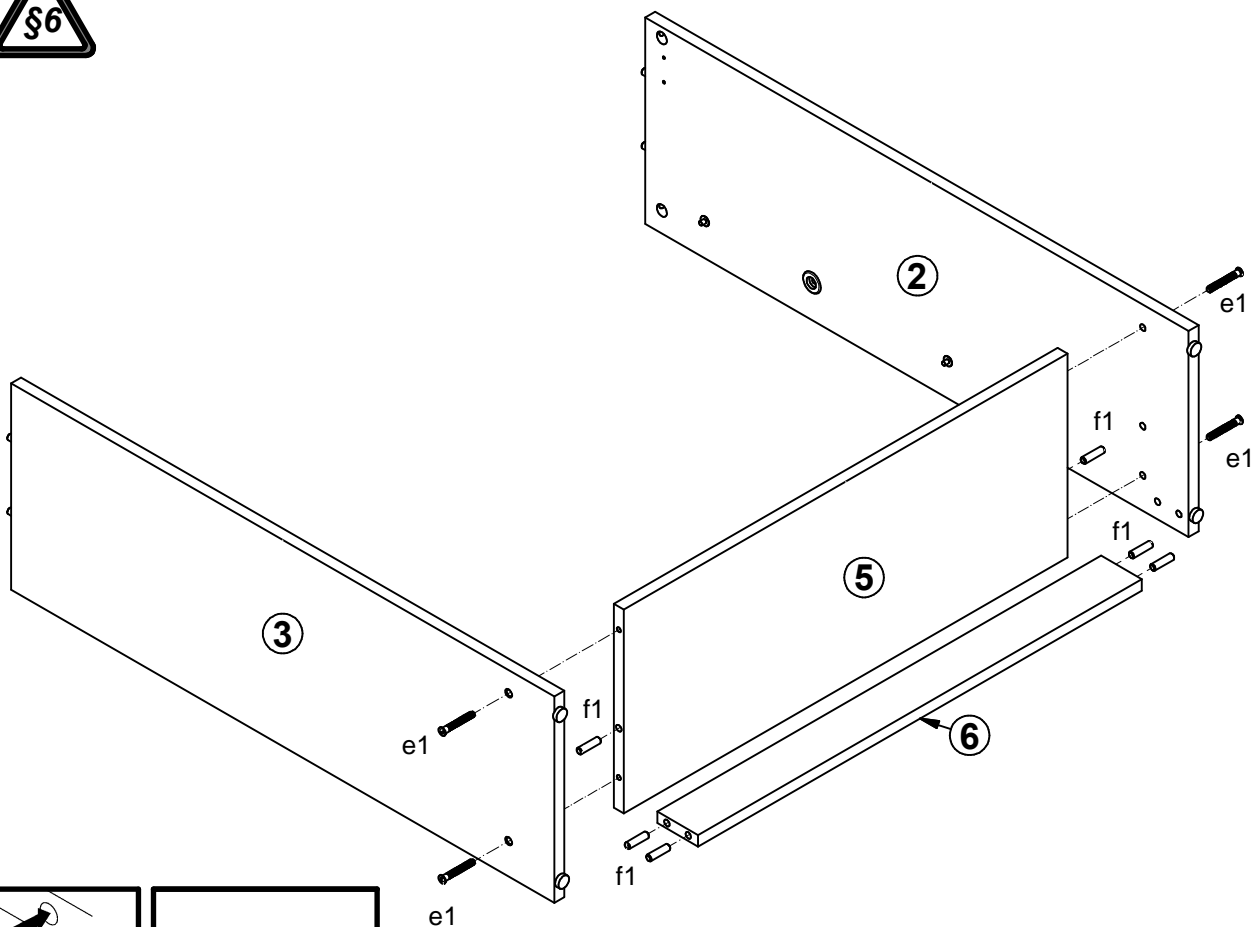

# 3

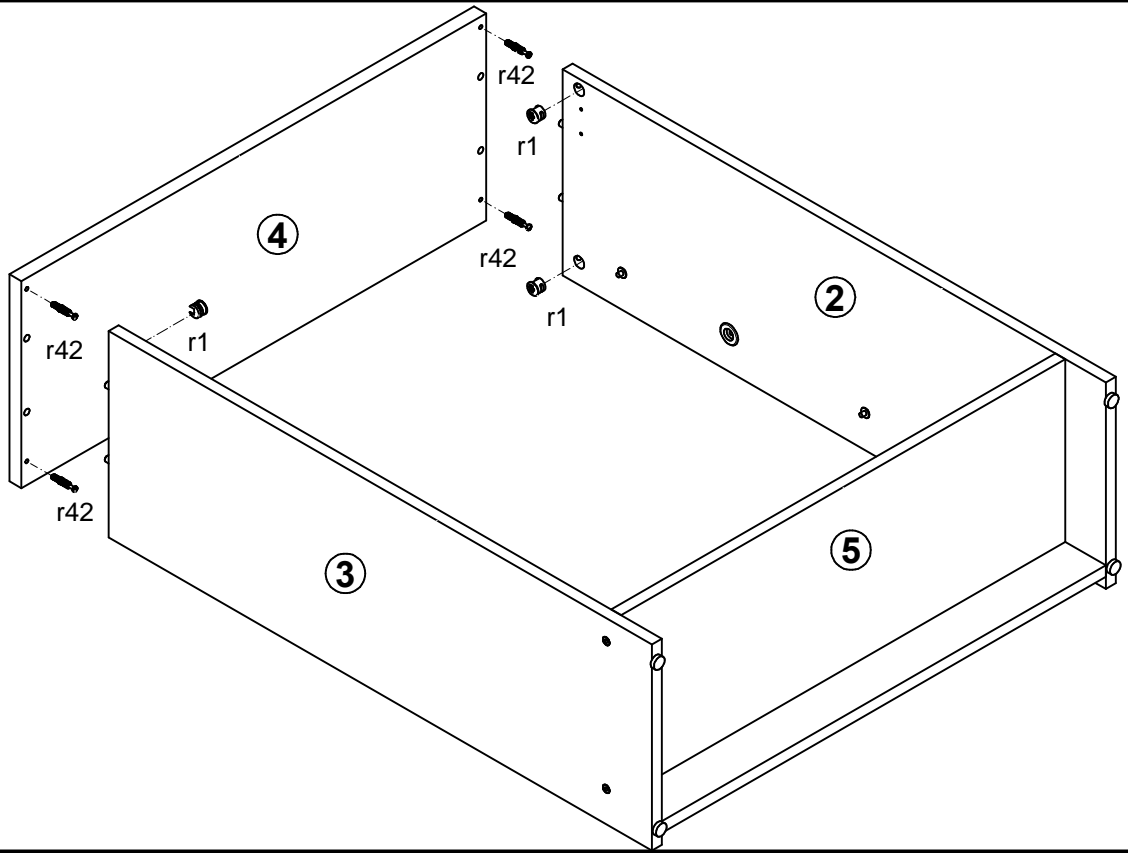
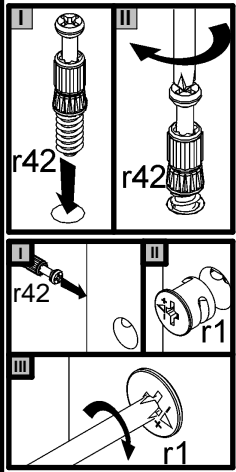

# 4

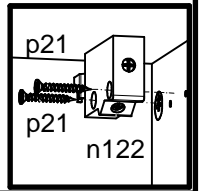
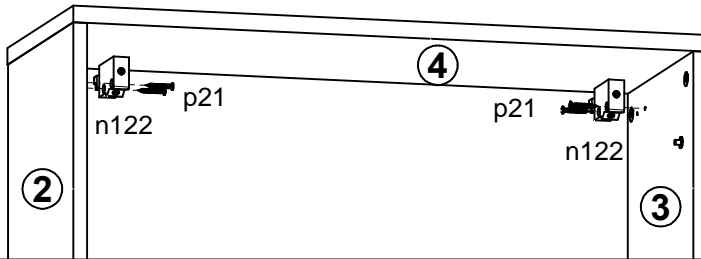

# 5

