

S66-RTV2S/4/15-FRN 10 007 30

A	B	C	D
1	S66-008	446	176
2	S66-009	446	176

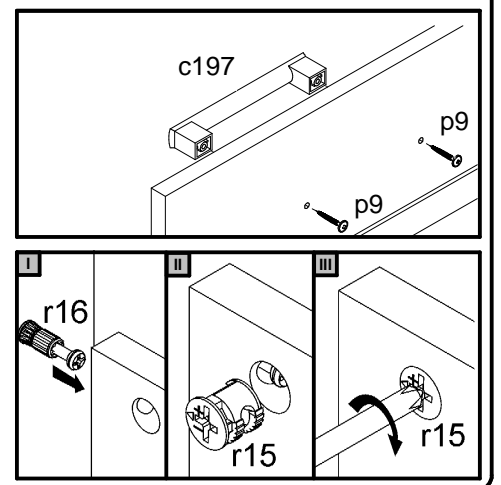

2

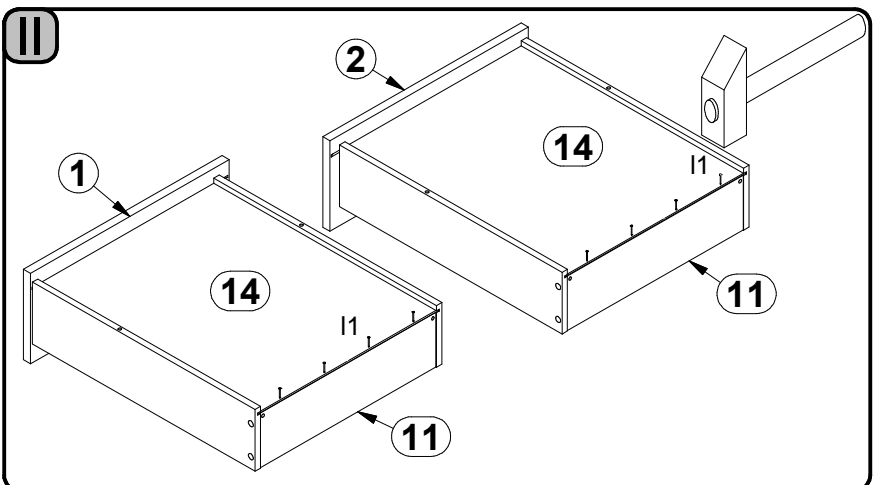
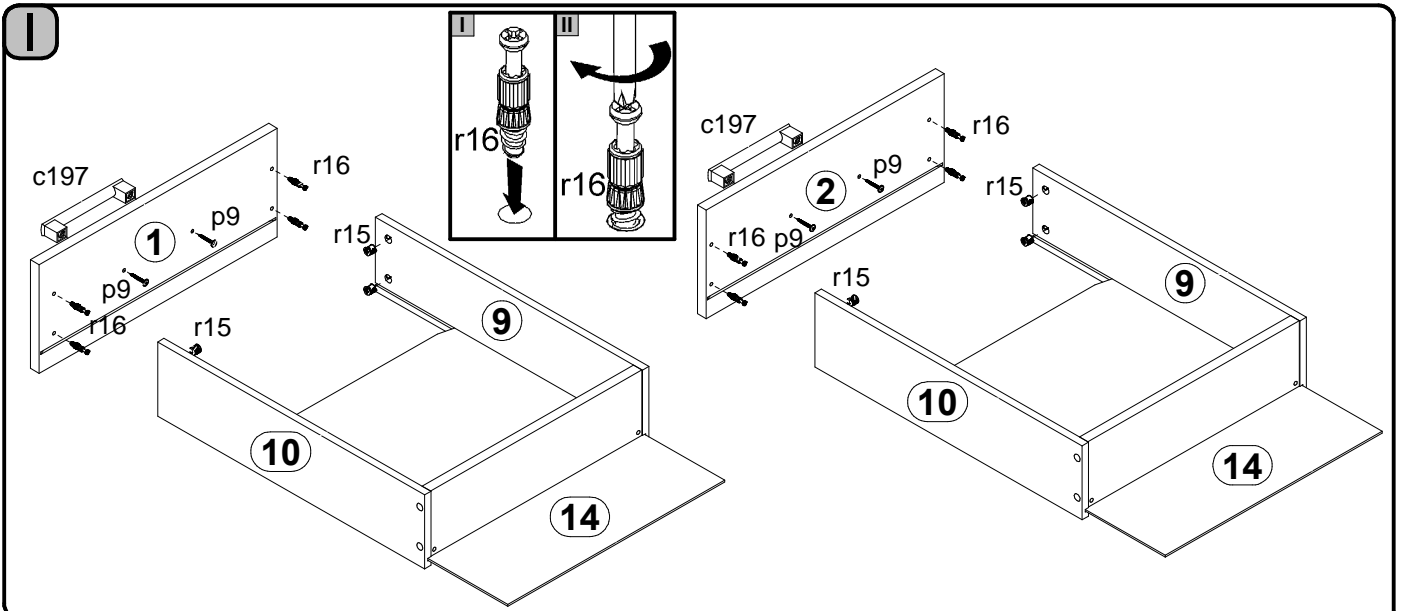
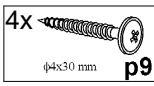
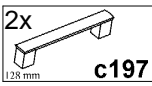
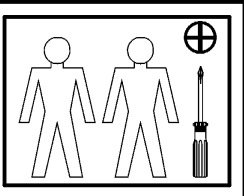
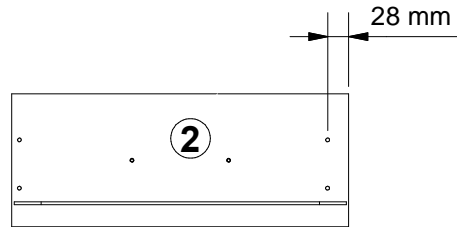
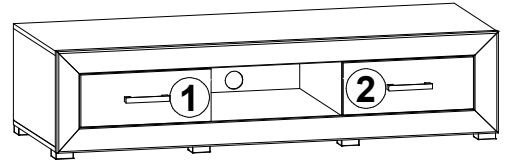
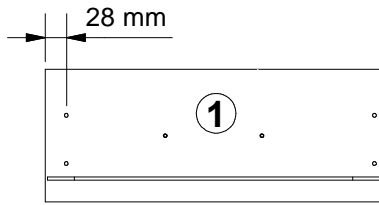