

Podczas montażu
postępowac
zgodnie z instrukcją.

While assembling
follow
the instruction.

Montage laut
der Aufbauanleitung
durchführen.

3 kp 1/4

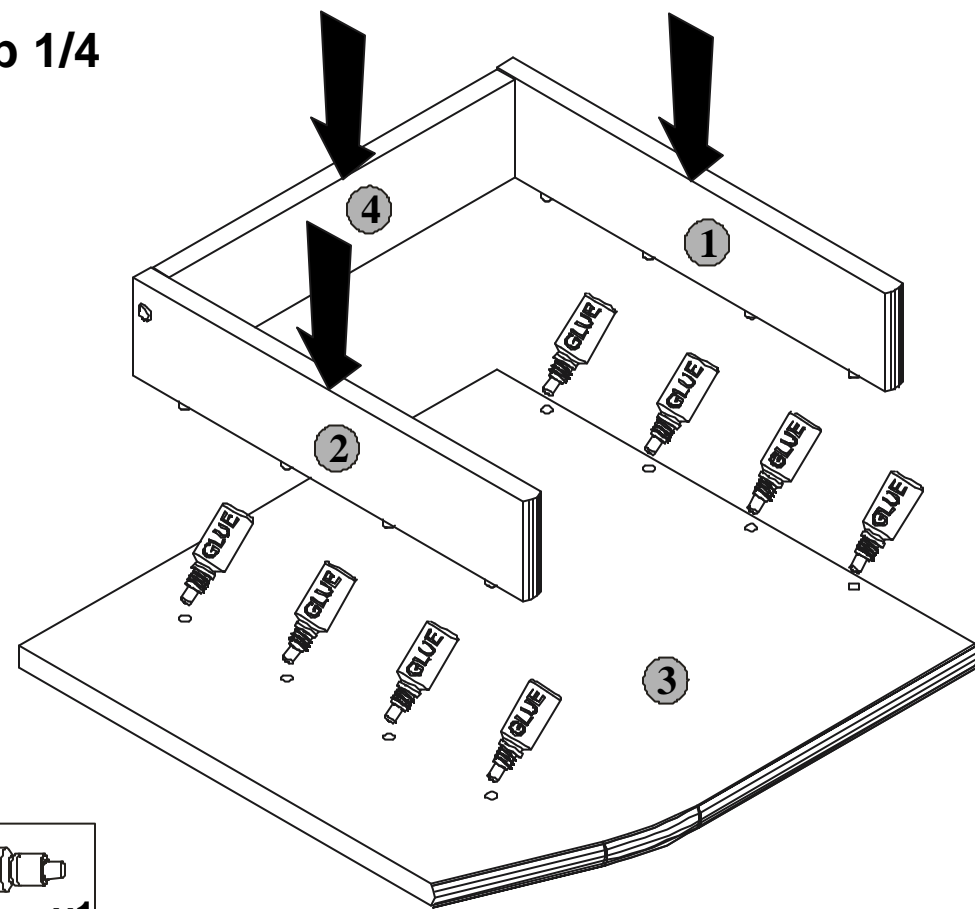

**INSTRUKCJA MONTAZU
FITTING-UP INSTRUCTION
AUFBAUANLEITUNG**

POP System

kp 1/4

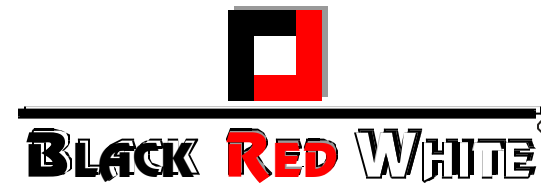

Producent:
BLACKREDWHITES.A.
UL. KRZESZOWSKA 63
23-400 BILGORAJ

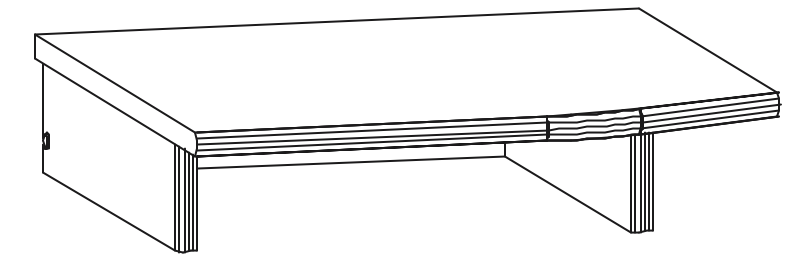

45/10/45 /cm/

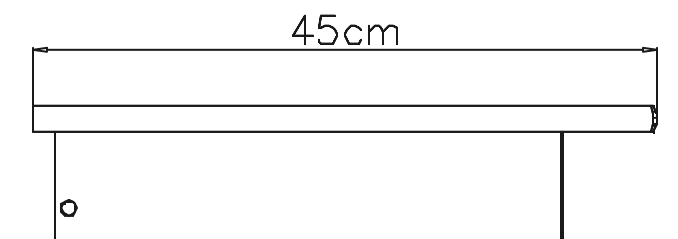
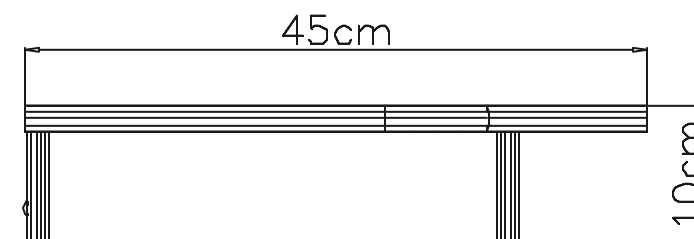



POP System

kp 1/4

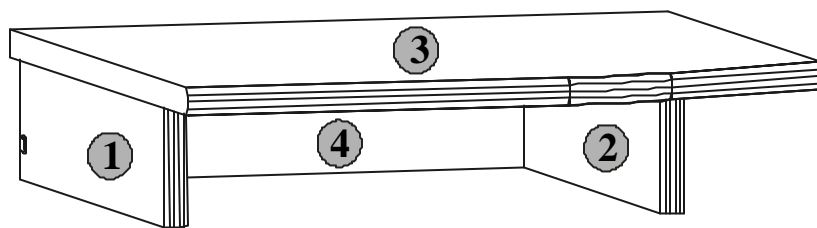

Paczki:/Packages:/Paketen:
 Akcesoria/Accessories /Zubehör
 Korpus 1/Body 1/Möbelkorps 1

Symbolelementu Element symbol Elementeszeichen	Wymiary Measurements Ausmaß	Kod Code Kode
1	336x80	SK1-177
2	336x80	SK1-178
3	400x400	SK1-219
4	274x80	SK1-423

Korpus1/Body1/Möbelkorps1

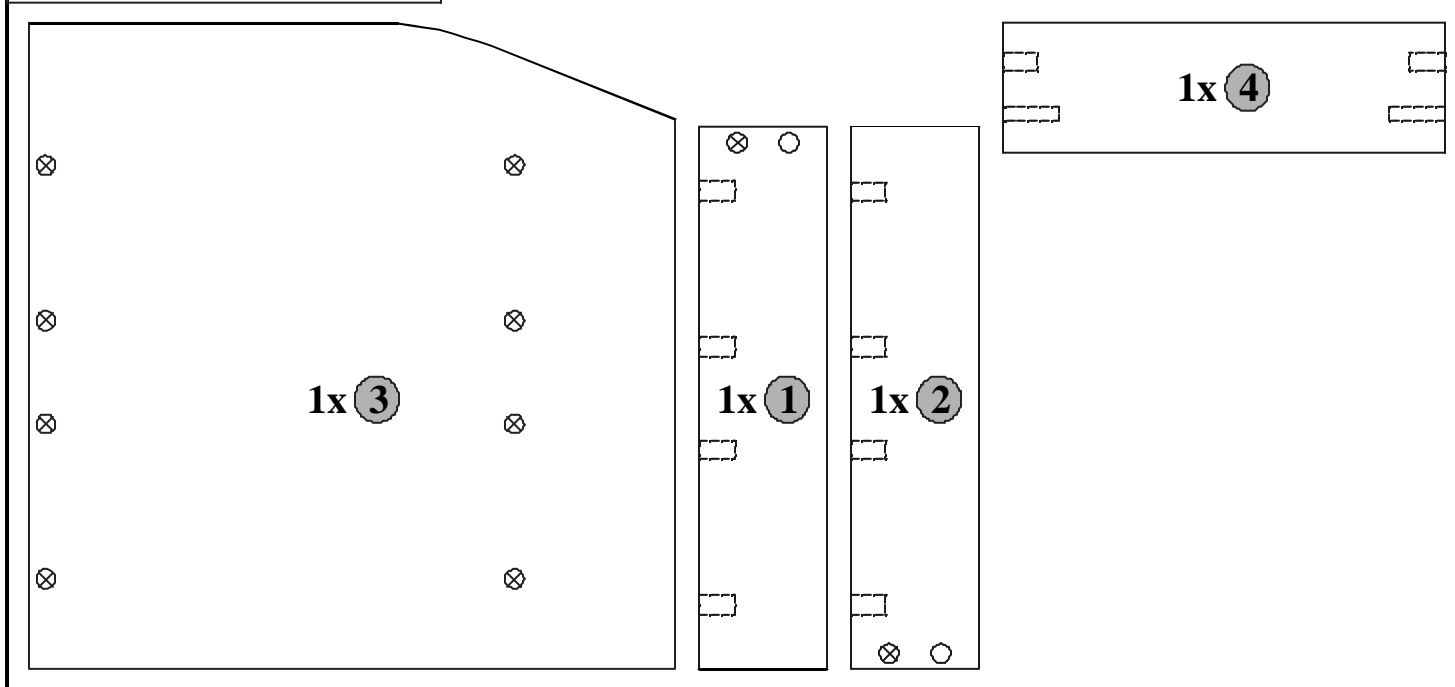

Akcesoria/Accessories/Zubehör

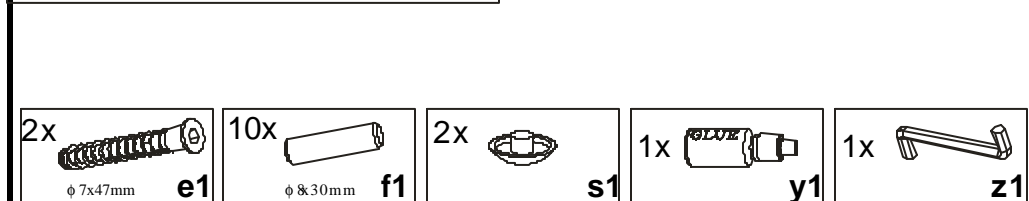

Domontazupotrzebnesa:
 Youneedforfitting-up:
 ZurMontagewerdenSiebrauchen:

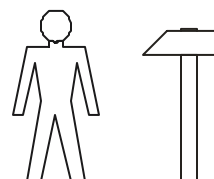

Podczasmontazu
 postepowac
 zgodniezinstrukcja.

While assembling
 follow
 theinstruction.

Montagelaut
 derAufbauanleitung
 durchführen.

1 kp 1/4

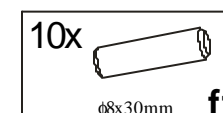
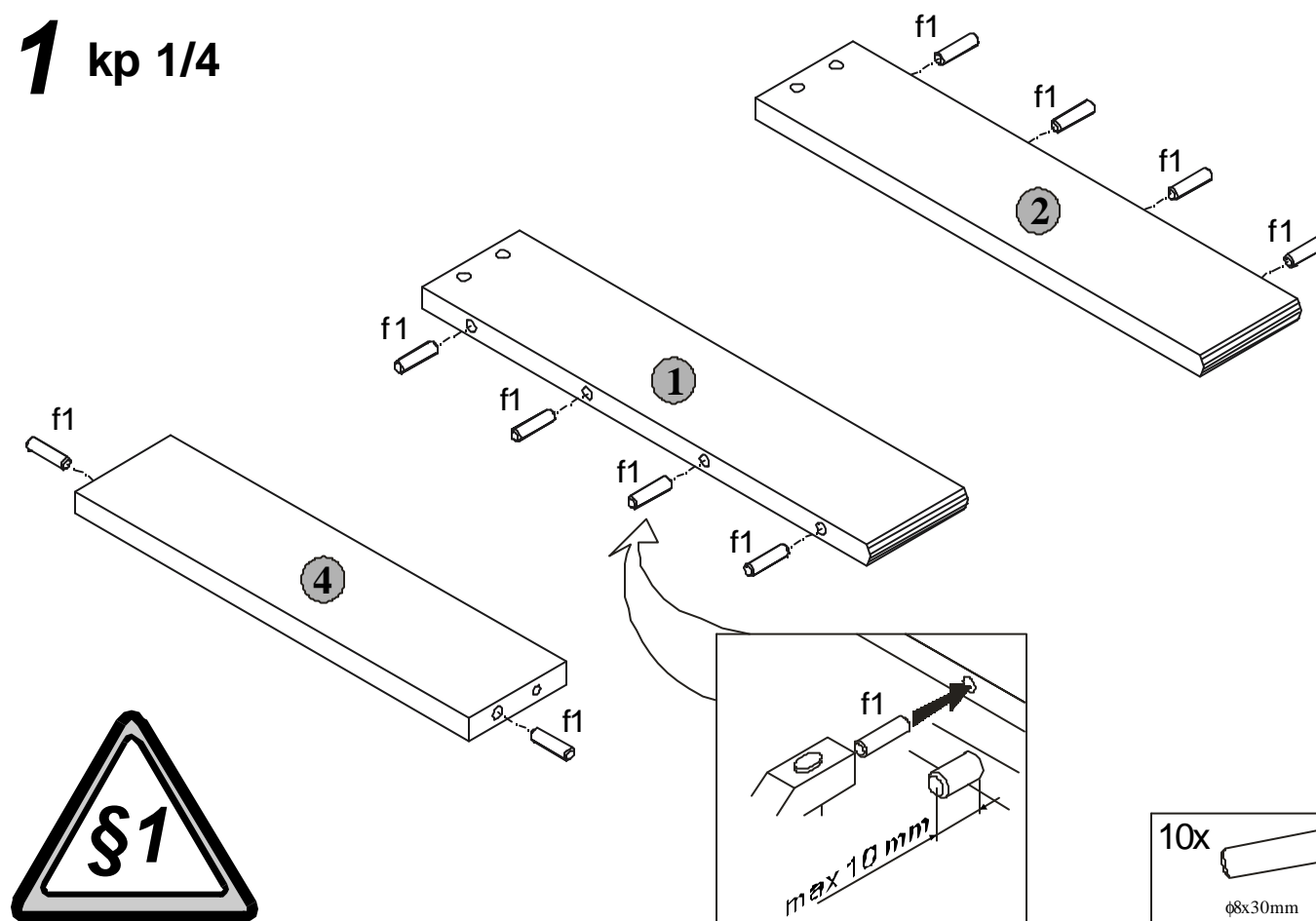

2 kp 1/4

