

RINGO

S61-REG1D/5/19

| A | B | C | D | |
|---|---------|------|-----|-----|
| 1 | S61-007 | 1780 | 496 | 3/3 |
| 2 | S61-115 | 1748 | 370 | 1/3 |
| 3 | S61-116 | 1748 | 370 | 1/3 |
| 4 | S61-201 | 500 | 370 | 1/3 |
| 5 | S61-202 | 500 | 370 | 1/3 |
| 6 | S61-301 | 463 | 370 | 1/3 |
| 7 | S61-302 | 461 | 369 | 1/3 |
| 8 | S61-901 | 1778 | 493 | 1/3 |

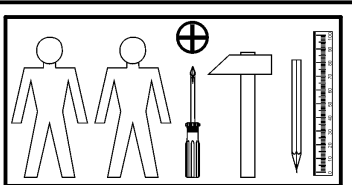
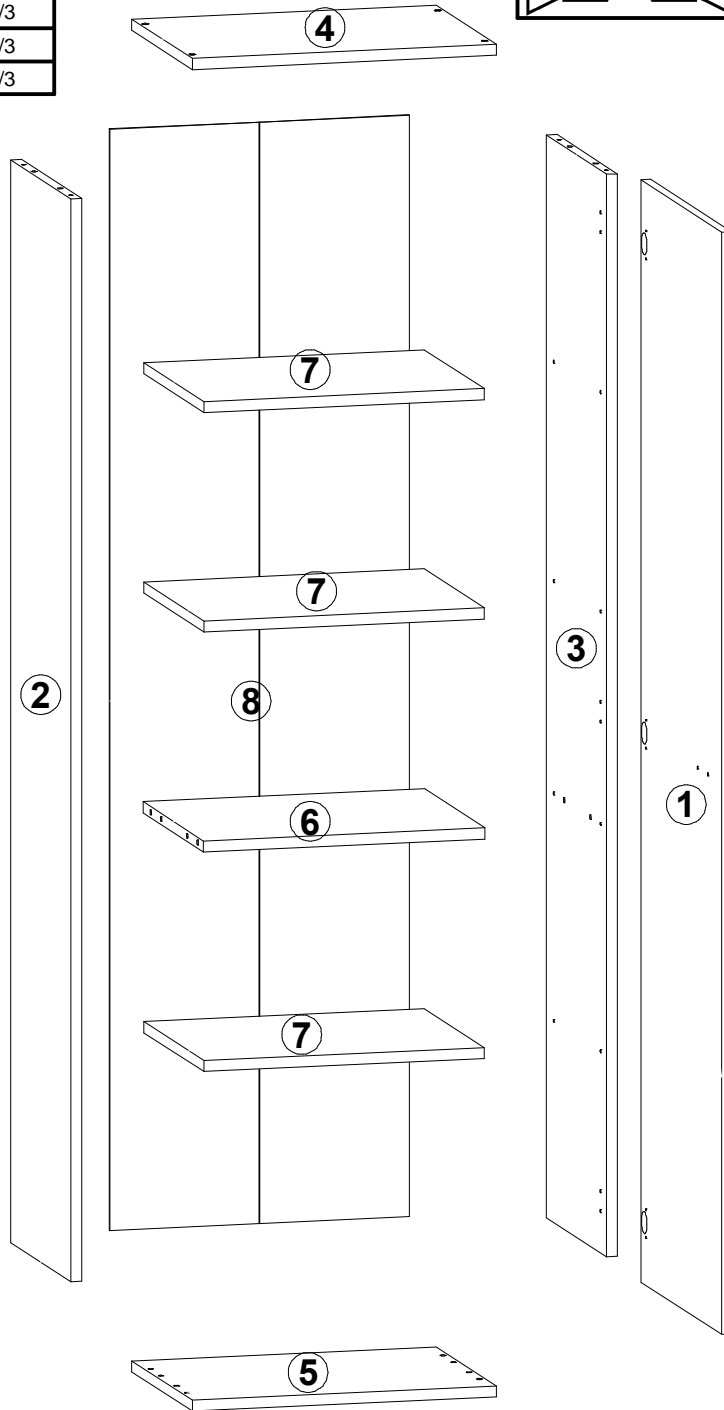
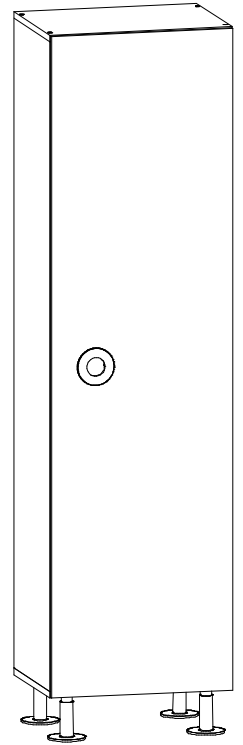
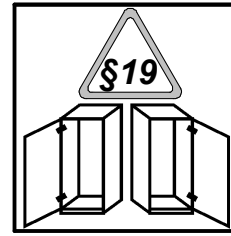

| | | | | | | | | |
|-------------|-----------|-------------------------|-----------------------|---------------------------|------------------------|-------------------------|-----------------------|-------------------------|
| 3x a44 | 3x b33 | 1x c210 | 12x d1 φ5x17 mm | 8x e1 φ7x50 mm | 6x e2 φ6,3x13 mm | 16x e7 φ6,3x16 mm | 12x f1 φ8x30 mm | 4x k57/1 |
| 4x k57/2 | 60x l1 | 6x p51 φ3,5x15 mm | 2x p90 φ4x28 mm | 4x r1 φ1,5x12mm #16 | 4x r16 | 1x z1 | 1x n26/1 | 1x p38 φ3,5x16 mm |

1 §2 §6

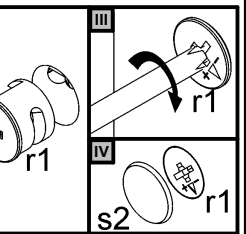
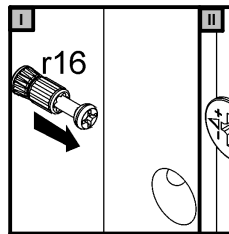
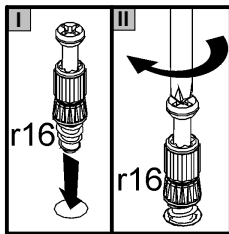
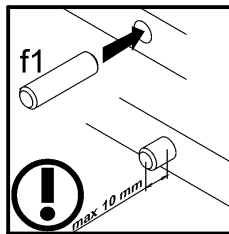
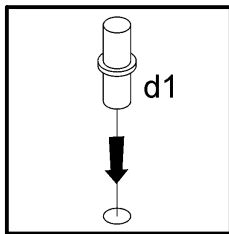
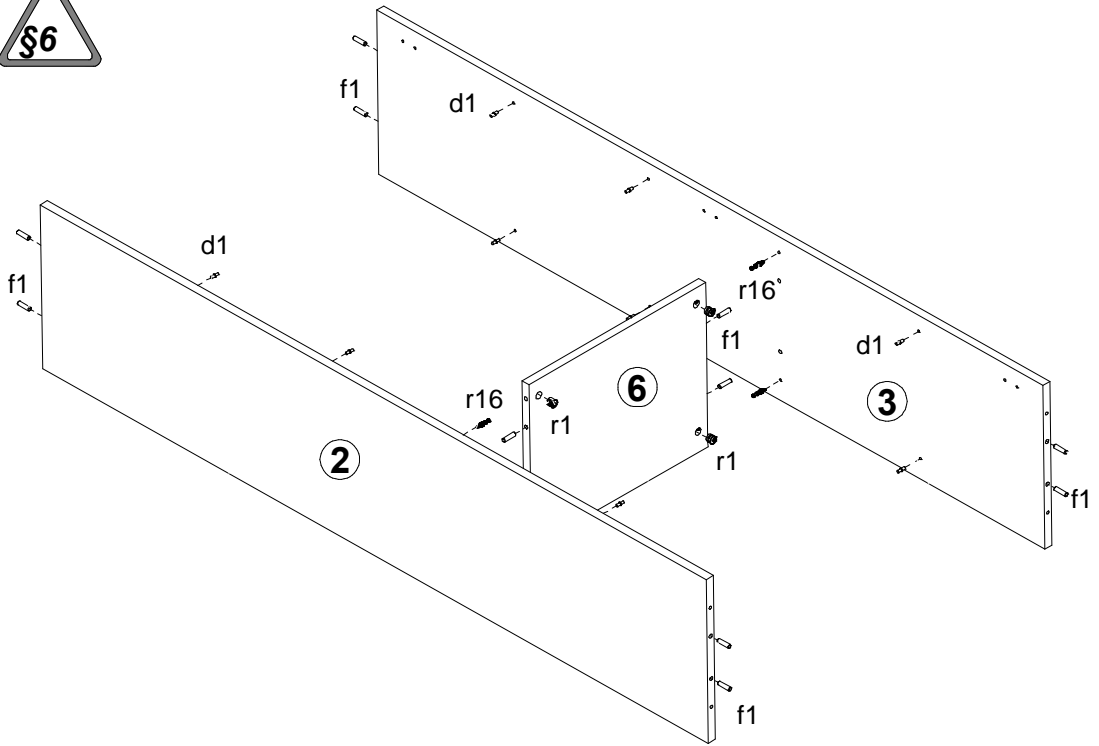

2

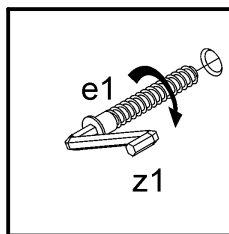
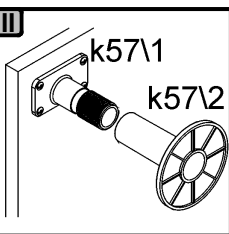
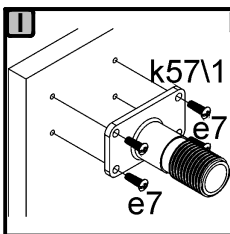
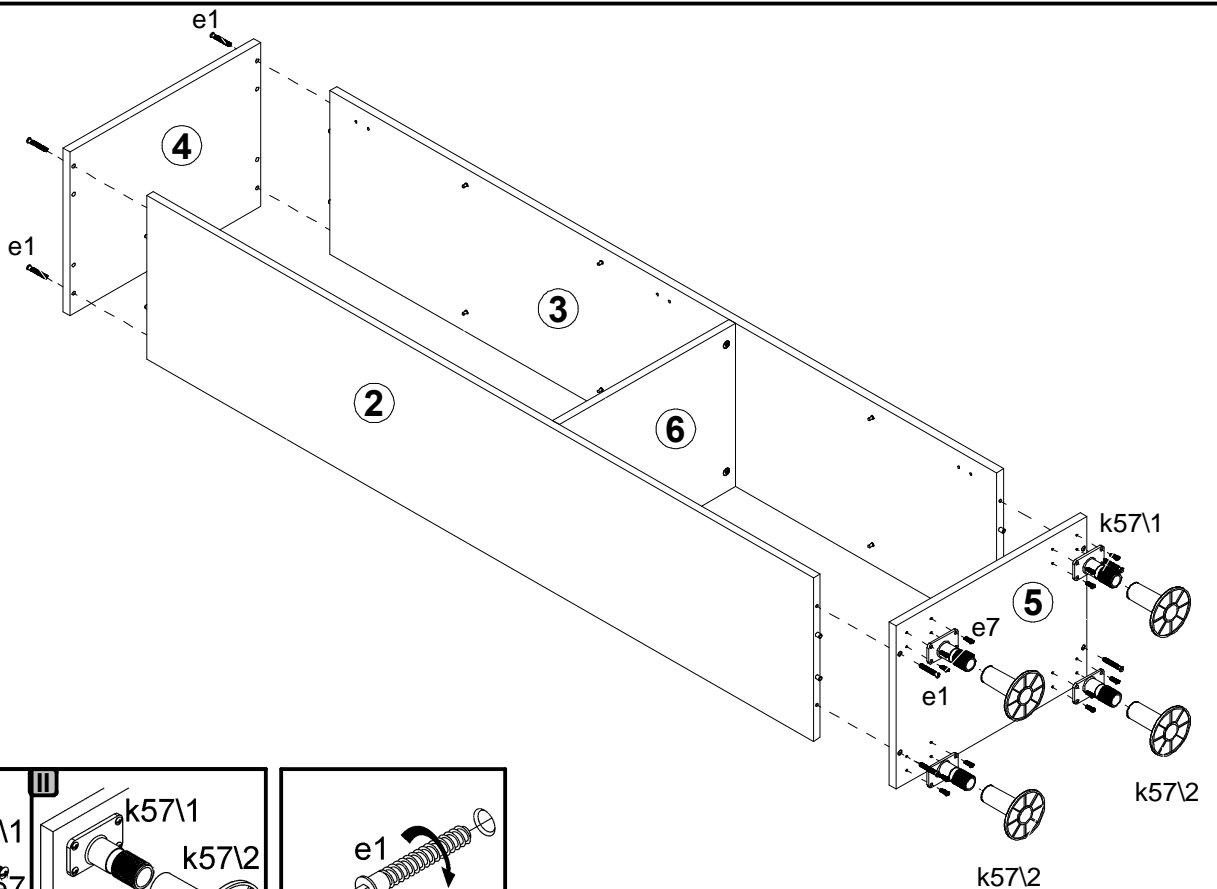

3

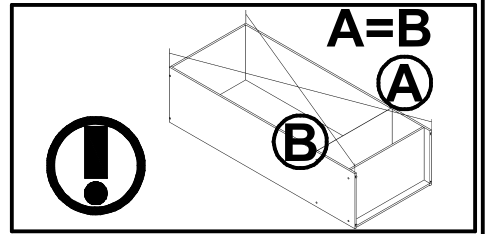
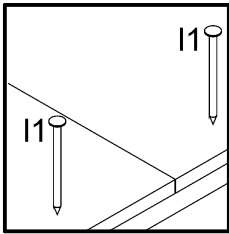
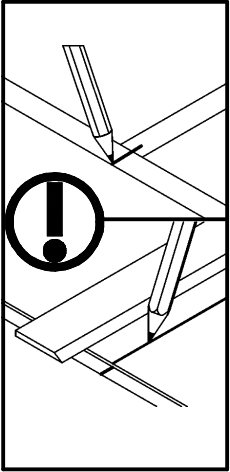
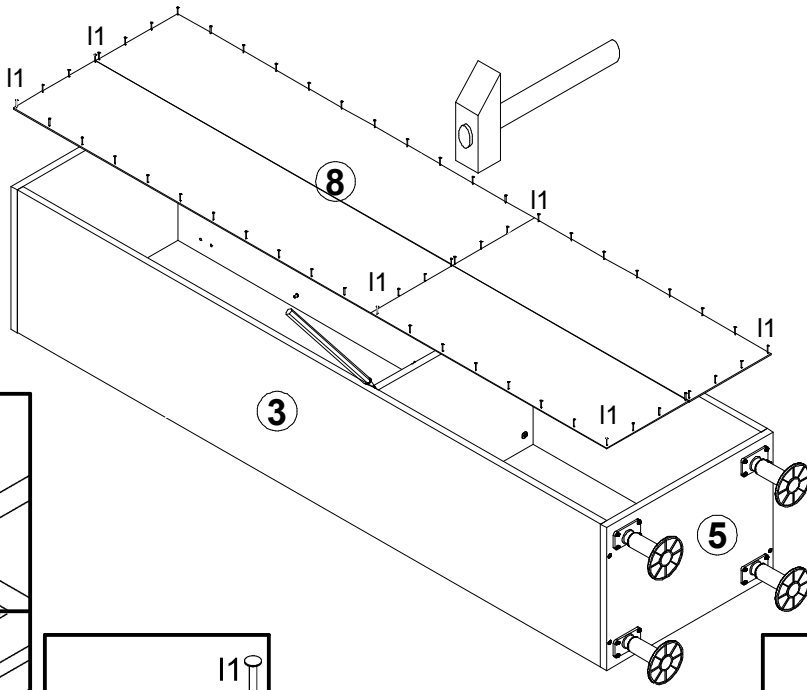

4

