

# RINGO

S61-REG/5/19

A	B	C		D
1	S61-113	1881	306	1/2
2	S61-114	1881	306	1/2
3	S61-211	500	306	2/2
4	S61-305	463	306	2/2
5	S61-306	461	305	2/2
6	S61-401	463	114	2/2
7	S61-901	1778	493	1/2

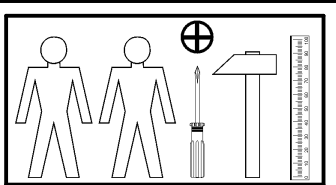
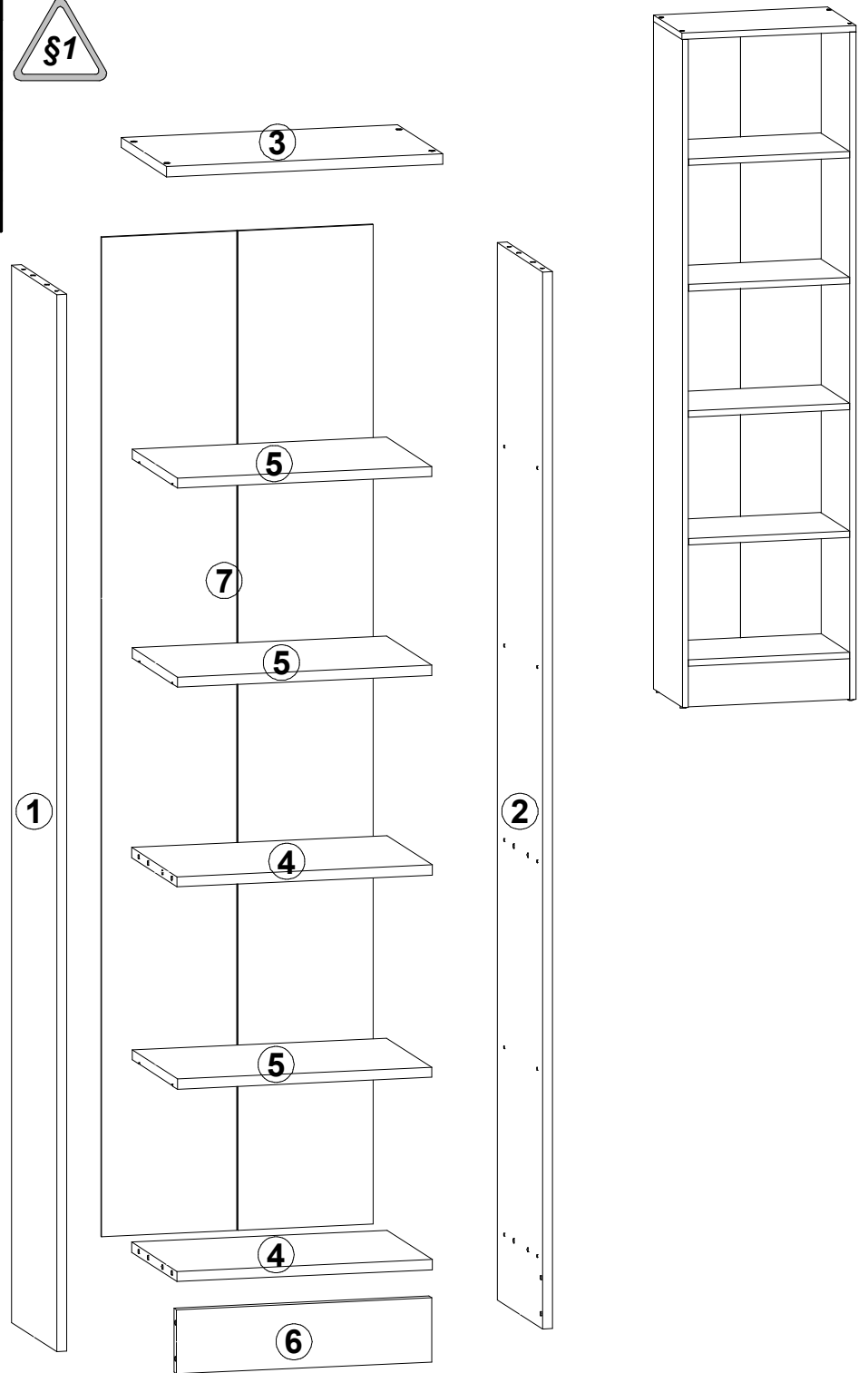

12x φ5x17 mm d1	4x φ7x50 mm e1	16x φ8x30 mm f1	4x k1	60x l1	8x φ15x12mm #16 r1	8x r16	1x z1	1x n26\1
1x φ3,5x16 mm p38								

**1** §2 §6

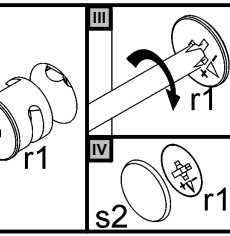
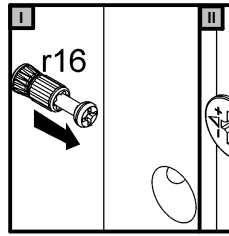
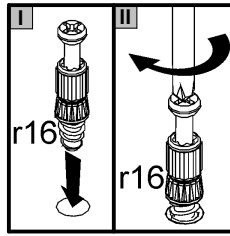
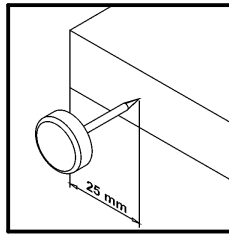
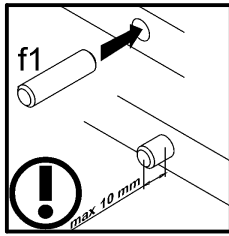
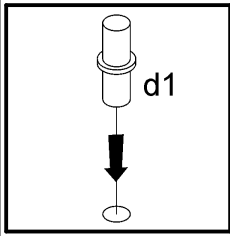
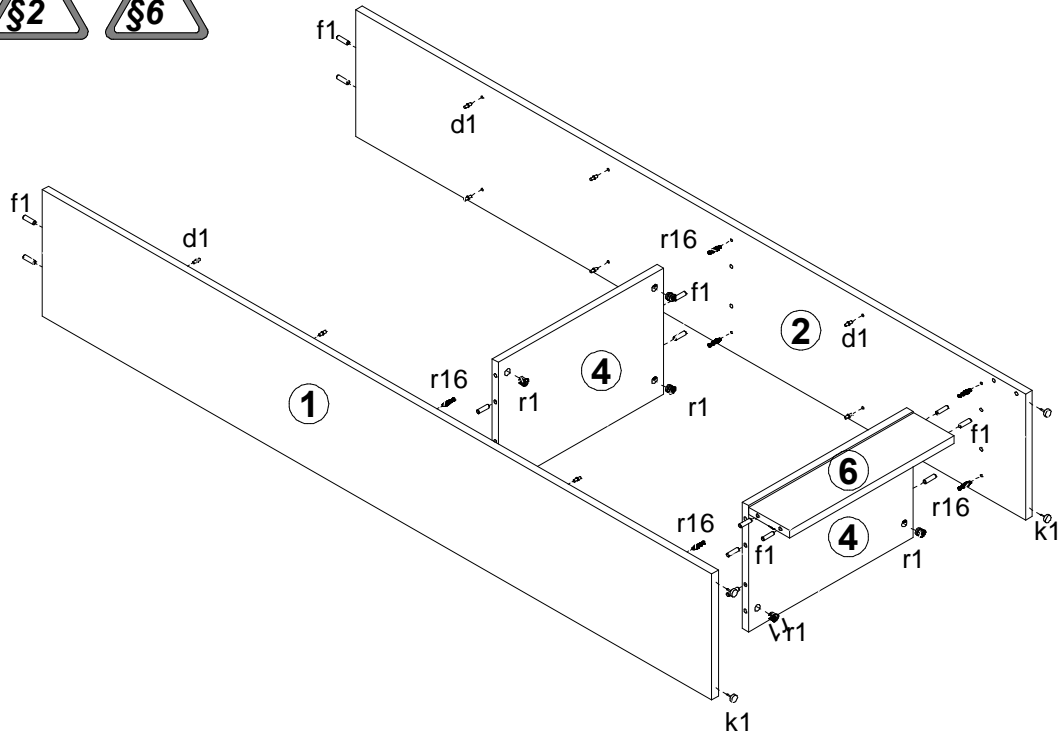

**2**

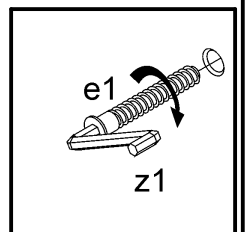
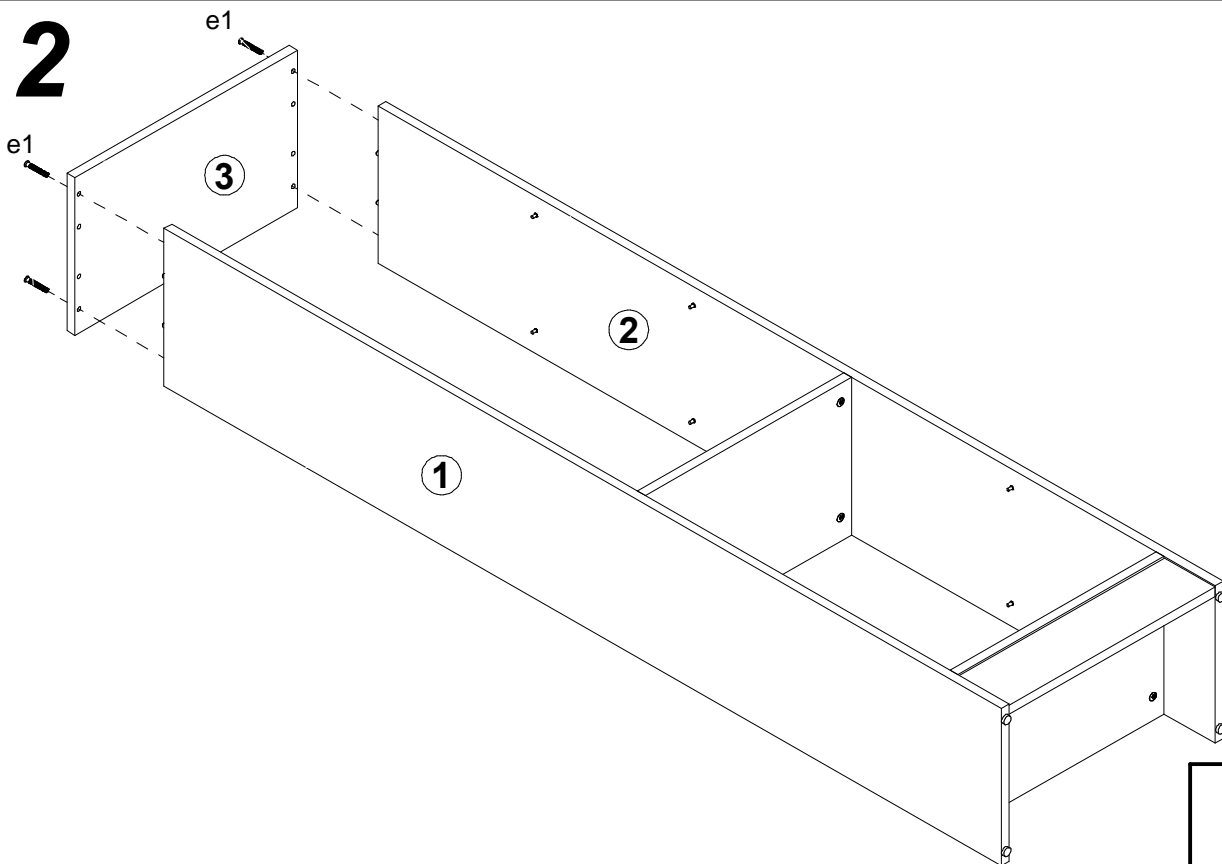

# 3

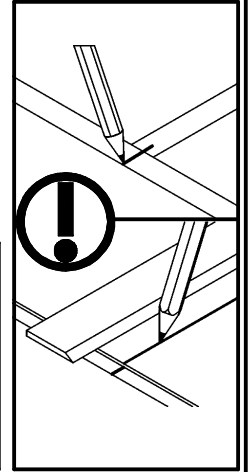
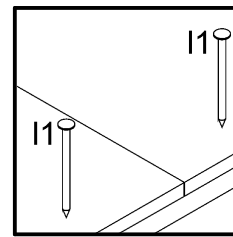
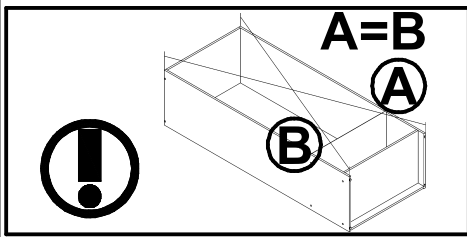
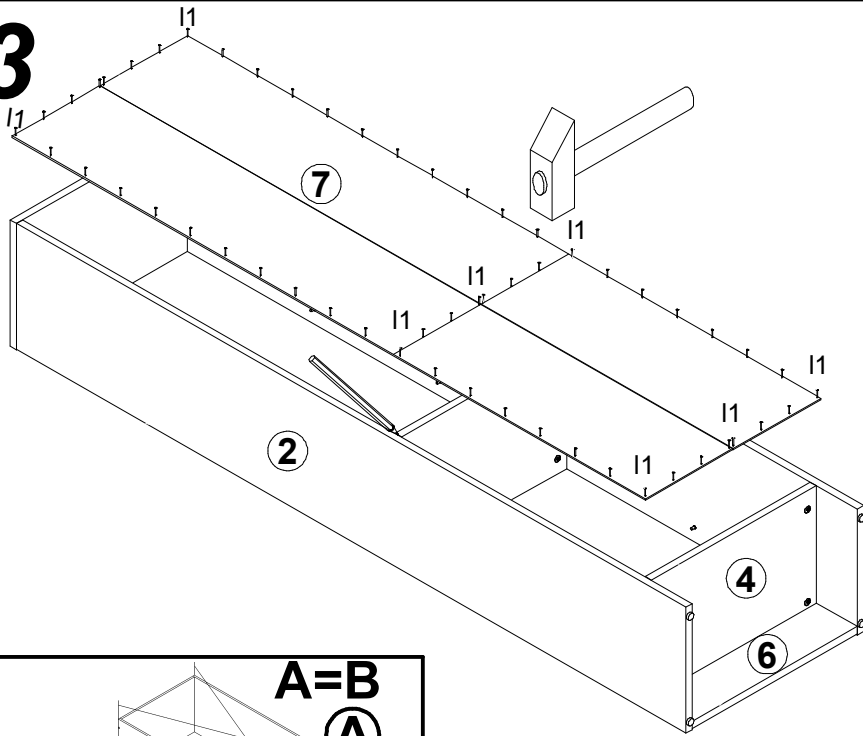

# 4

