

A	B	C	D	
1	S81-007	995	220	4/4
2	S81-115	737	371	1/4
3	S81-116	737	371	1/4
4	S81-209	1103	371	2/4
5	S81-210	1103	371	2/4
6	S81-579	1104	51	2/4
7	S81-584	774	51	2/4
8	S81-906	963	348	2/4
9	S81-910	761	1026	2/4
10	ZS1-533	350	160	2/4
11	ZS1-534	350	160	2/4
12	ZS1-6522	952	160	2/4

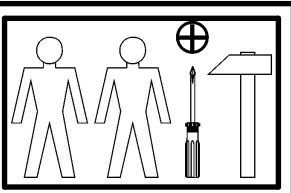

3x c237	4x φ7x50 mm e1	12x φ5x9 mm e19	16x φ6x20 mm e20	12x φ6x13 mm e3	20x φ8x30 mm f1	12x φ6.5x40 mm f25	6x M4x22 mm j30	4x k63
40x l1	6x φ3.5x16 mm p25	26x φ15x12mm #16 r1	4x r10	12x φ12x10.5mm #12 r15	30x r16	2x ø15 s51	3x 333 mm t19	3x 350 mm w45 CL
3x 350 mm w45 CR	3x 350 mm w45 DL	3x 350 mm w45 DR	1x z1	1x n26 1	1x φ3.5x16 mm p38			

1 §2 §6

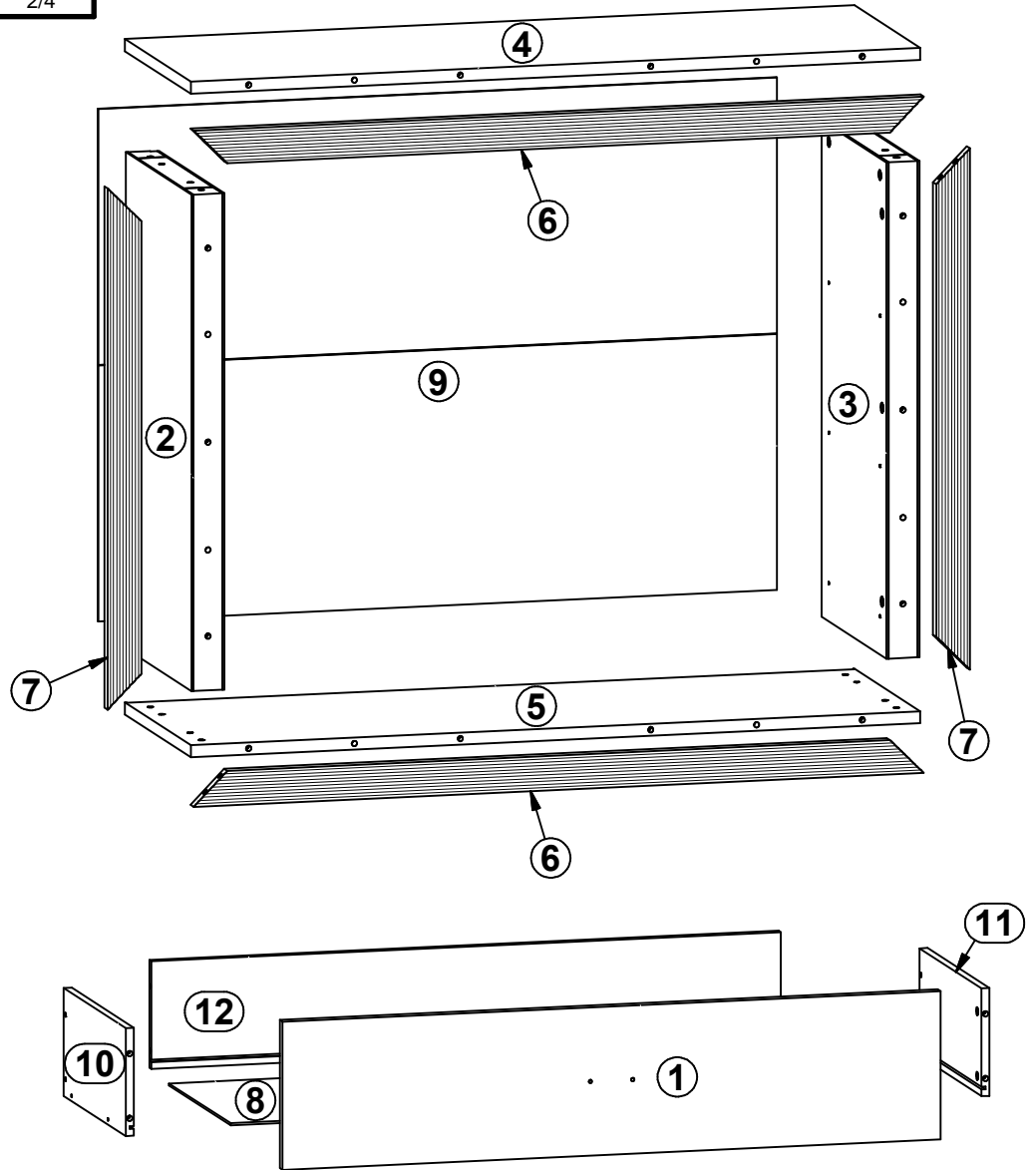
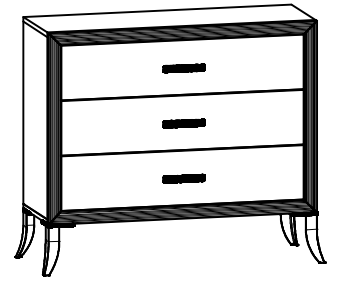
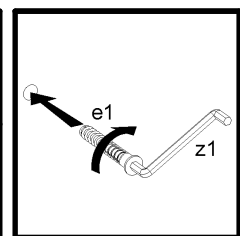
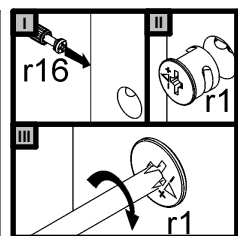
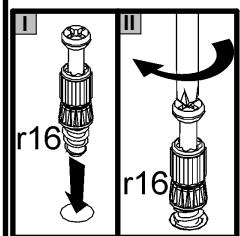
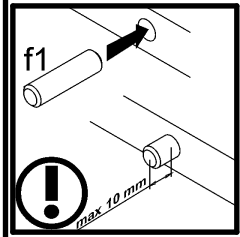
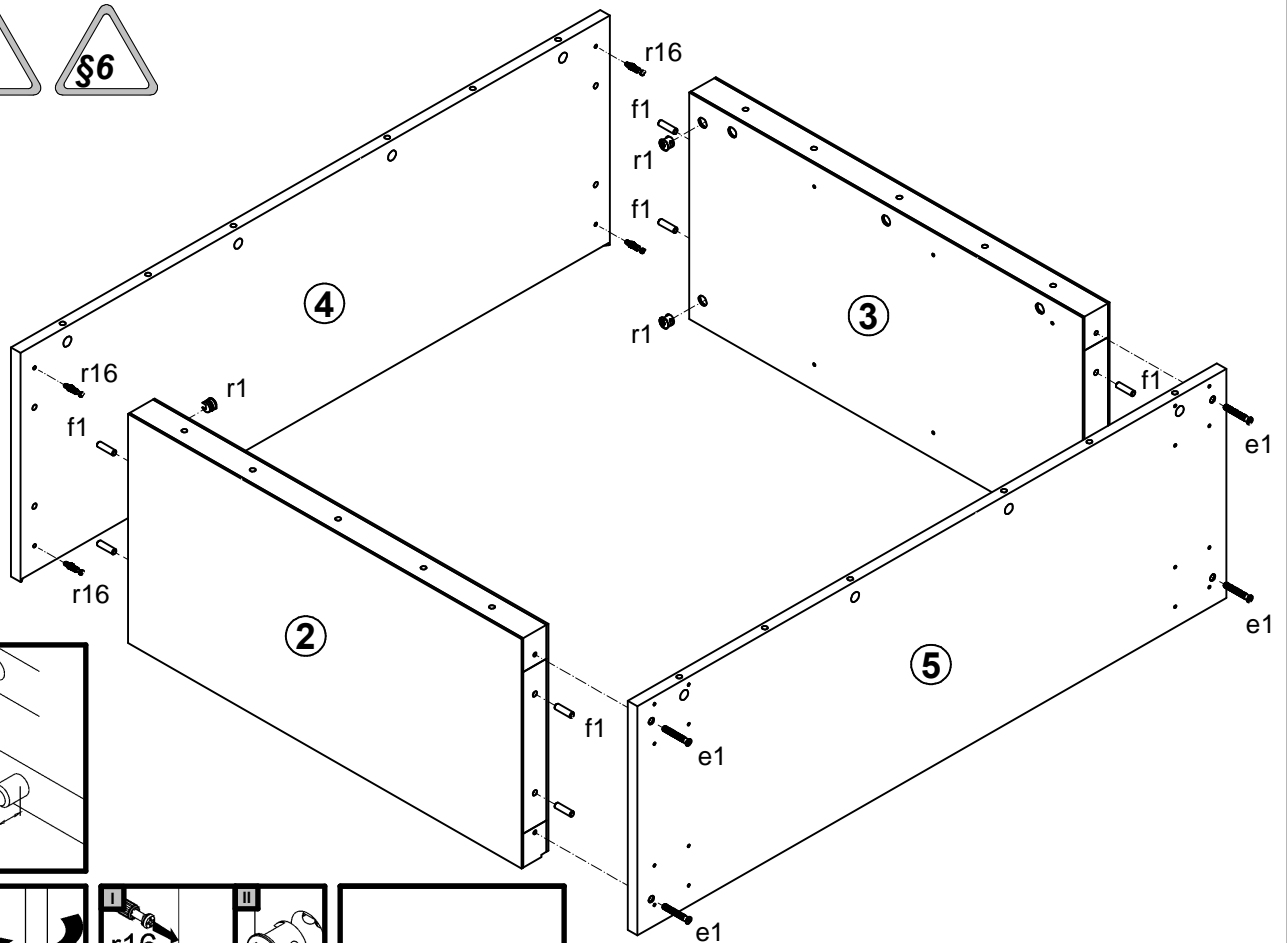

2

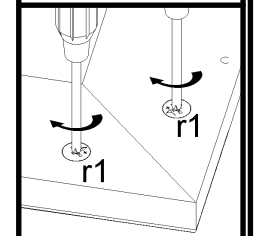
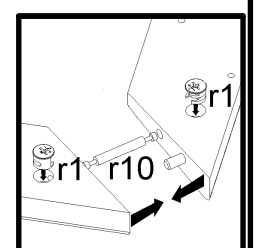
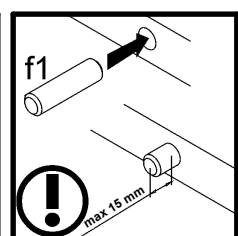
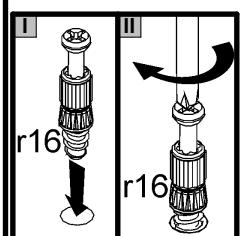
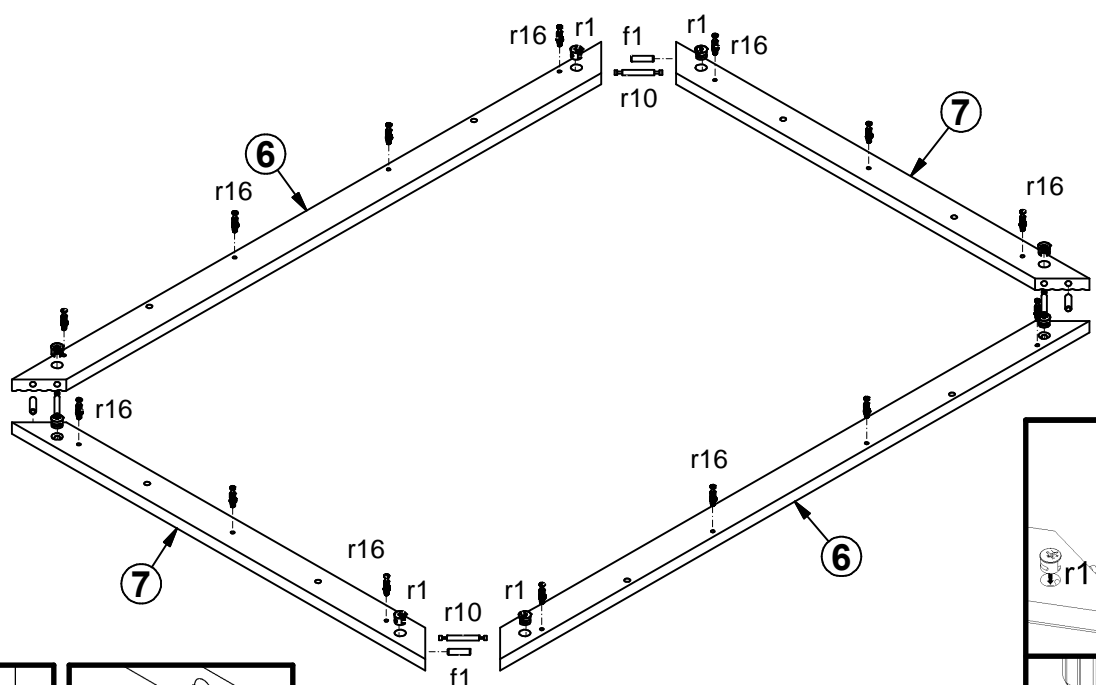

3

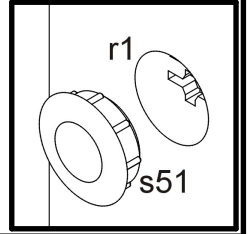
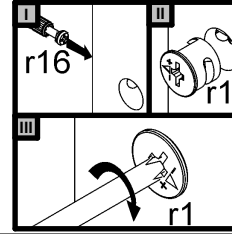
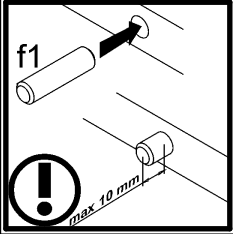
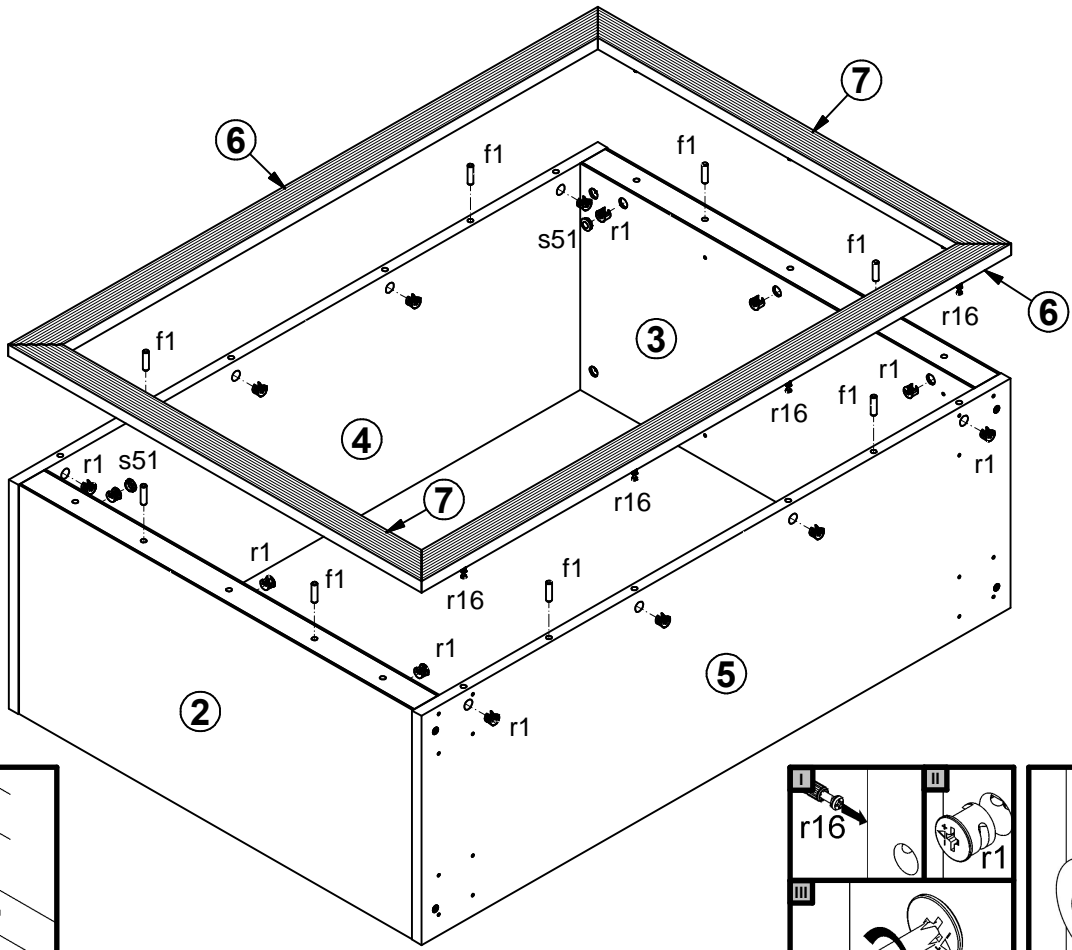

4

