

A	B	C	D	
1	S81-010	496	220	4/4
2	S81-117	960	371	1/4
3	S81-118	960	371	1/4
4	S81-211	604	371	2/4
5	S81-212	604	371	2/4
6	S81-585	605	51	1/4
7	S81-586	997	51	1/4
8	S81-911	464	348	1/4
9	S81-912	984	527	1/4
10	ZS1-533	350	160	2/4
11	ZS1-534	350	160	2/4
12	ZS1-6525	453	160	2/4

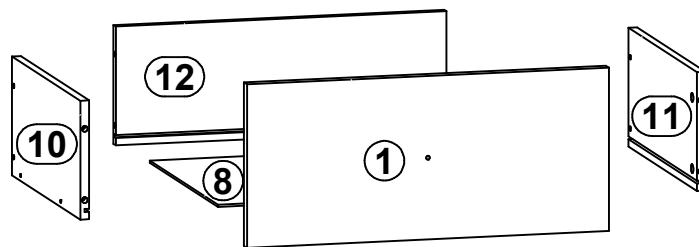

4x c236\1	4x e1 φ7x50 mm	16x e19 φ8x9 mm	16x e20 φ8x20 mm	16x e3 φ6x13 mm	20x f1 φ8x30 mm	16x f25 φ6.5x40 mm	4x j30 M4x22 mm	4x k63	
35x l1	24x r1 φ15x12mm #16	4x r10	16x r15 φ12x10.5mm #12	32x r16	2x s51 ø15	4x w45\CL 350 mm	4x w45\CR 350 mm	4x w45\DL 350 mm	
4x w45\DR 350 mm	1x z1	1x n26\1	1x p38 φ3.5x16 mm						

1

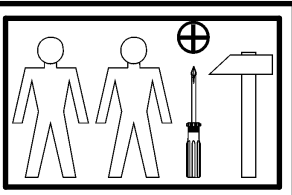
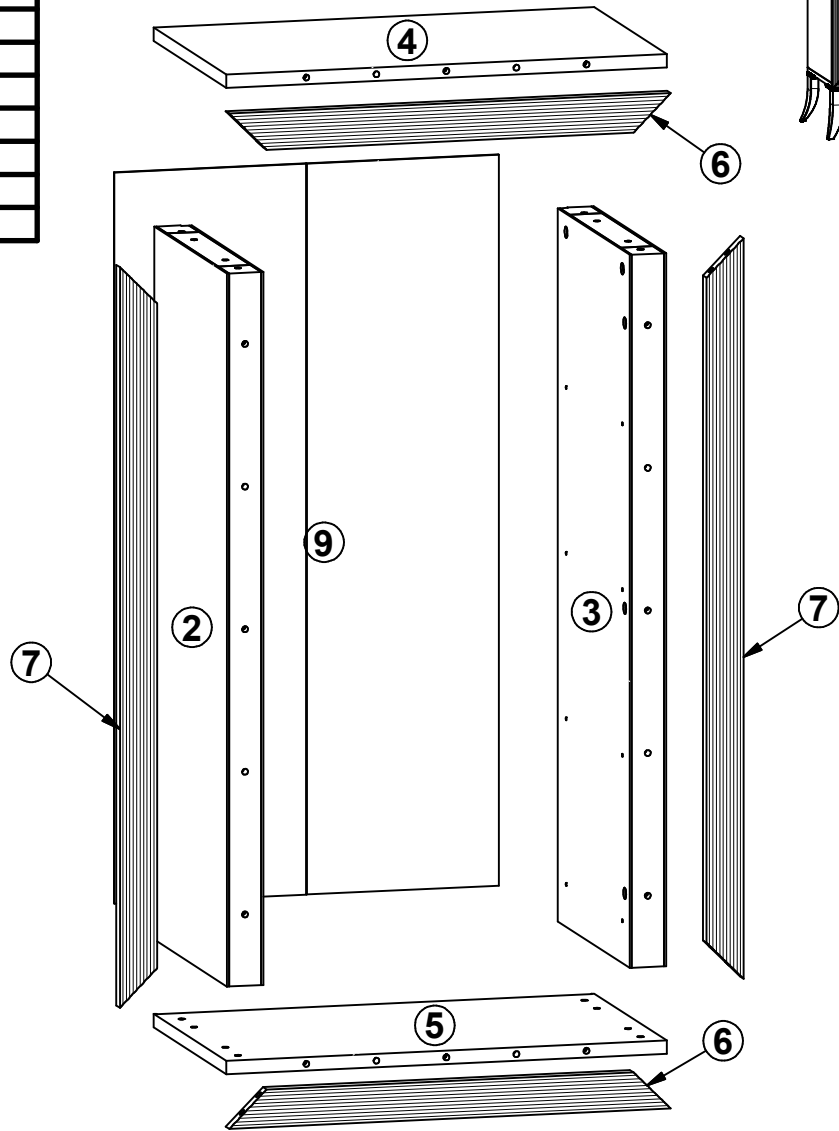
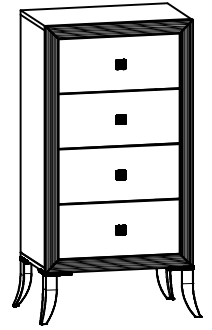
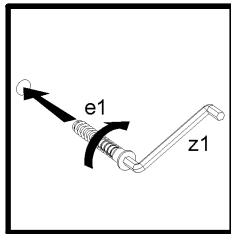
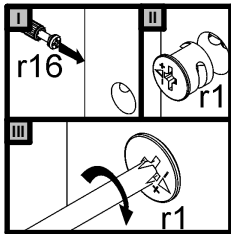
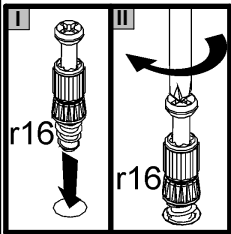
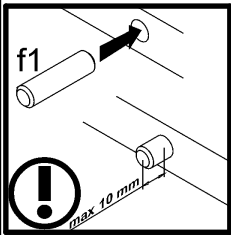
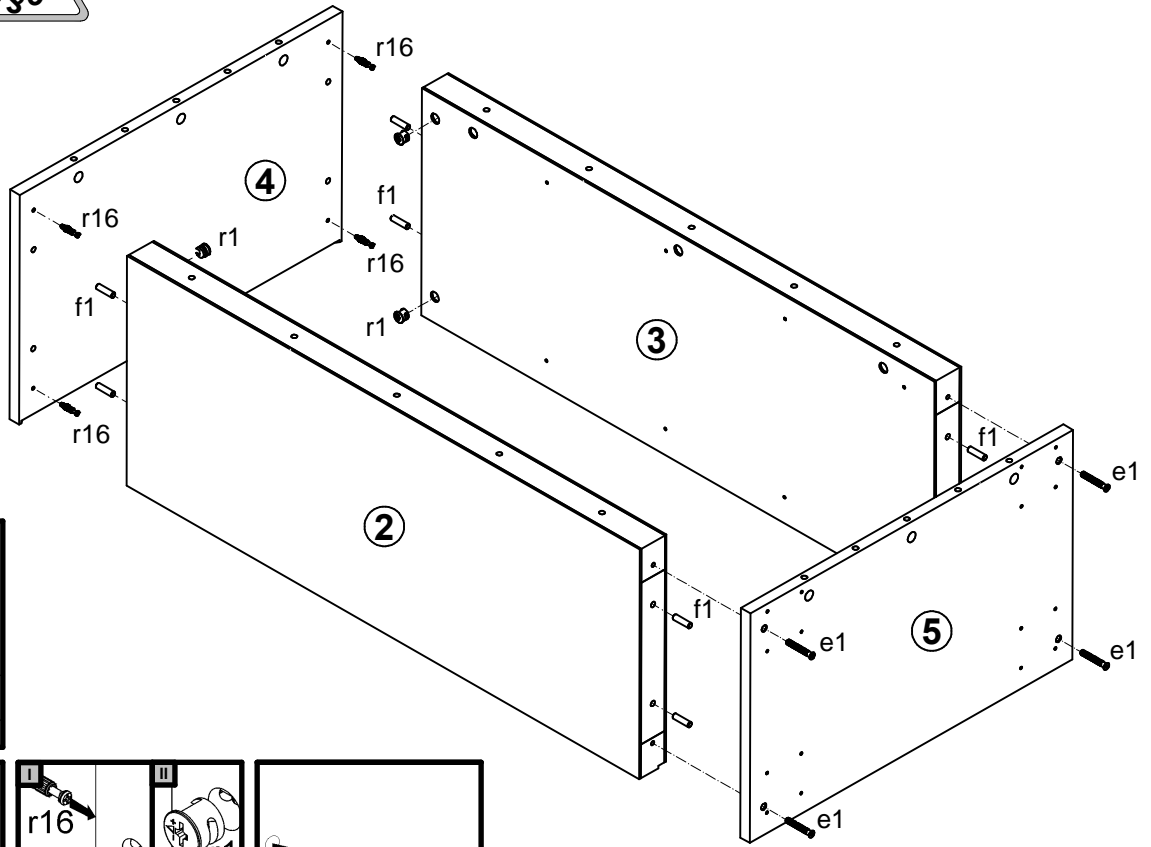

2

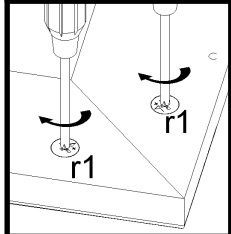
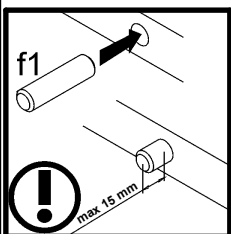
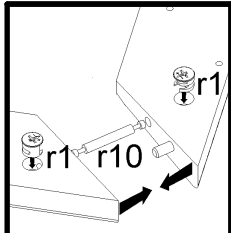
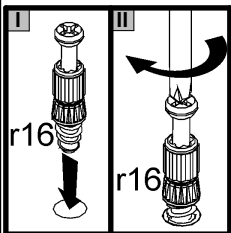
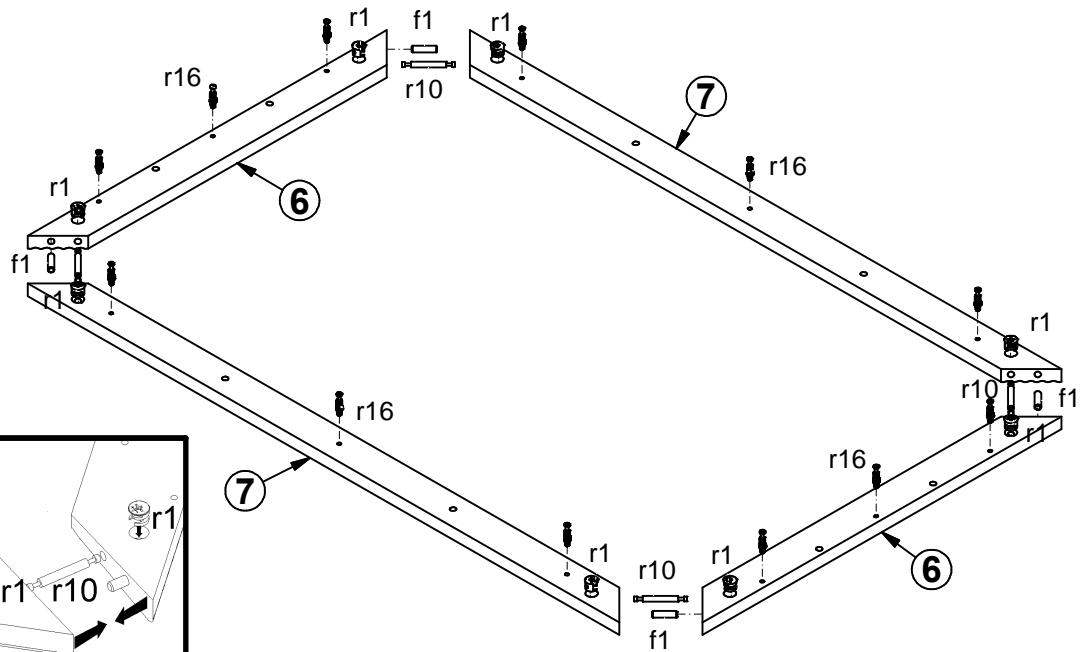

3

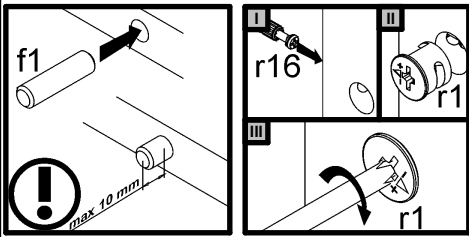
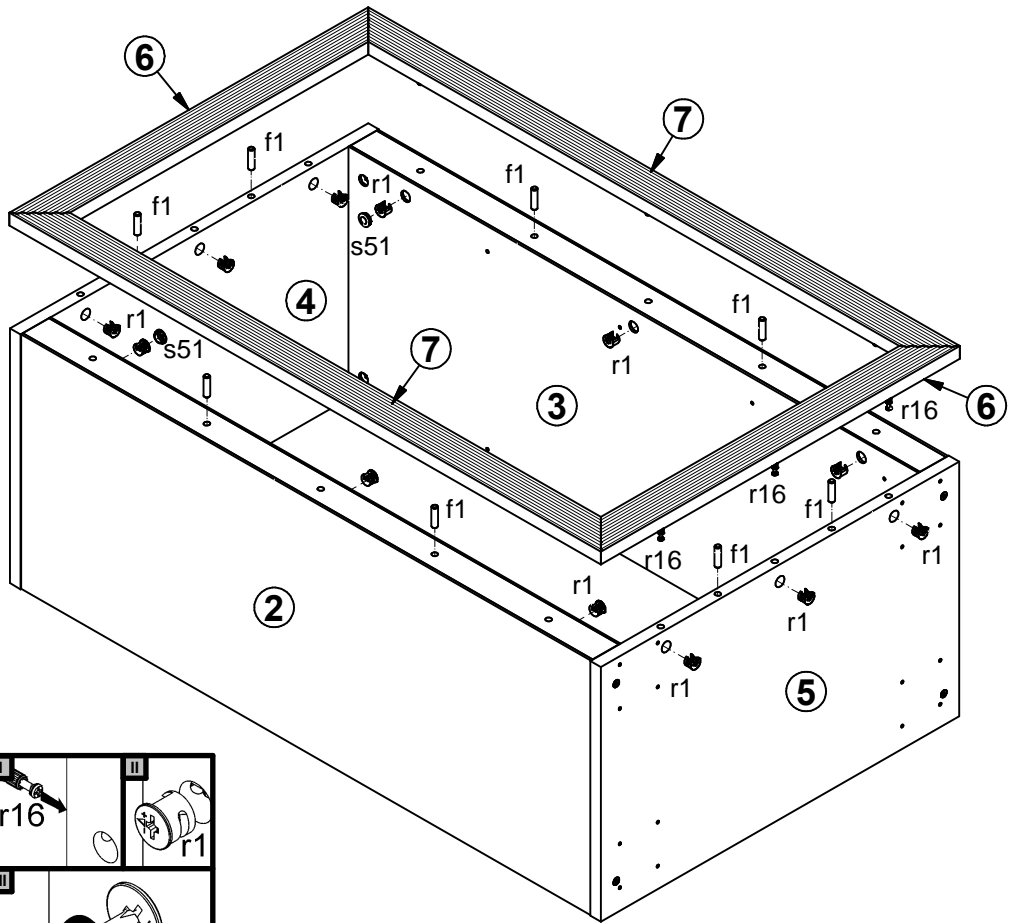

4

