

# SMILE

S72-REG/20/7

A	B	C	D
1	S72-119	1814	375 1/2
2	S72-120	1814	375 1/2
3	S72-213	678	376 2/2
4	S72-214	678	376 2/2
5	S72-308	600	355 2/2
6	S72-309	602	355 2/2
7	S72-916	1851	641 1/2

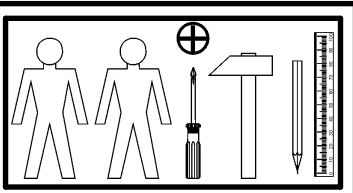
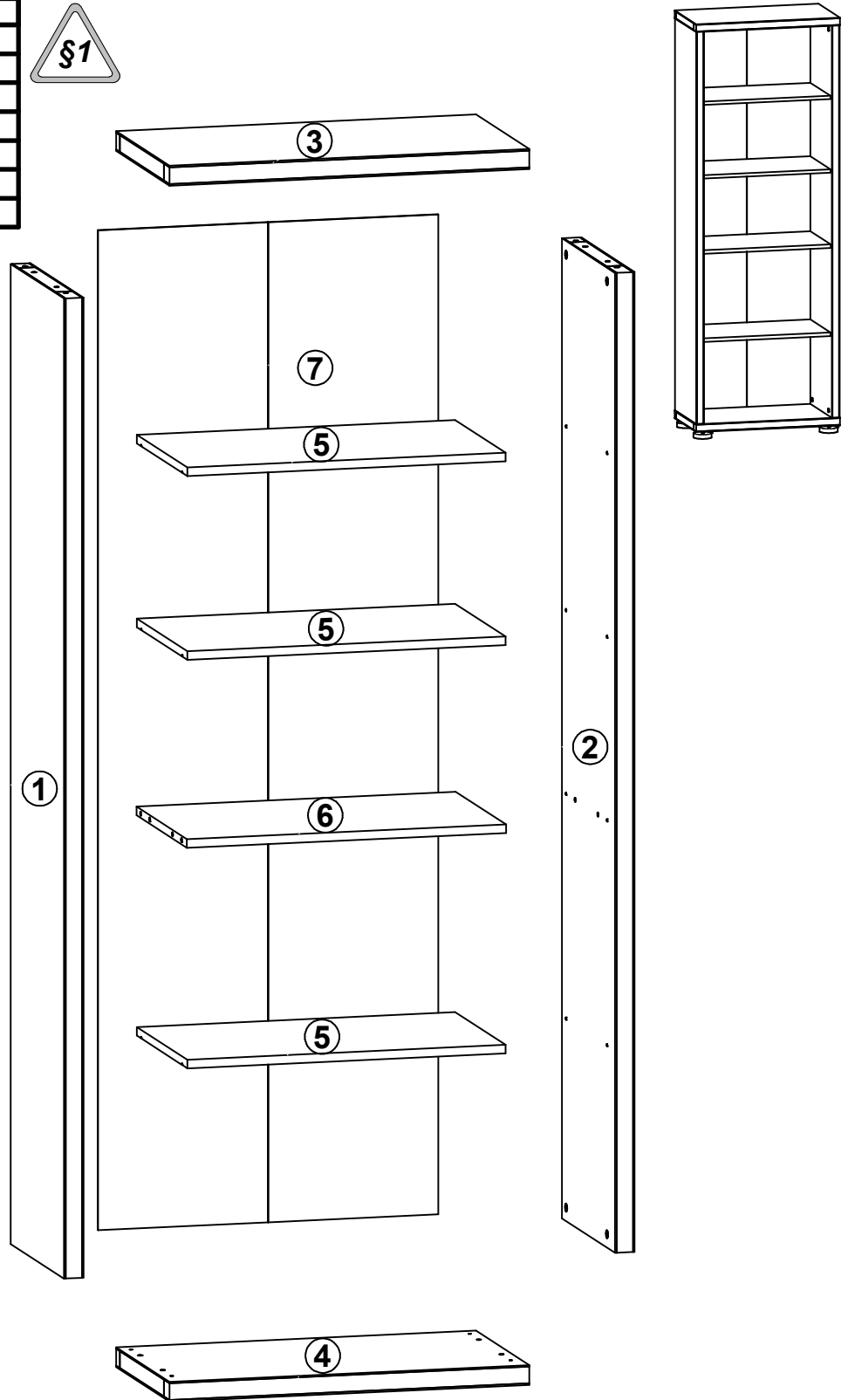

12x φ5x17 mm d1	12x φ8x30 mm f1	4x k62\1	4x k62\2	55x l1	12x φ1.5x12mm #16 r1	12x r42	4x ø16 s2	8x ø15 s51
1x n26\1	1x φ3.5x16 mm p38							

**1** §2 §6

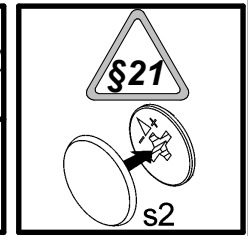
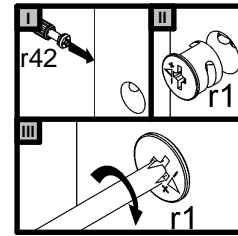
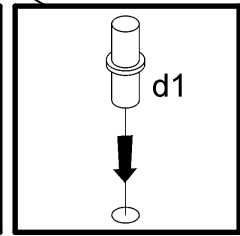
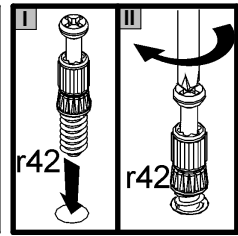
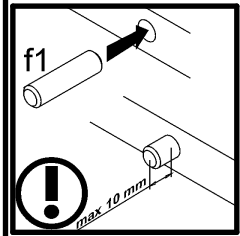
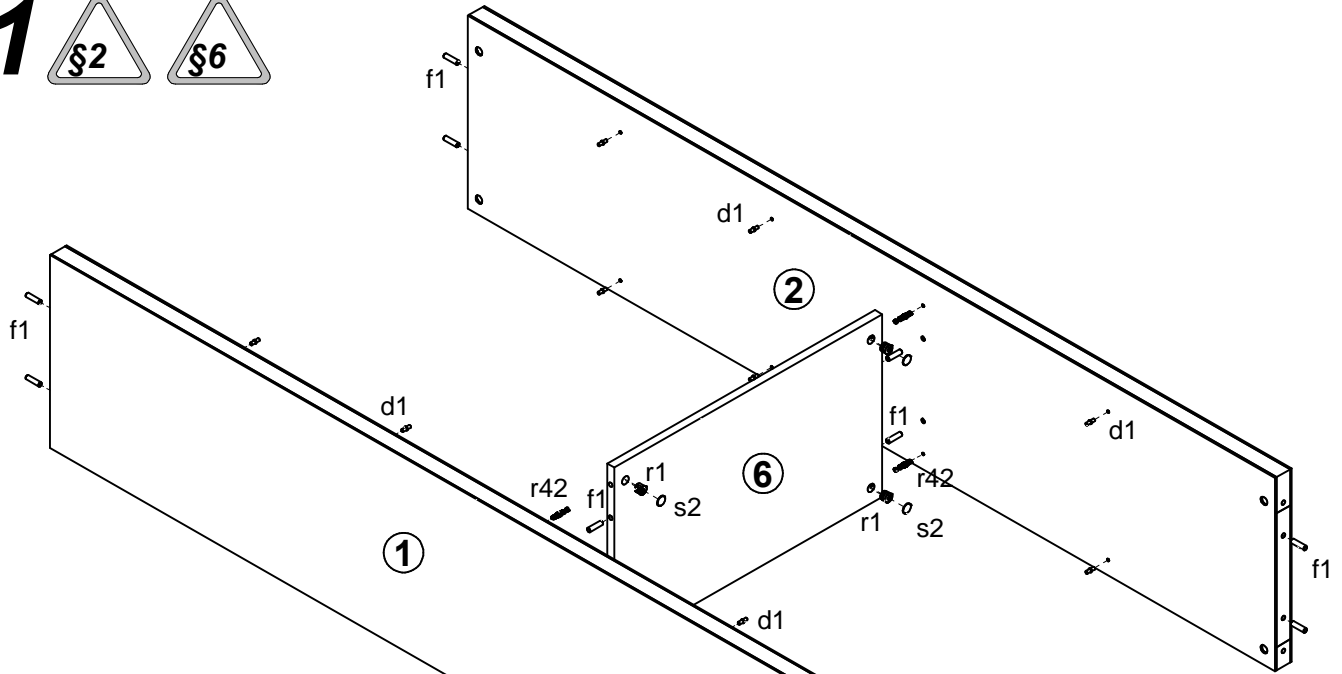

**2**

