

SMILE

S72-SZF5D2S

A	B	C	D	A	B	C	D		
1	S72-006	380	446	4/5	13	S72-208	1428	560	2/5
2	S72-007	380	446	4/5	14	S72-301	1352	559	2/5
3	S72-010	1402	446	5/5	15	S72-305	441	538	3/5
4	S72-011	1402	446	5/5	16	S72-307	443	539	3/5
5	S72-029	446	189	4/5	17	S72-907	1851	919	1/5
6	S72-030	446	188	4/5	18	S72-908	1851	469	1/5
7	S72-109	1814	559	1/5	19	S72-909	396	498	3/5
8	S72-110	1814	559	1/5	20	ZS1-503	500	120	3/5
9	S72-111	388	537	3/5	21	ZS1-504	500	120	3/5
10	S72-112	388	537	3/5	22	ZS1-6540	385	120	3/5
11	S72-113	1410	539	2/5	23	dr-887	887	22	2/5
12	S72-207	1428	560	2/5					

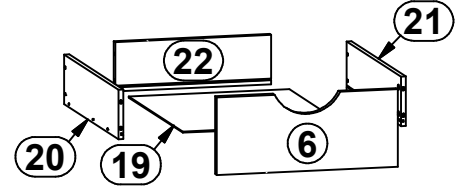
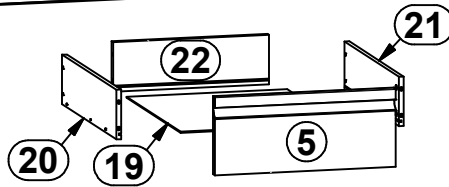
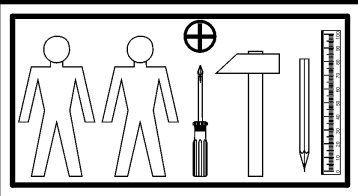
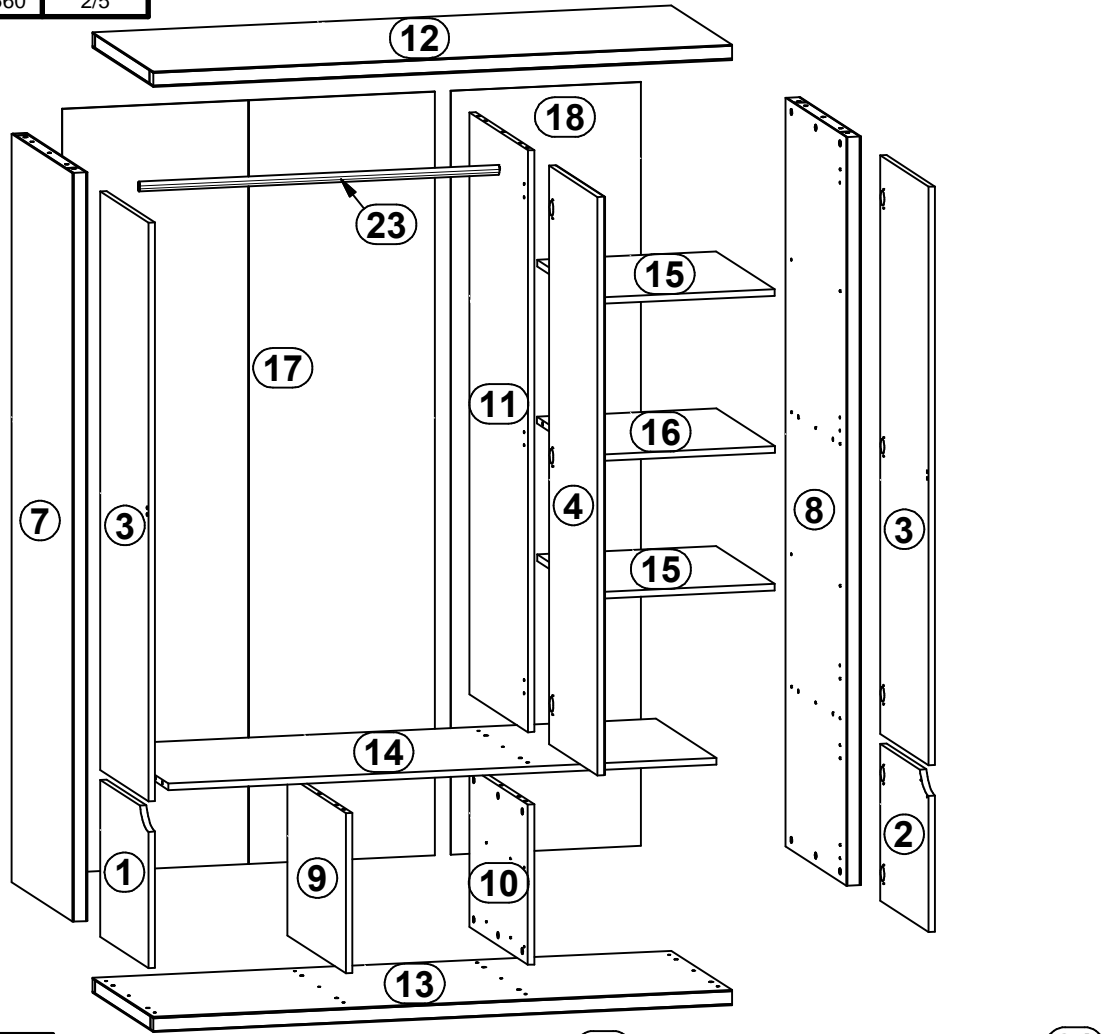
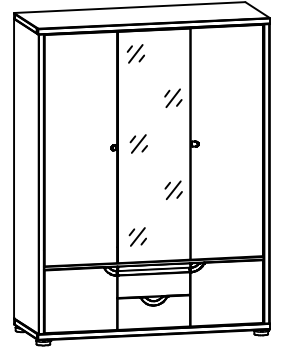

10x a43	3x a68	13x b33	1x c231\1L	1x c231\1P	1x c231\2L	1x c231\2P	1x c233\1	1x c233\2
2x c234	8x d1	2x d4	12x e19	26x e2	12x e3	28x f1	8x f25	4x j83
6x k62\1	6x k62\2	130x l1	2x n1	8x p1	26x p51	7x p93	42x r1	8x r15
50x r42	14x s2	12x s51	2x w26\CL	2x w26\CR	2x w26\DL	2x w26\DR		

1 

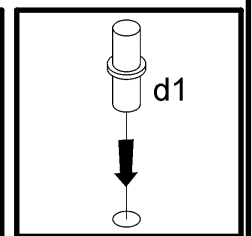
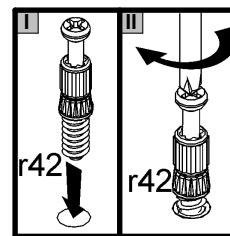
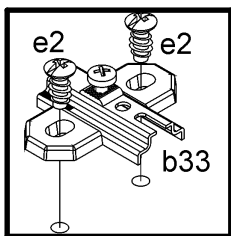
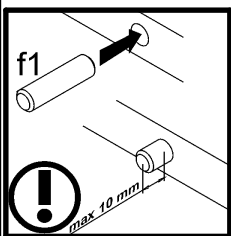
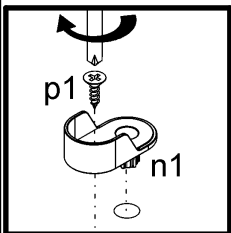
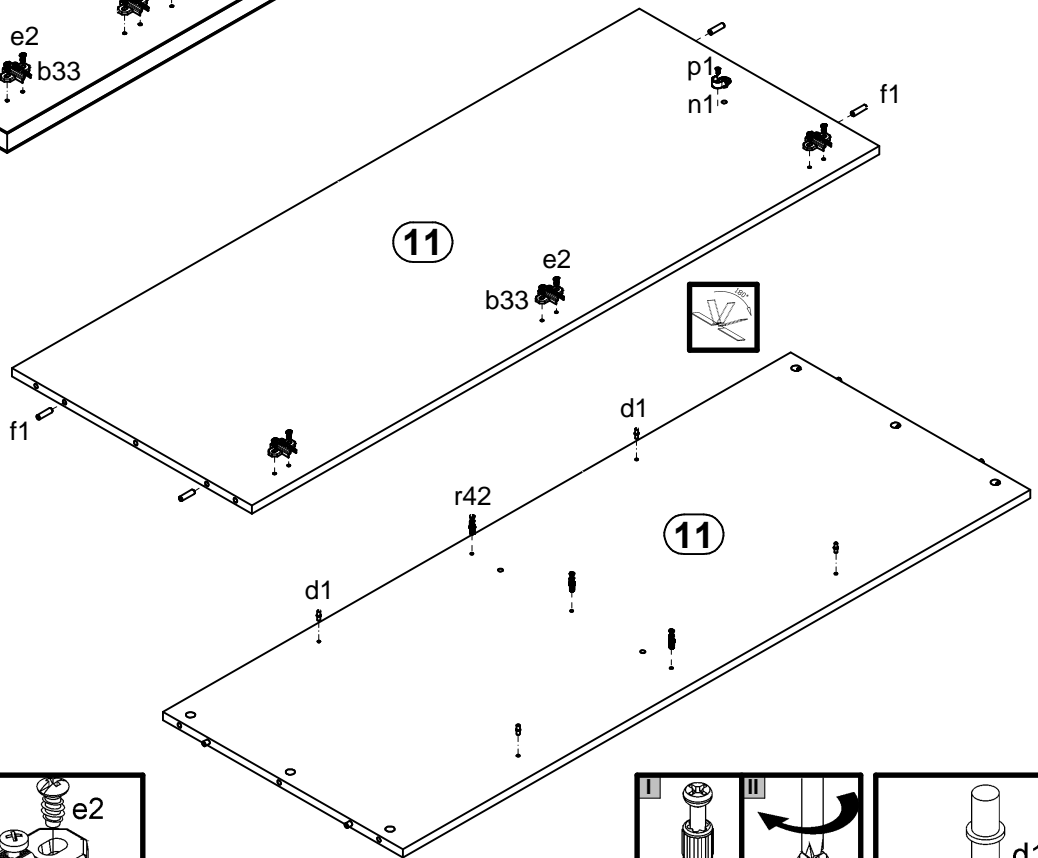
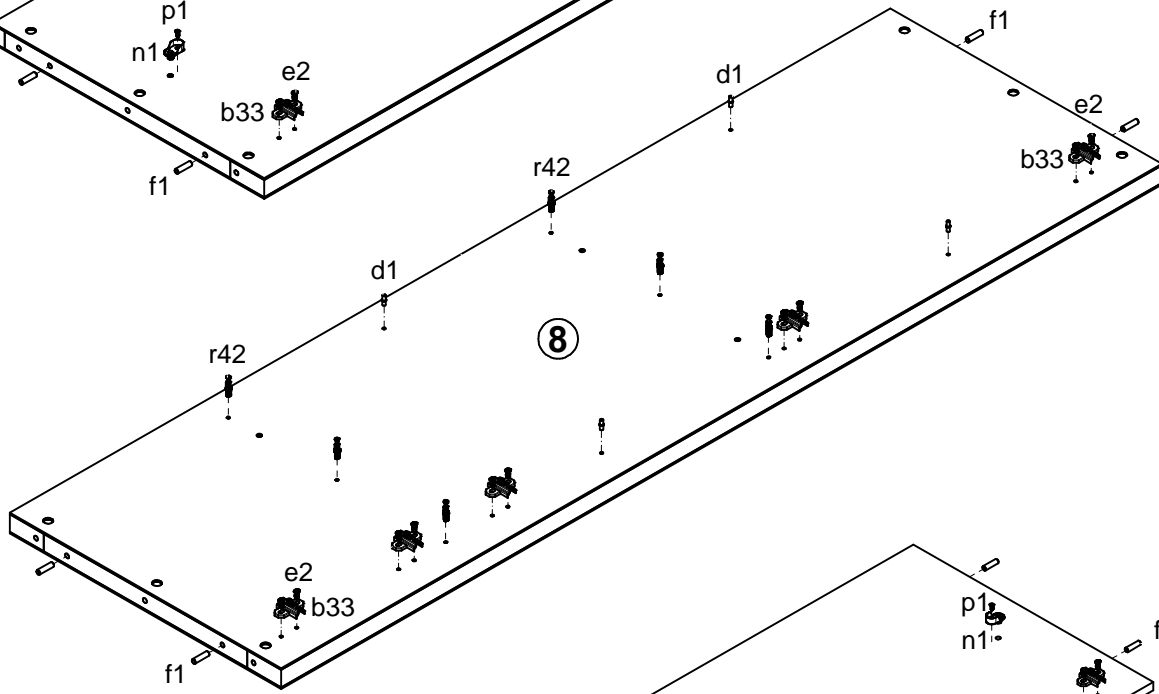
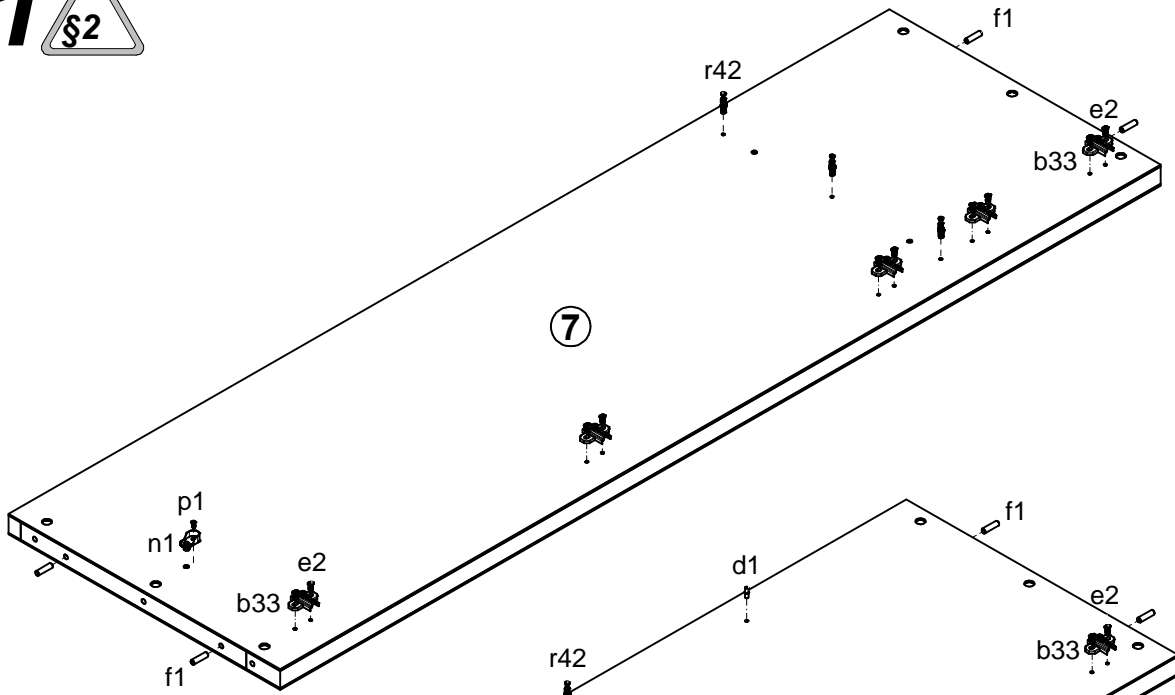

2

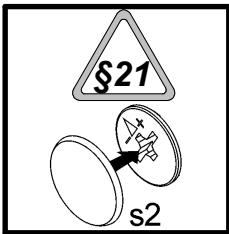
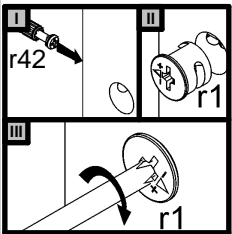
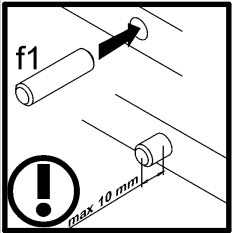
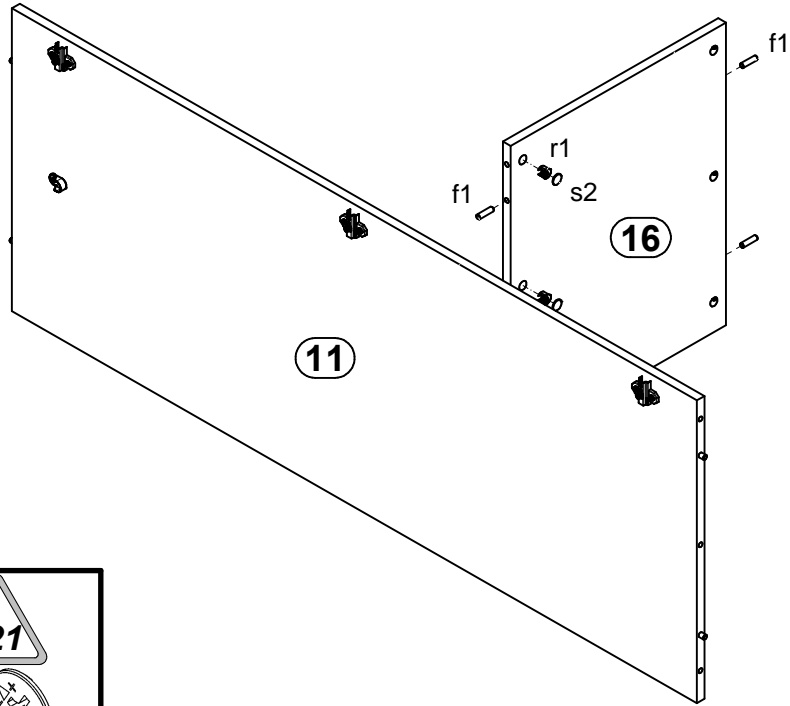

3

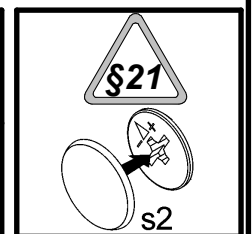
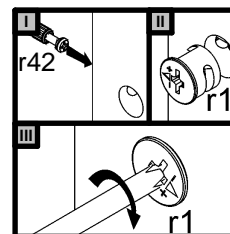
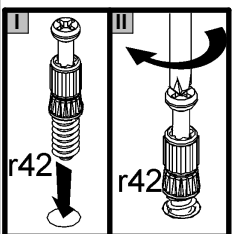
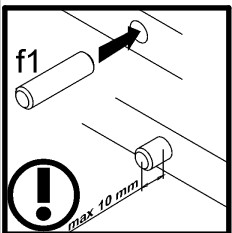
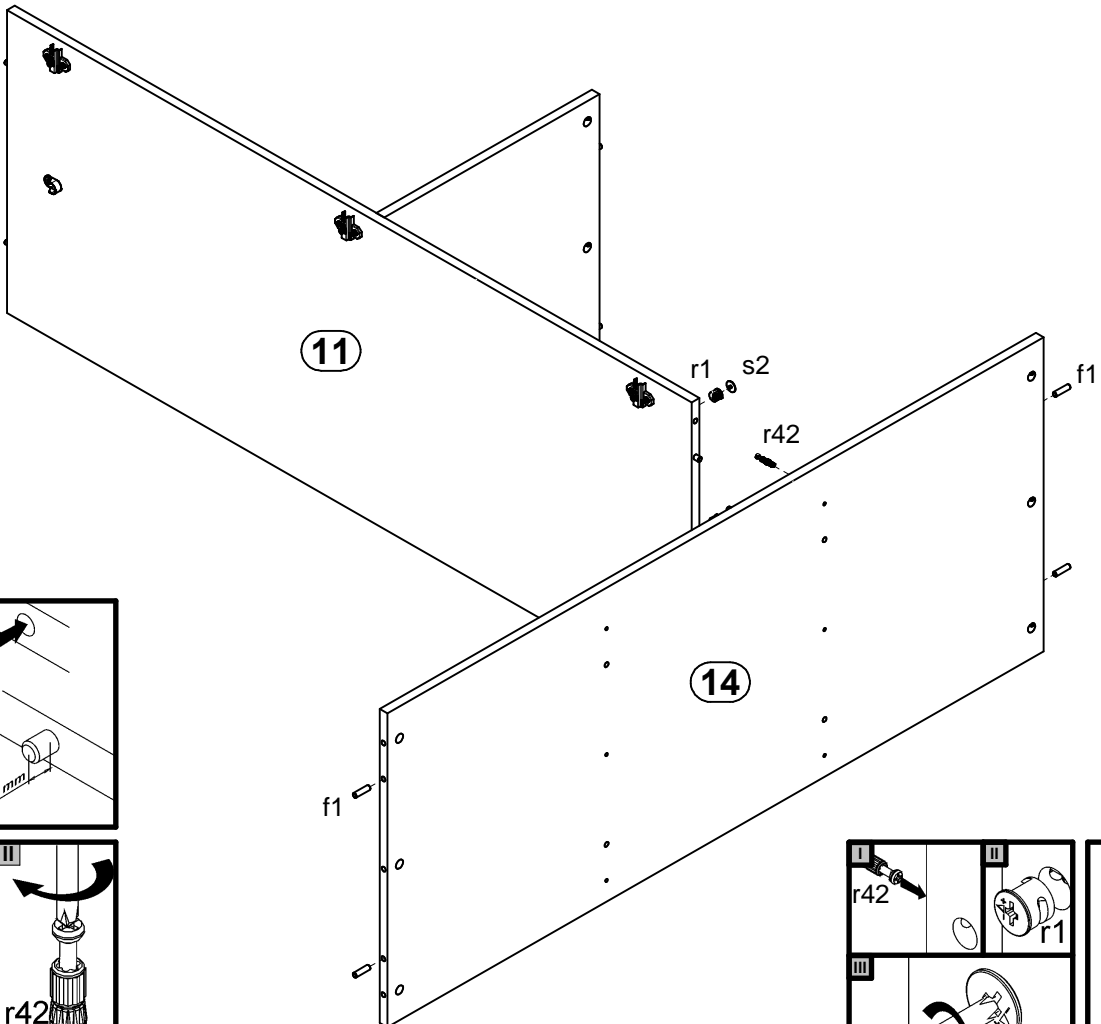

4

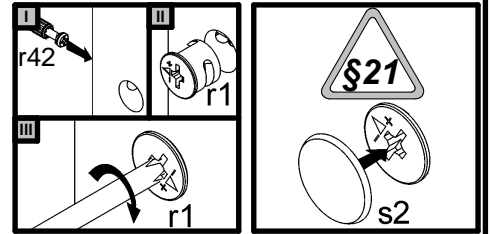
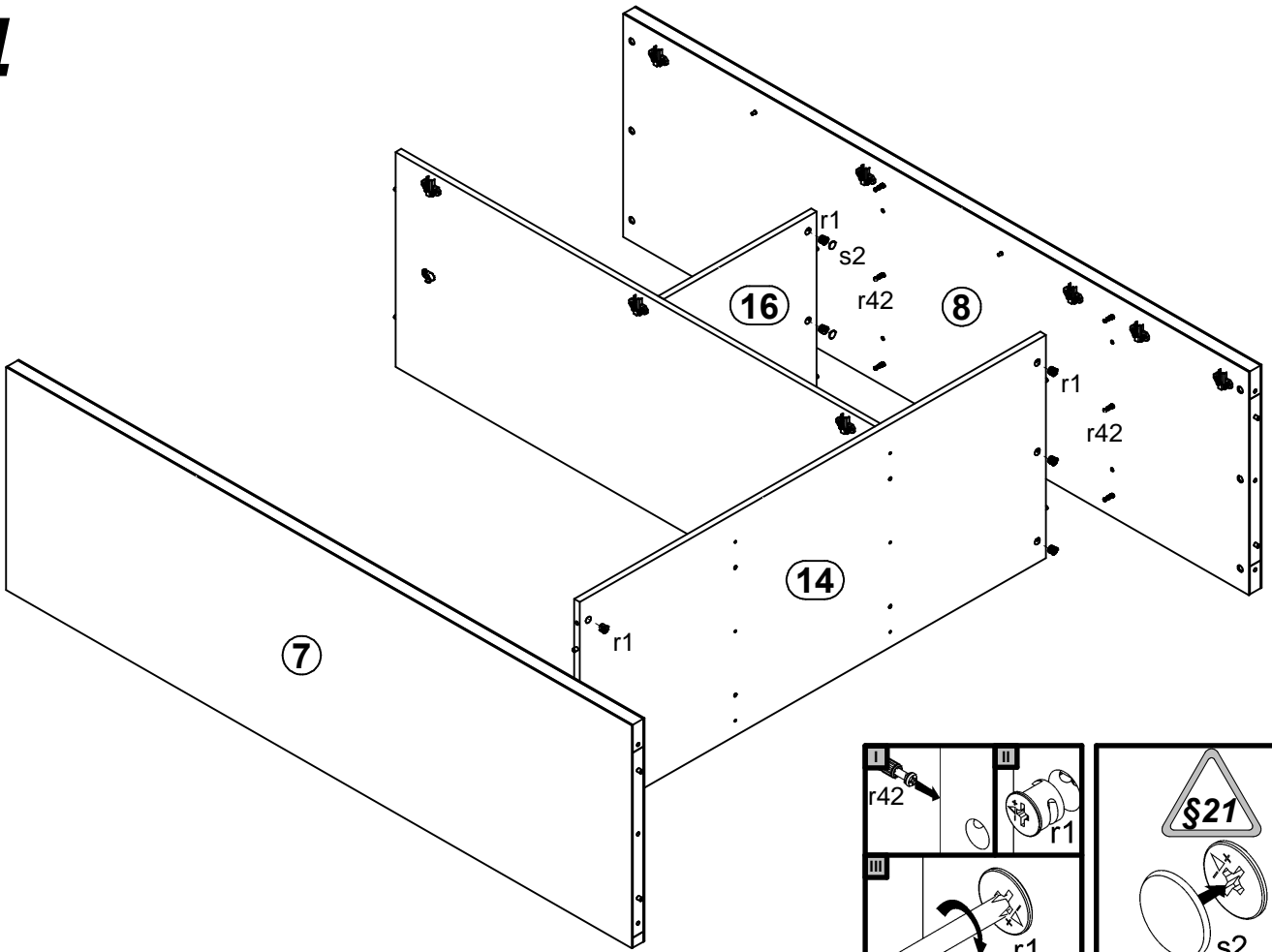

5

