

# TAAO

## S73-RCD/18

A	B	C	D
1	S73-111	714	179
2	S73-205	185	179
3	S73-305	148	160
4	S73-417	714	148



2

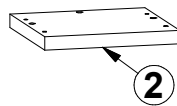
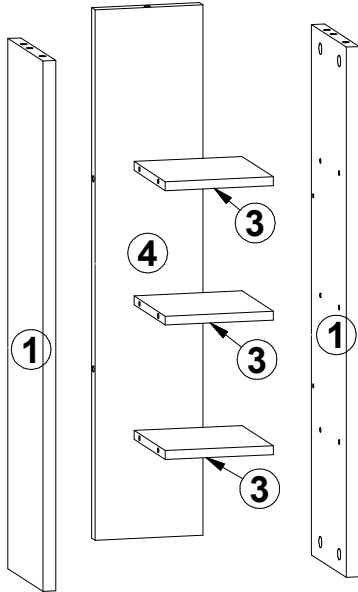
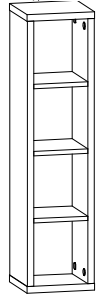
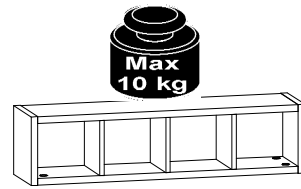

2

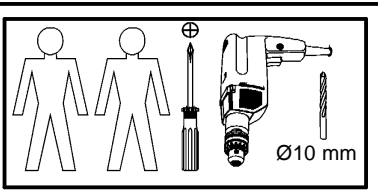

1

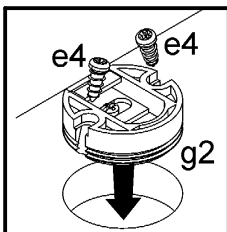
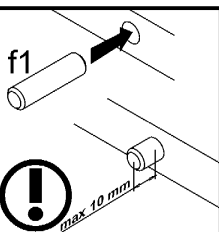
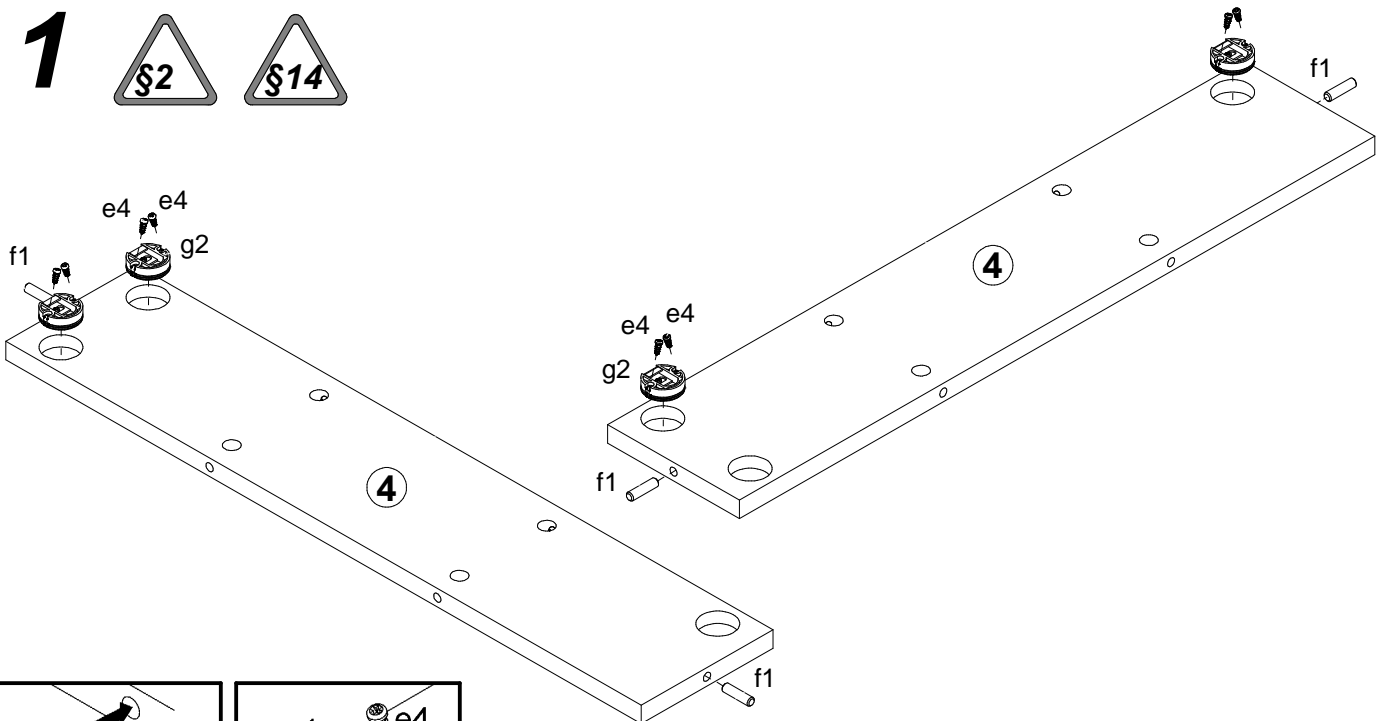

# 2

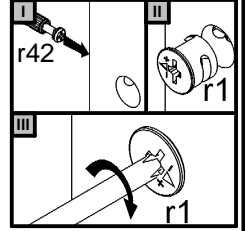
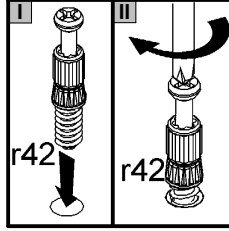
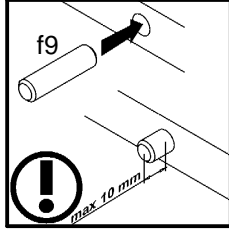
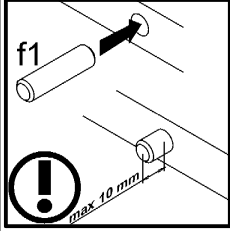
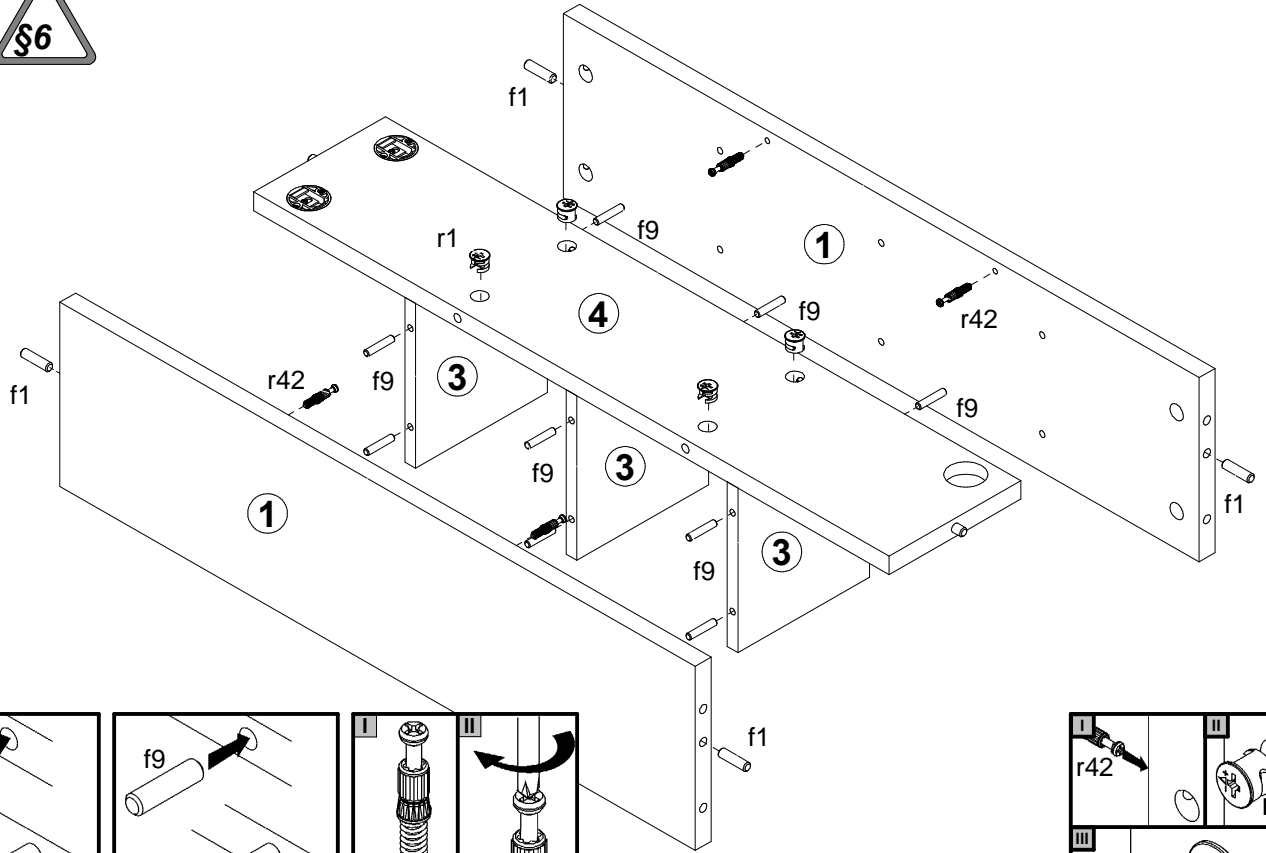

# 3

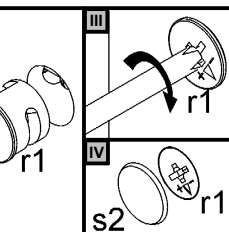
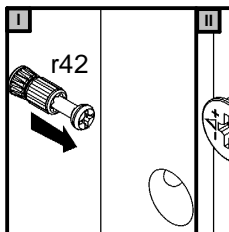
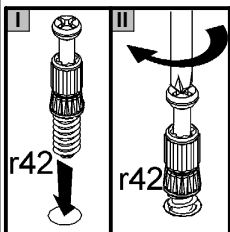
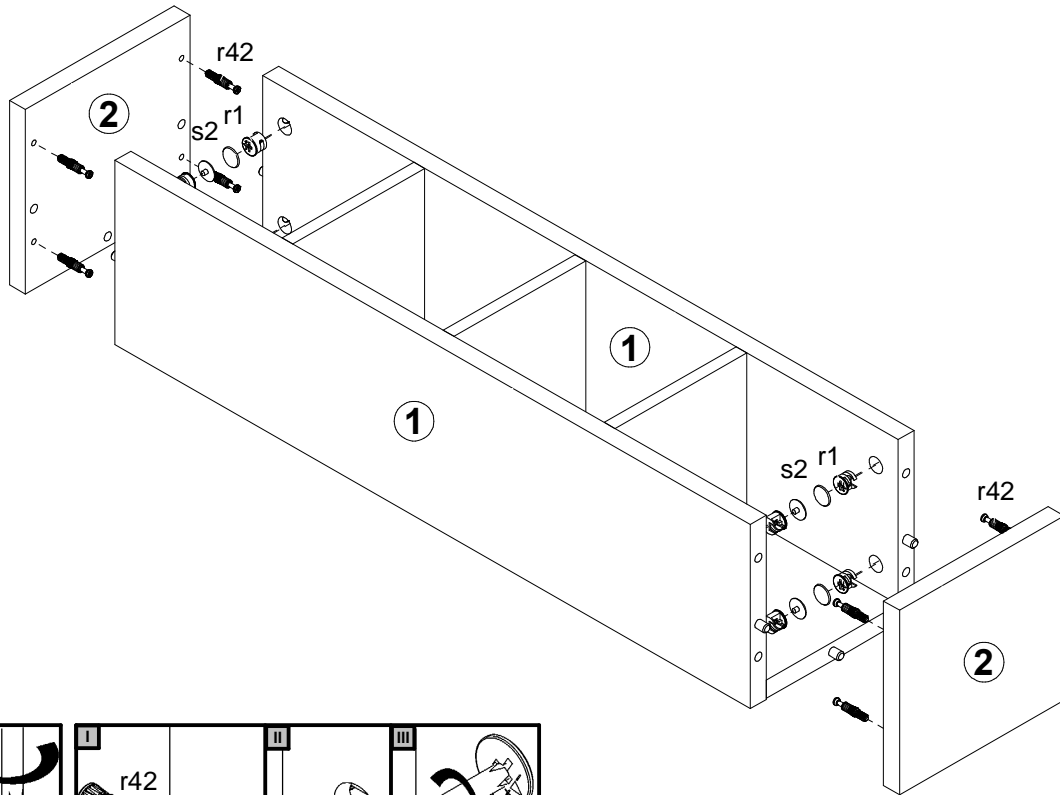

4



98 mm 43,5 mm

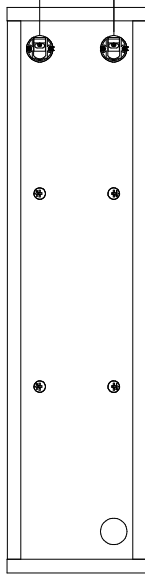

640 mm

55 mm

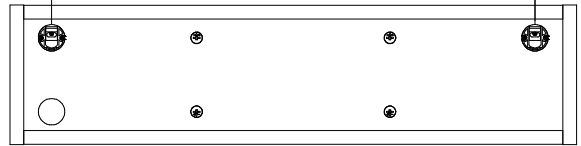

f35 p75

f35 p75

f35 p75

f35 p75

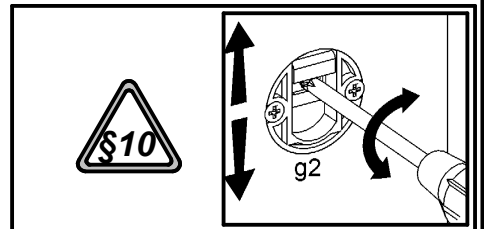
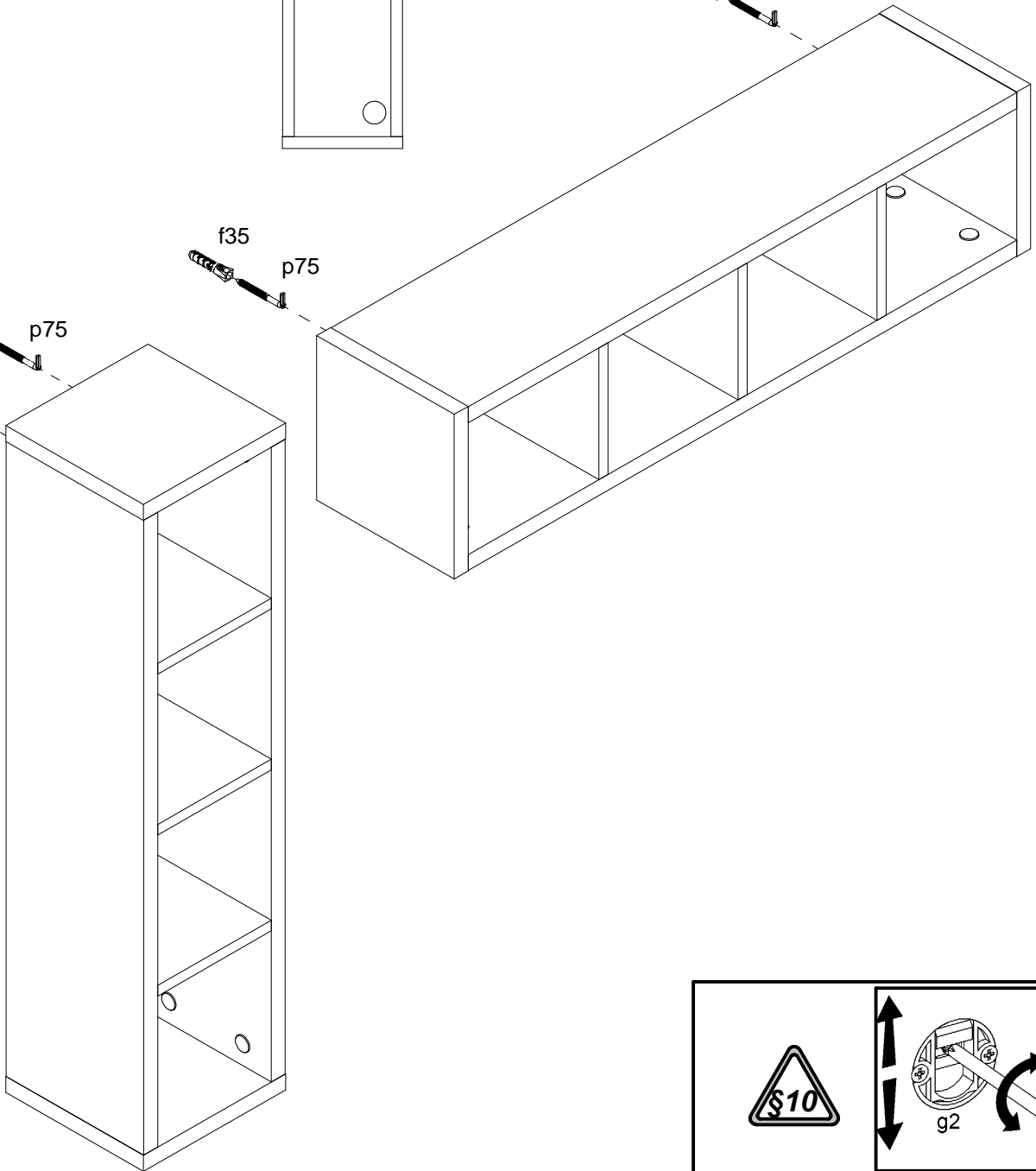

φ10 mm

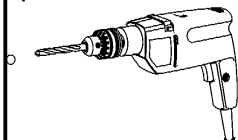

I

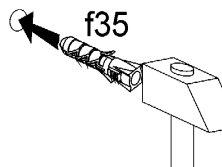

II

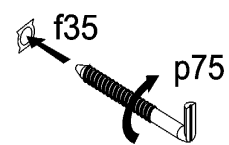

III

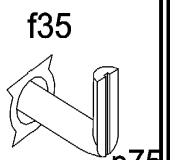

IV

p75