

A	B	C	D
1	S79-113	2188	500 1/3
2	S79-114	2188	500 1/3
3	S79-215	1130	500 2/3
4	S79-312	1064	500 2/3
5	S79-405	2155	1063 3/3

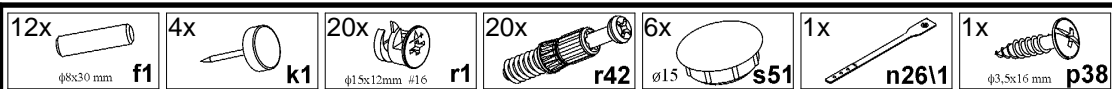

# 1

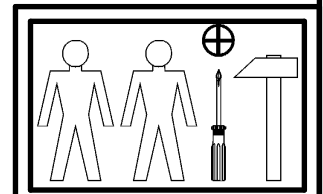
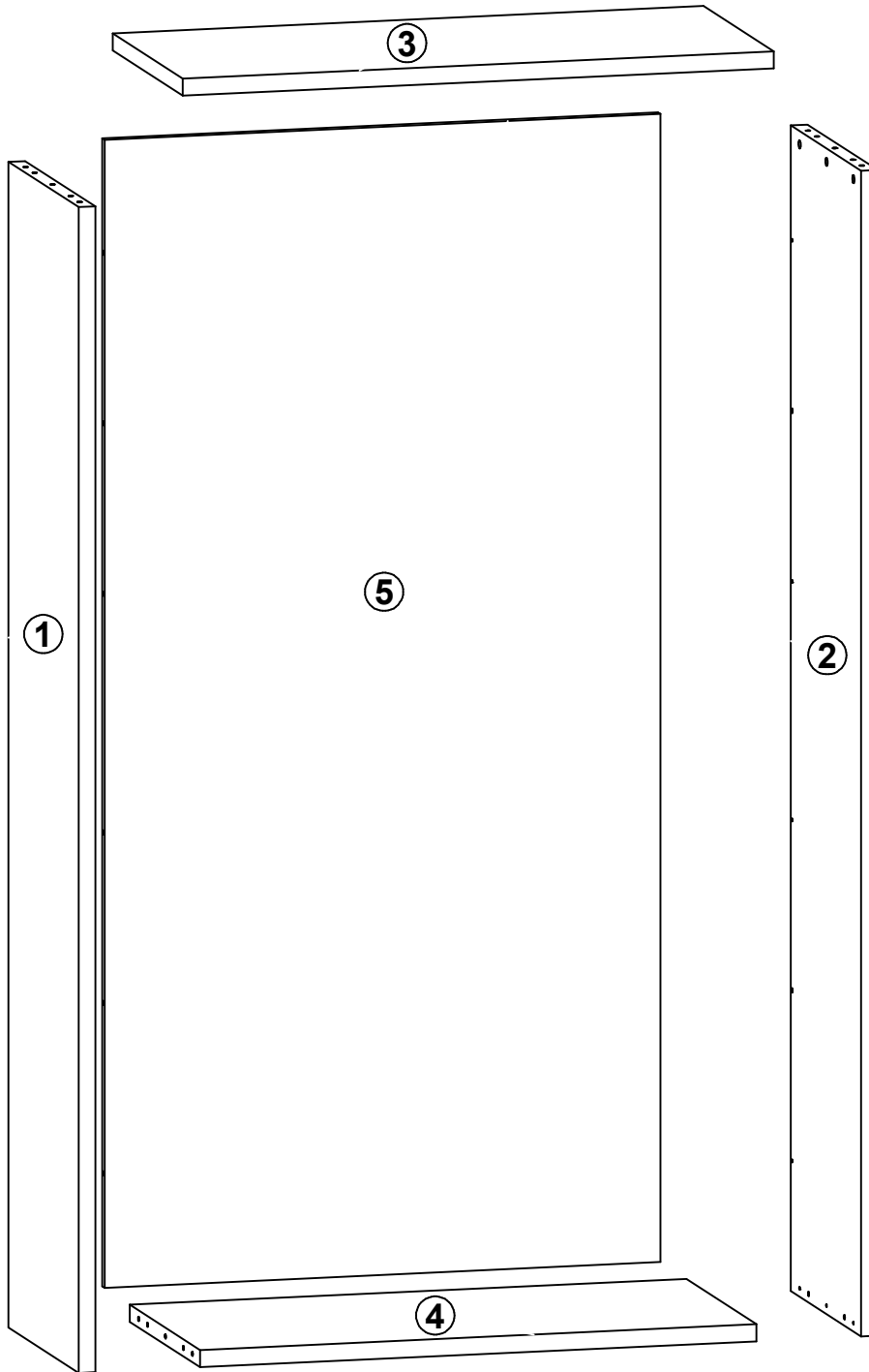
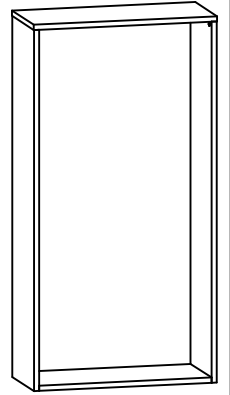
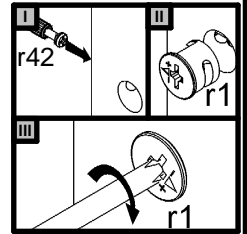
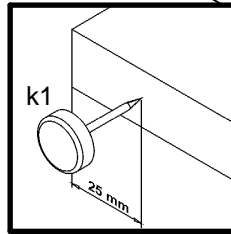
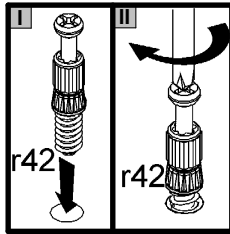
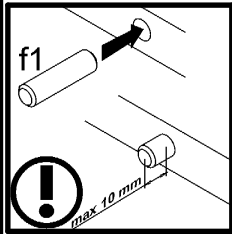
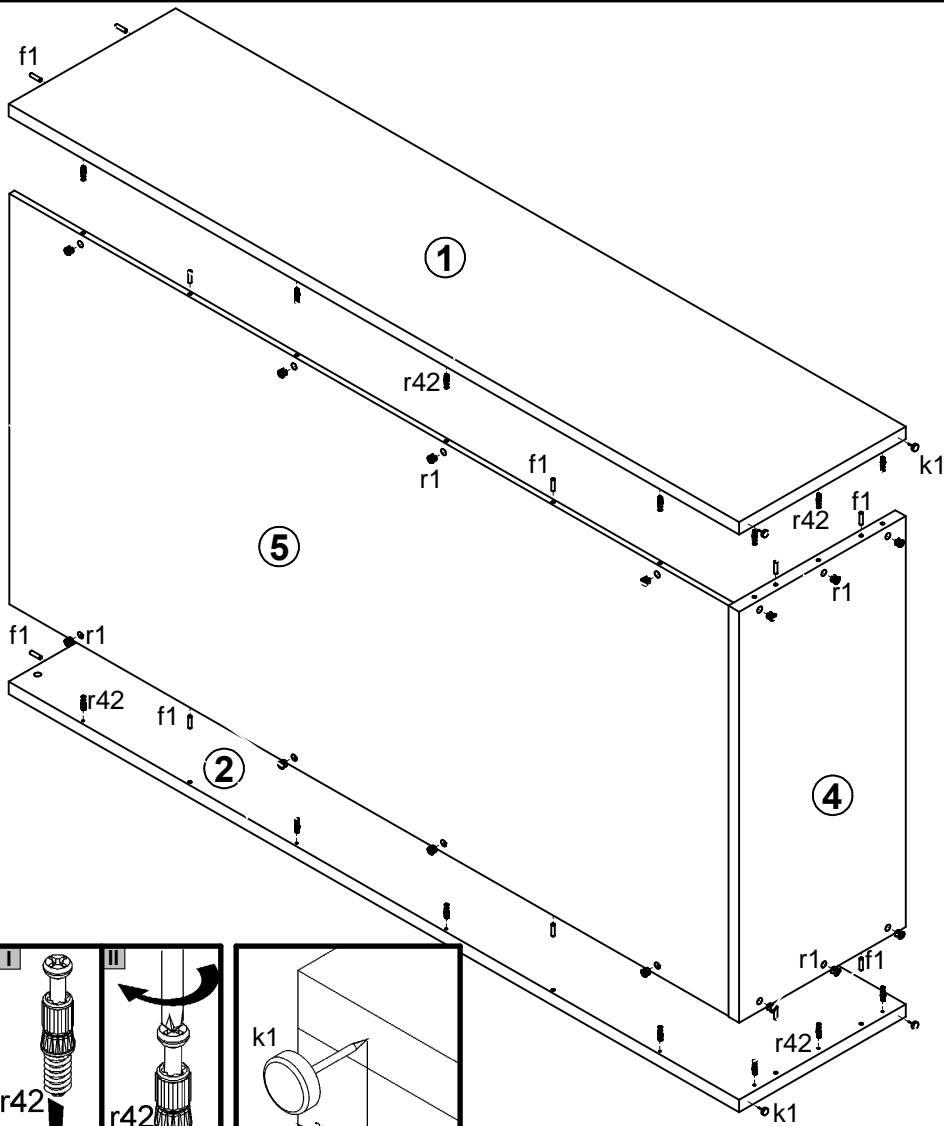

# 2

