

THE ASSEMBLY MANUAL

Attention: Before you start the assembly, please get acquainted with the entire assembly manual and stick to the order of assembly presented in this manual.

TOLEDO RANGE

Chest 4+2

Symbol elementu Značka dílu Element symbol Jel elemek Symbol elementu	Wymiary Rozměry Measurements Nagyság Rozmery	Kód Kód Code Kód Kód	Paczka Krabica Paket Csomagban Balik
1	954x152	S54-002	2/2
2	476x152	S54-003	2/2
3	476x152	S54-004	2/2
4	846x417	S54-103	1/2
5	846x417	S54-104	1/2
6	139x397	S54-105	1/2
7	960x447	S54-203	1/2
8	926x70	S54-403	2/2
9	320x100	S54-517	2/2
10	320x100	S54-518	2/2
11	895x100	S54-521	2/2
12	424x100	S54-522	2/2
13	906x320	S54-904	1/2
14	936x847	S54-906	1/2
15	435x320	S54-907	1/2

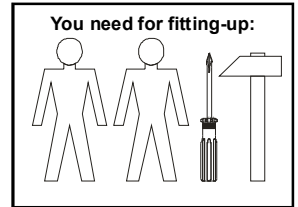
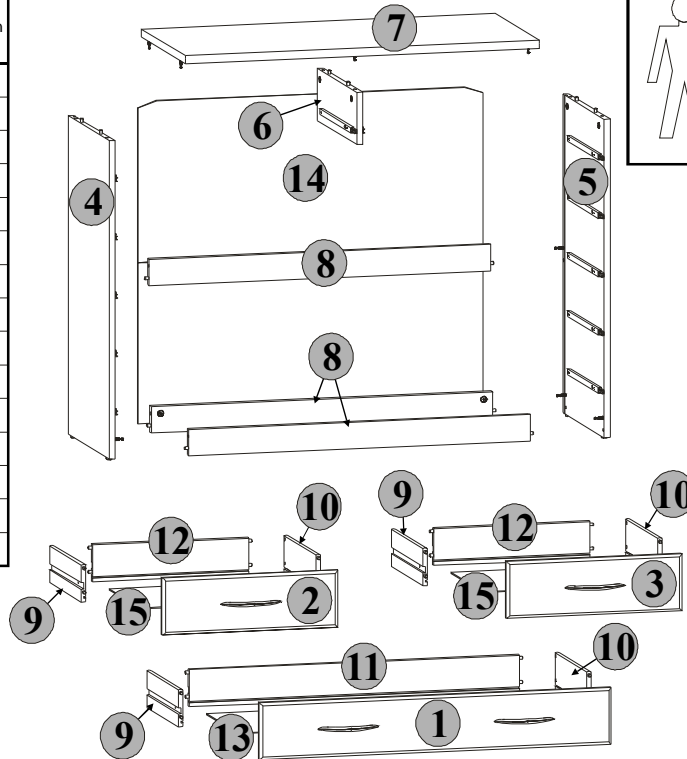

The symbols and the amount of accessories needed for the assembly have been presented below. The accessories can be found in the "Accessories" package.

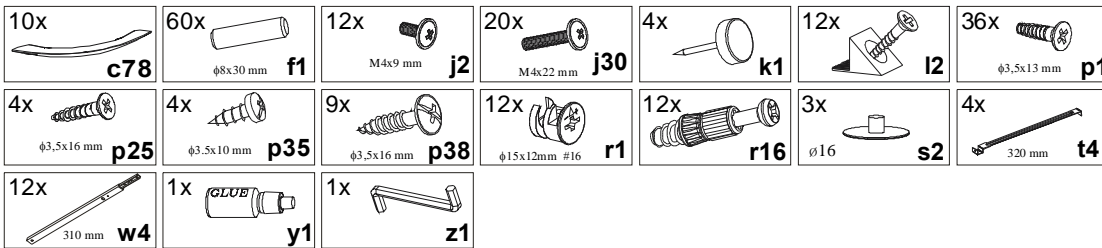
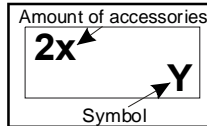

General instructions for furniture assembly

Attention

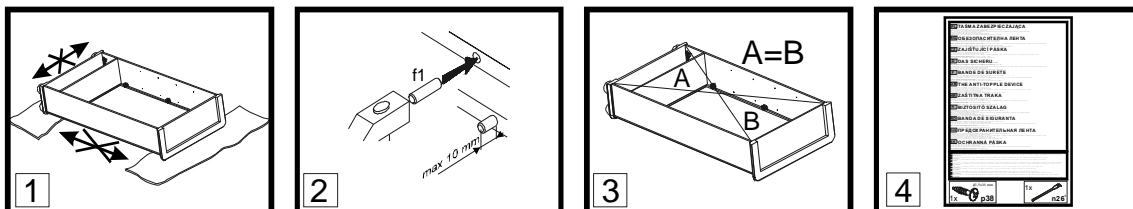

Attention:

- During the assembly, the elements should be put on a soft and clean surface, e.g. a towel or a blanket. Do not assemble the piece on a carpet or floor covering, etc.
- Drive *f1* pegs into the holes (8 mm in diameter) located along the edges of each element (leave the holes for the eccentric connector pivot free). **Attention:** In case a peg in one of the holes protrudes more than 10 mm, it should be hammered down, exchanged or shortened because it may cause damage to the side of the piece of furniture during its assembly.
- Before nailing a fiberboard, make sure that the diagonals are equal.
- The anti-topple device. When assembling the furniture follow the instructions in the manual. Improper fixing of the piece of furniture may cause it to topple when it is used.

INFORMATION!







Dear client, in case of complaining, please use the code number given in the assembly instruction. Any comments and complaints should be reported at the furniture purchase outlet. **Note!** Do not use any parts showing any faults or marks of damage.

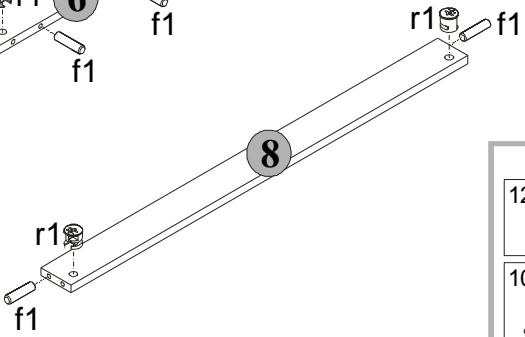
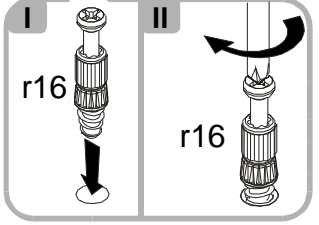
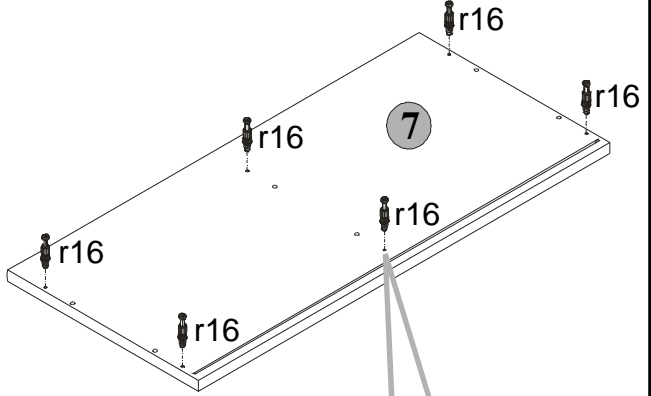
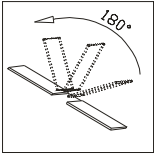
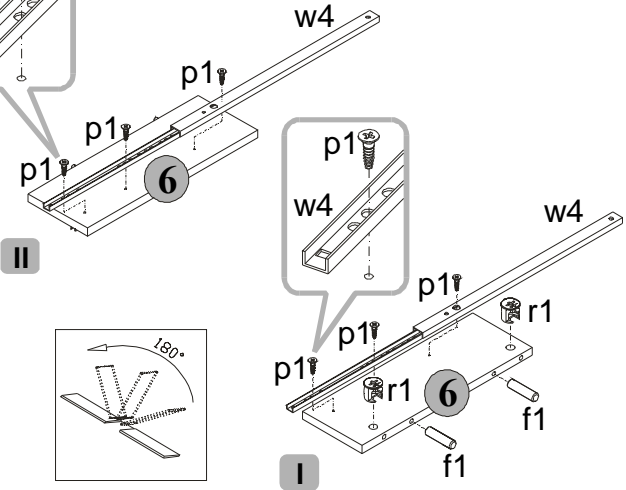
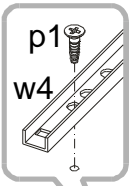
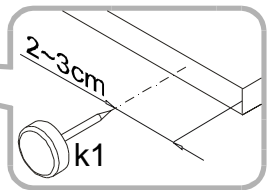
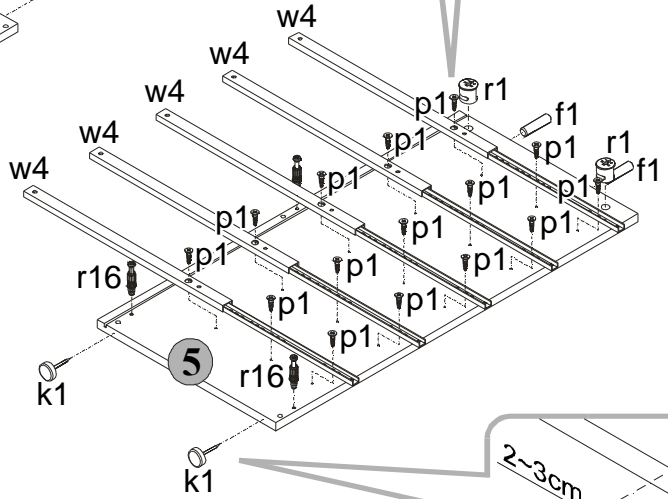
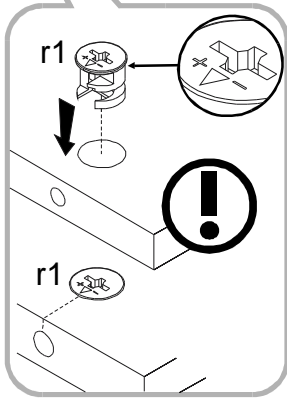
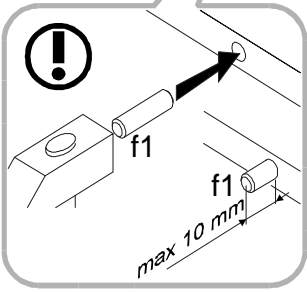
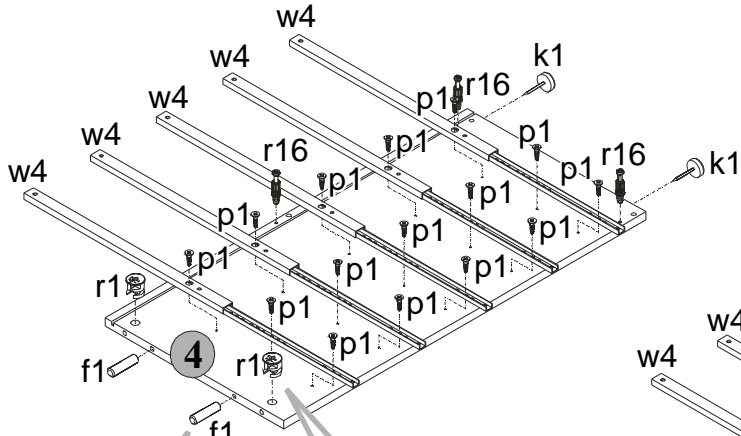
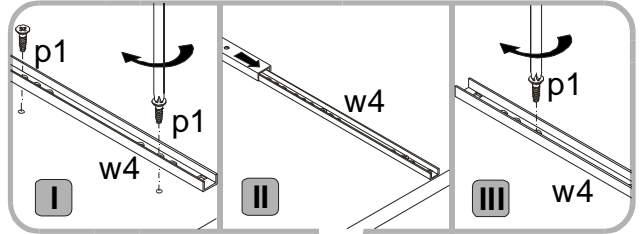

The first stage of the assembly is equipping the elements with the appropriate accessories according to the drawings below. The \odot symbols denote places to which special attention should be paid during the assembly.

1 TOL42C



You need for fitting-up:		
12x  $\phi 8 \times 30$ mm f1	4x  k1	36x  $\phi 3,5 \times 13$ mm p1
10x  $\phi 15 \times 12$ mm #16 r1	10x  r16	12x  310 mm w4



Assemble the unit as shown in the pictures using indicated connectors and/or joints.

2 TOL42C

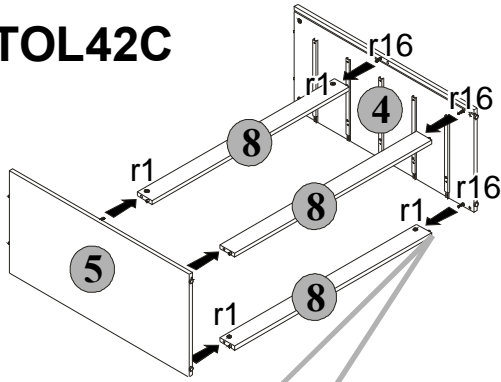

You need for fitting-up:

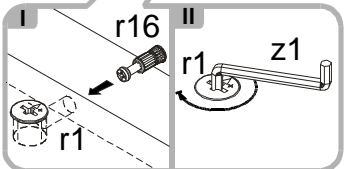

3 TOL42C

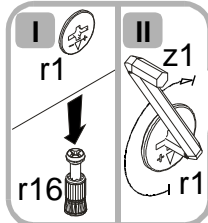
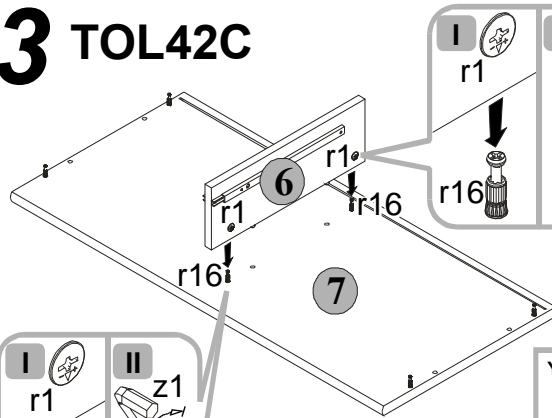

You need for fitting-up:

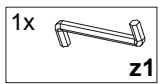

4 TOL42C

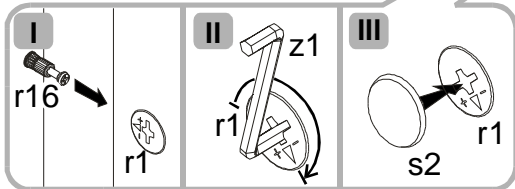
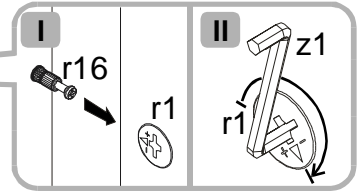
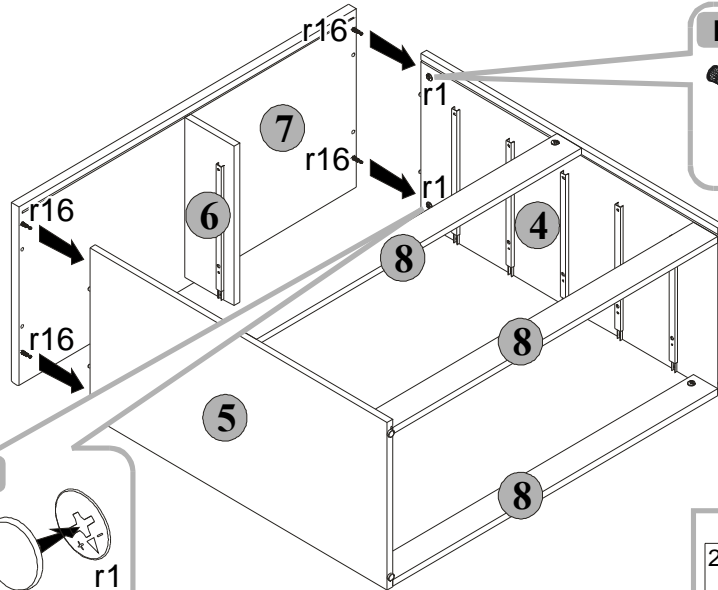

You need for fitting-up:

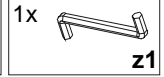

5 TOL42C

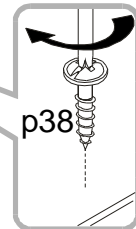
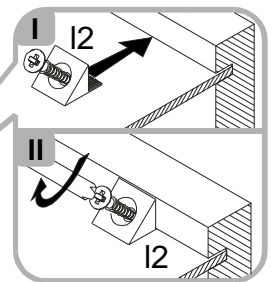
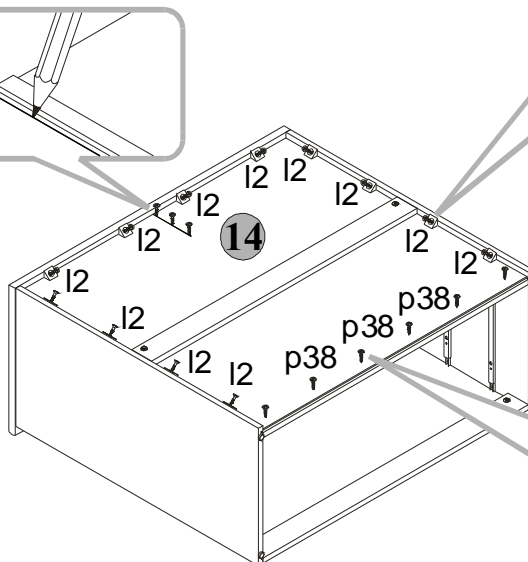
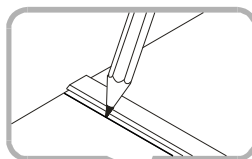
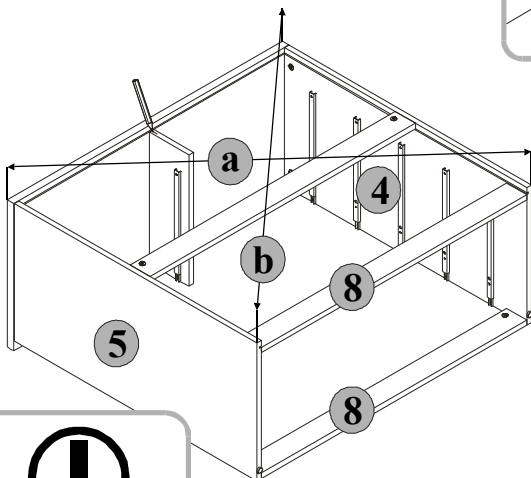

You need for fitting-up:

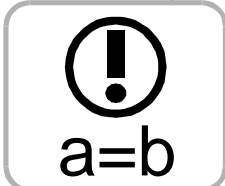
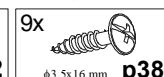

6 TOL42C

I

You need for fitting-up:

48x		1x	
	φ8x30 mm		y1

II

You need for fitting-up:

1x	
	y1

III

You need for fitting-up:

10x		20x		1x	
	c78		M4x22 mm		y1

IV

V

You need for fitting-up:

4x		4x		4x	
	φ3.5x16 mm		φ3.5x10 mm		320 mm

7 TOL42C

You need for fitting-up:

12x	
	M4x9 mm
	j2