

THE ASSEMBLY MANUAL

Attention: Before you start the assembly, please get acquainted with the entire assembly manual and stick to the order of assembly presented in this manual.

TOLEDO RANGE

Chest 5s

Element symbol	Measurements	Code	Paket
1	474x152	S44-016	1/1
2	846x417	S44-103	1/1
3	846x417	S44-104	1/1
4	480x447	S44-201	1/1
5	446x70	S44-401	1/1
6	320x100	S44-517	1/1
7	320x100	S44-518	1/1
8	415x100	S44-519	1/1
9	425x320	S44-902	1/1
10	852x456	S44-903	1/1

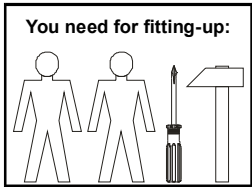
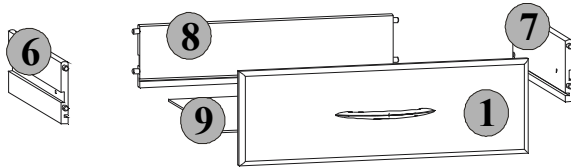
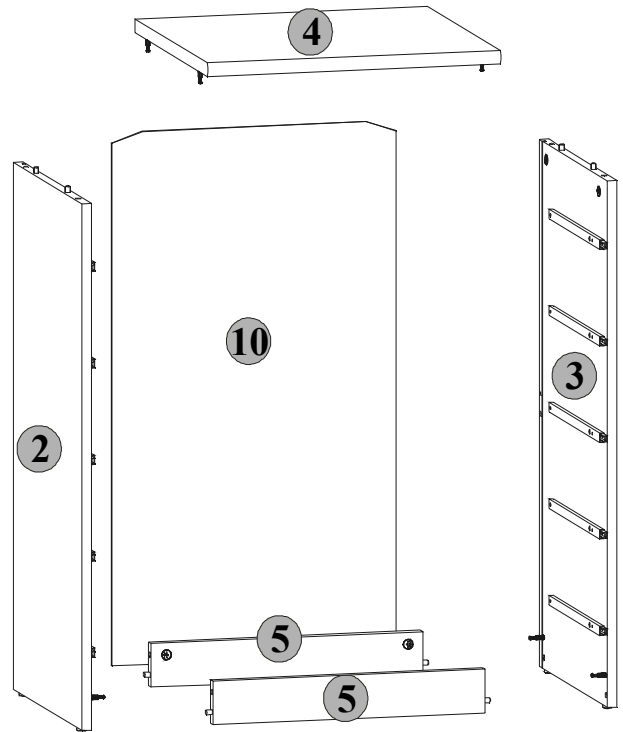

The symbols and the amount of accessories needed for the assembly have been presented below. The accessories can be found in the "Accessories" package.

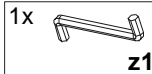
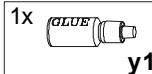
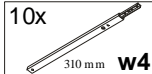
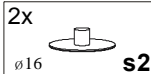
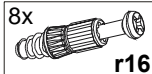
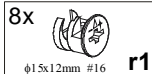
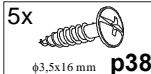
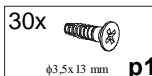
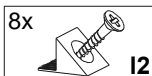
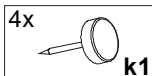
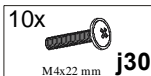
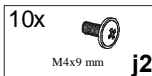
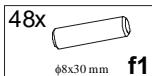
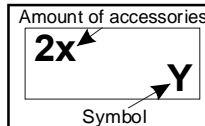

<input type="checkbox"/>	TASMA ZABEZPEČAČA
<input type="checkbox"/>	ОБЕЗОПАСИТЕЛНА ЛЕНТА
<input type="checkbox"/>	ZAJISTUJICI PASKA
<input type="checkbox"/>	DAS SICHERU
<input type="checkbox"/>	BANDE DE SURETE
<input type="checkbox"/>	THE ANTI-TOPPLE DEVICE
<input type="checkbox"/>	ZASTITNA TRAKA
<input type="checkbox"/>	BIZTOSITO SZALAG
<input type="checkbox"/>	BANDA DE SIGURANTA
<input type="checkbox"/>	ПРЕДОХРАНИТЕЛНА ЛЕНТА
<input type="checkbox"/>	OCHRANNA PASKA

<input type="checkbox"/>	φ3.5x16 mm	1x
<input type="checkbox"/>	n26	1x

General instructions for furniture assembly

Attention

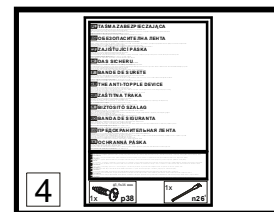
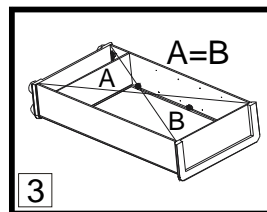
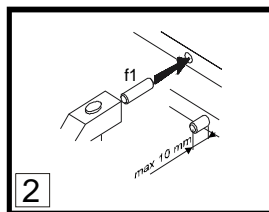
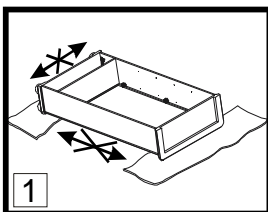

Attention:

1. During the assembly, the elements should be put on a soft and clean surface, e.g. a towel or a blanket. Do not assemble the piece on a carpet or floor covering, etc.
 2. Drive f1 pegs into the holes (8 mm in diameter) located along the edges of each element (leave the holes for the eccentric connector pivot free). **Attention:** In case a peg in one of the holes protrudes more than 10 mm, it should be hammered down, exchanged or shortened because it may cause damage to the side of the piece of furniture during its assembly.

3. Before nailing a fiberboard, make sure that the diagonals are equal.

4. The anti-topple device. When assembling the furniture follow the instructions in the manual. Improper fixing of the piece of furniture may cause it to topple when it is used.

INFORMATION!

Dear client, in case of complaining, please use the code number given in the assembly instruction. Any comments and complaints should be reported at the furniture purchase outlet. **Note!** Do not use any parts showing any faults or marks of damage.



The first stage of the assembly is equipping the elements with the appropriate accessories according to the drawings below. The \odot symbols denote places to which special attention should be paid during the assembly.

1 Chest 5s

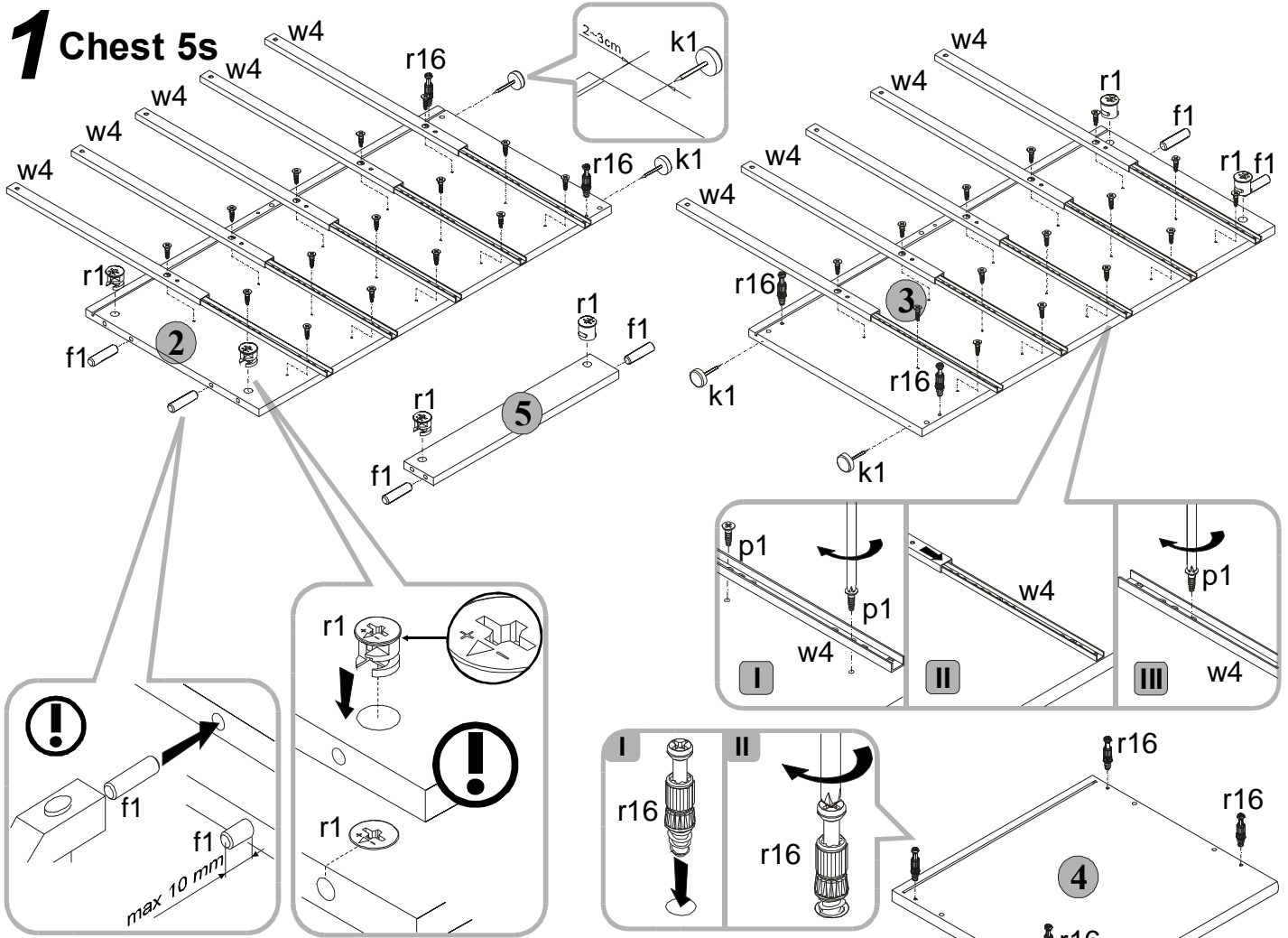

You need for fitting-up:

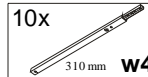
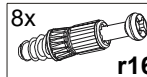
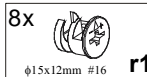
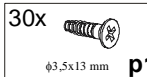
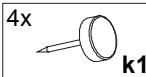
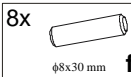

Assemble the unit as shown in the pictures using indicated connectors and/or joints.

2 Chest 5s

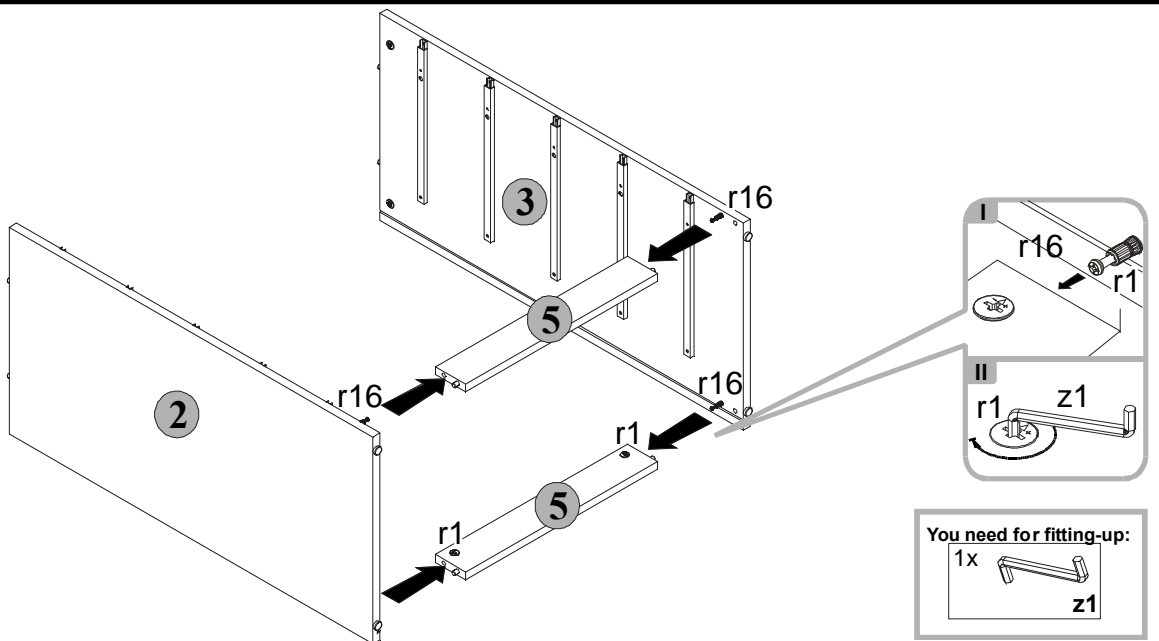

You need for fitting-up:
1x z1

3 Chest 5s

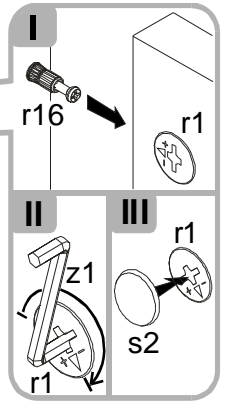
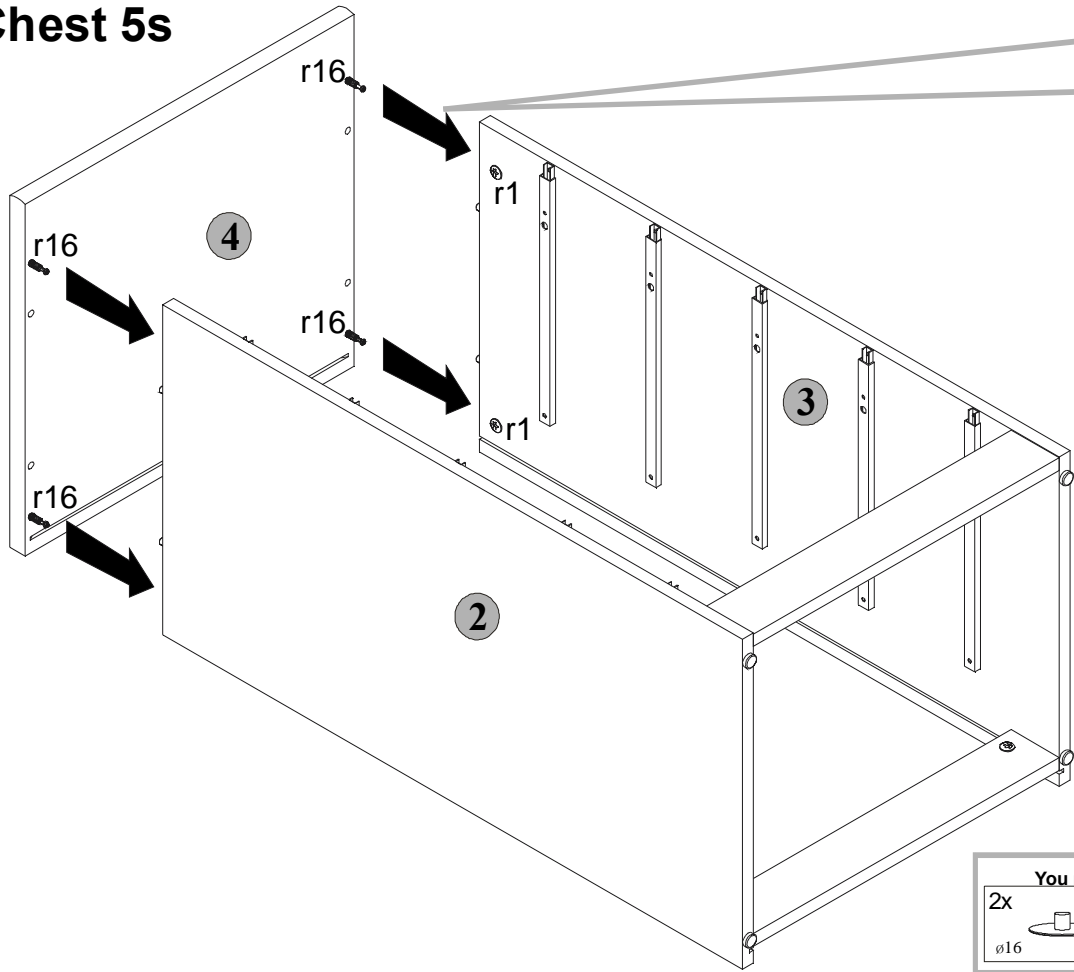

You need for fitting-up:

2x ø16	s2	1x	z1
-----------	----	----	----

4 Chest 5s

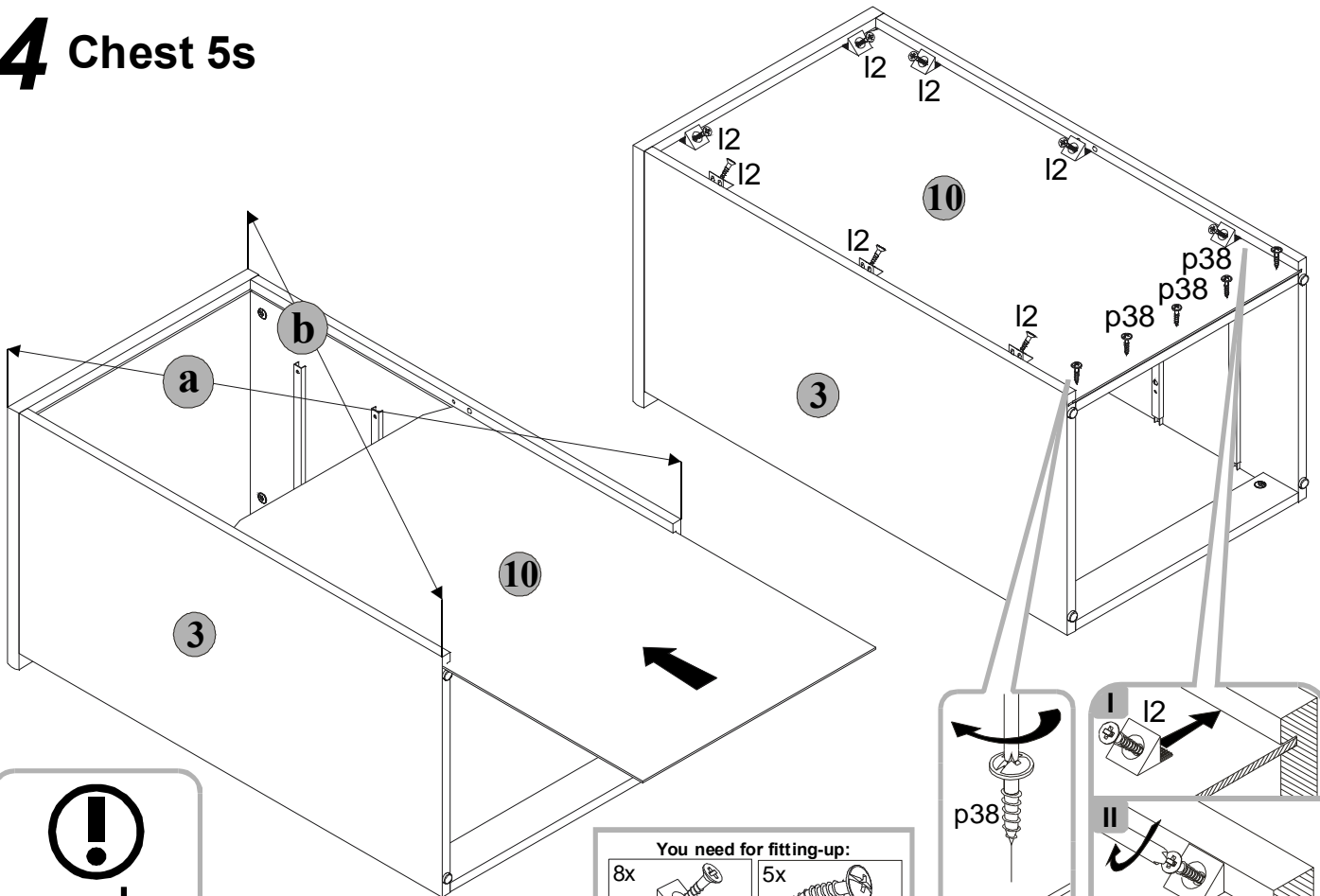

a=b

You need for fitting-up:

8x	l2	5x	p38 φ3,5x16 mm
----	----	----	-------------------

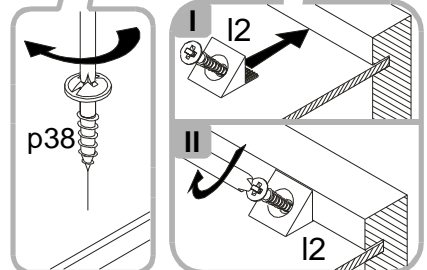

5 Chest 5s

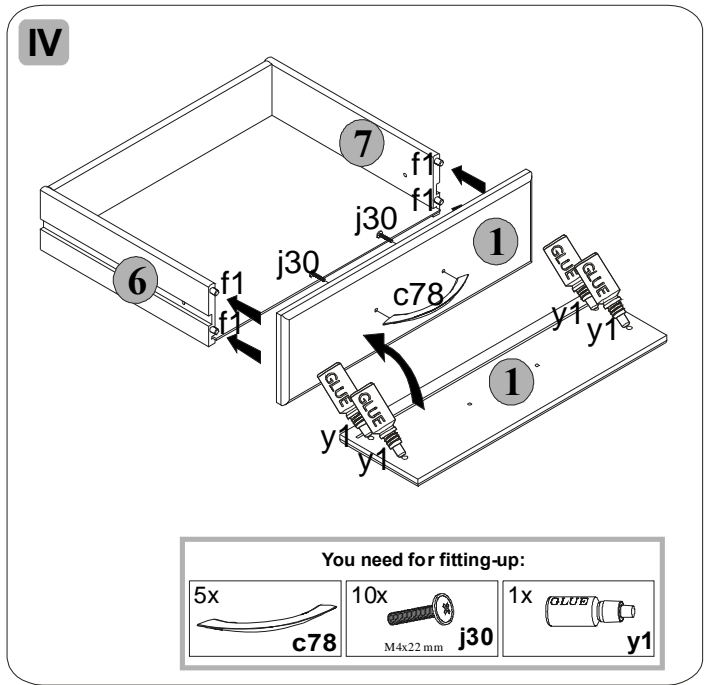
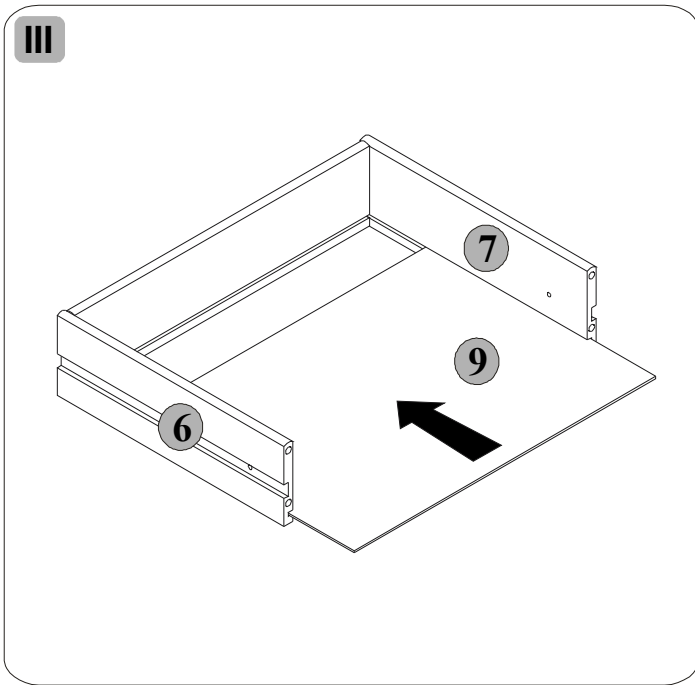
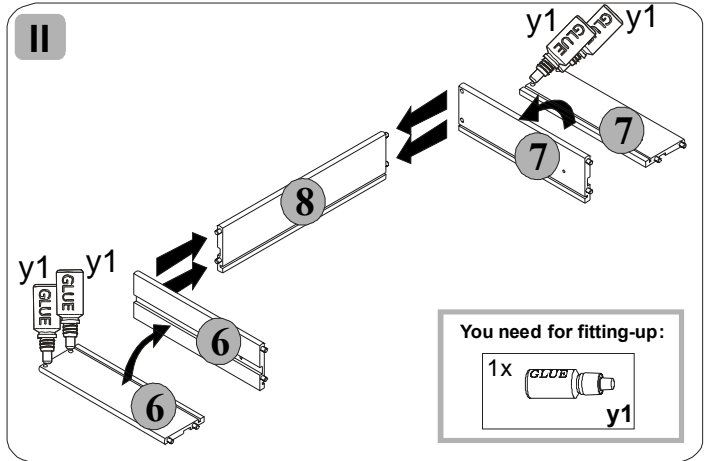
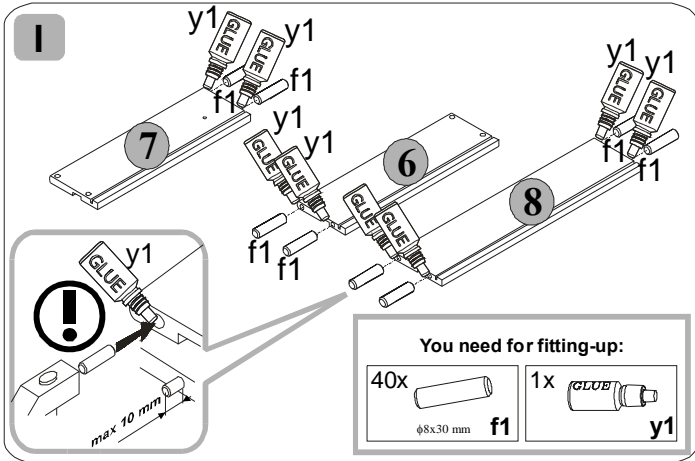

6 Chest 5s

