

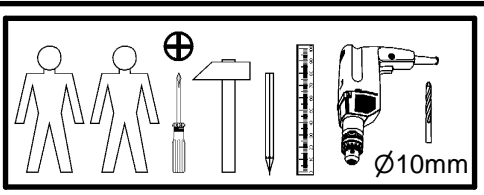

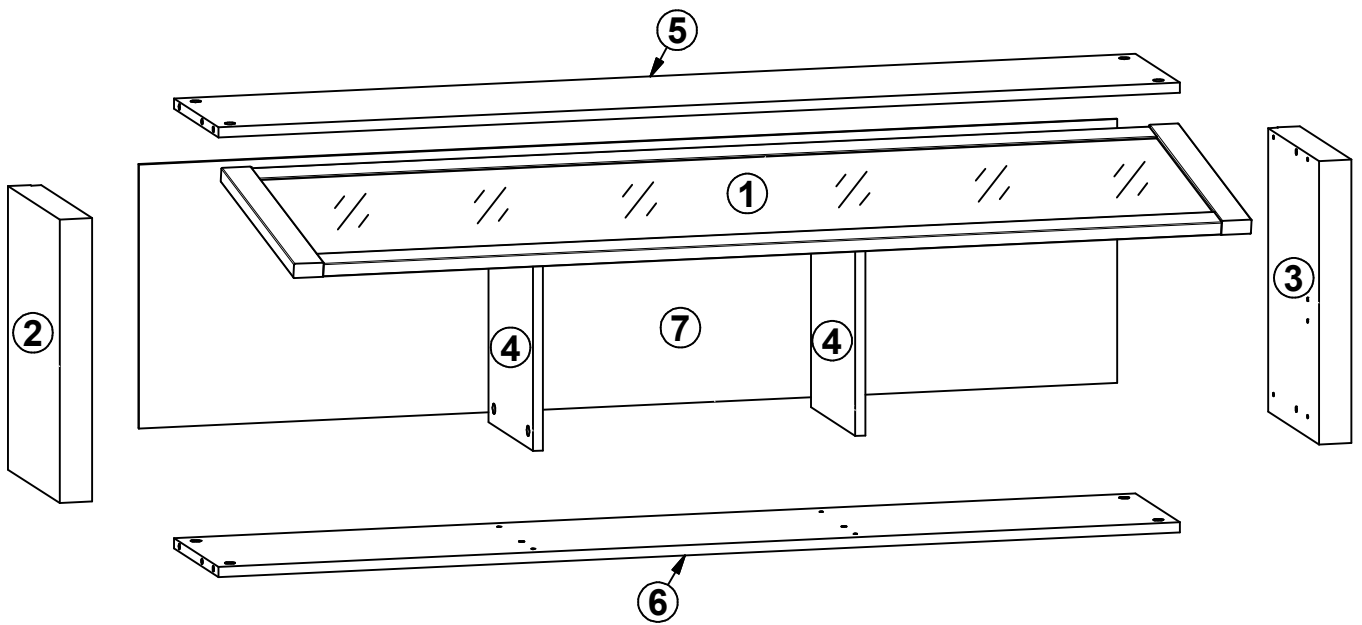







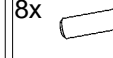
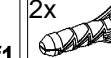
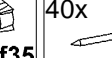
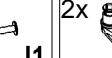
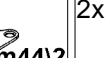
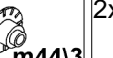

VENOM MIX

S192-SFW1K

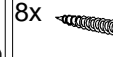
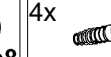
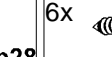
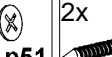
A	B	C		D
1	S192-012	1444	416	3/3
2	S139-111	420	290	1/3
3	S139-112	420	290	1/3
4	S139-113	366	250	2/3
5	S139-308	1450	250	2/3
6	S139-309	1450	250	2/3
7	S139-908	1475	391	3/3

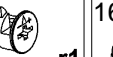

3x  a102	3x  b45	4x  Ø6.3x13 mm e5	8x  Ø8x30 mm f1	2x  Ø10x50 mm f35	40x  l1	2x  m44\2	2x  m44\3	2x  m44\4
1x  m44\6	2x  m44\7	2x  n150	8x  Ø4x25 mm p8	4x  Ø4x13 mm p28	6x  Ø3.5x15 mm p51	2x  Ø6x60 mm p75	16x  Ø15x12 mm #16 r1	16x  r42
16x  Ø16 s2								

1

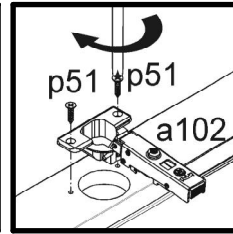
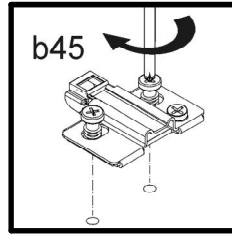
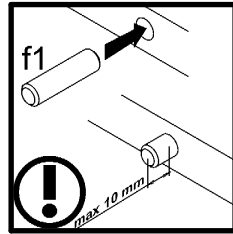
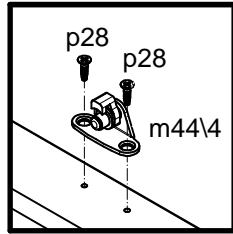
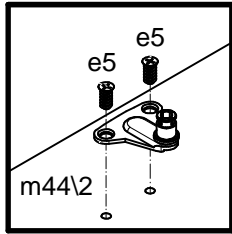
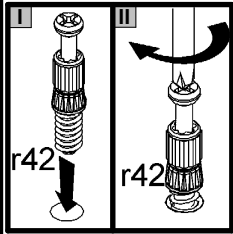
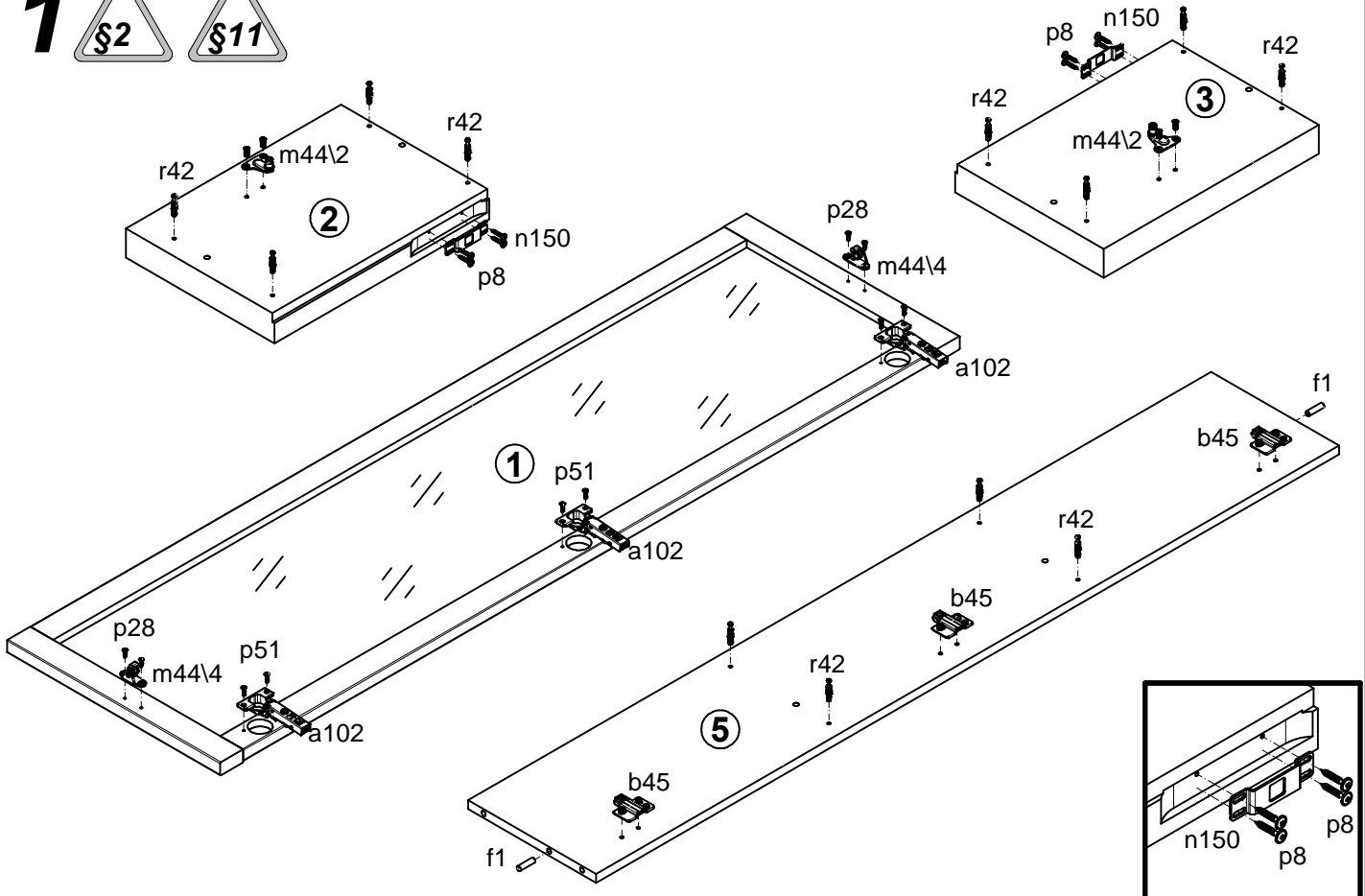

2

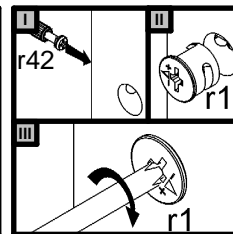
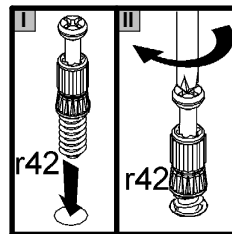
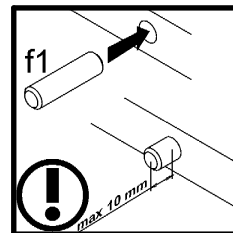
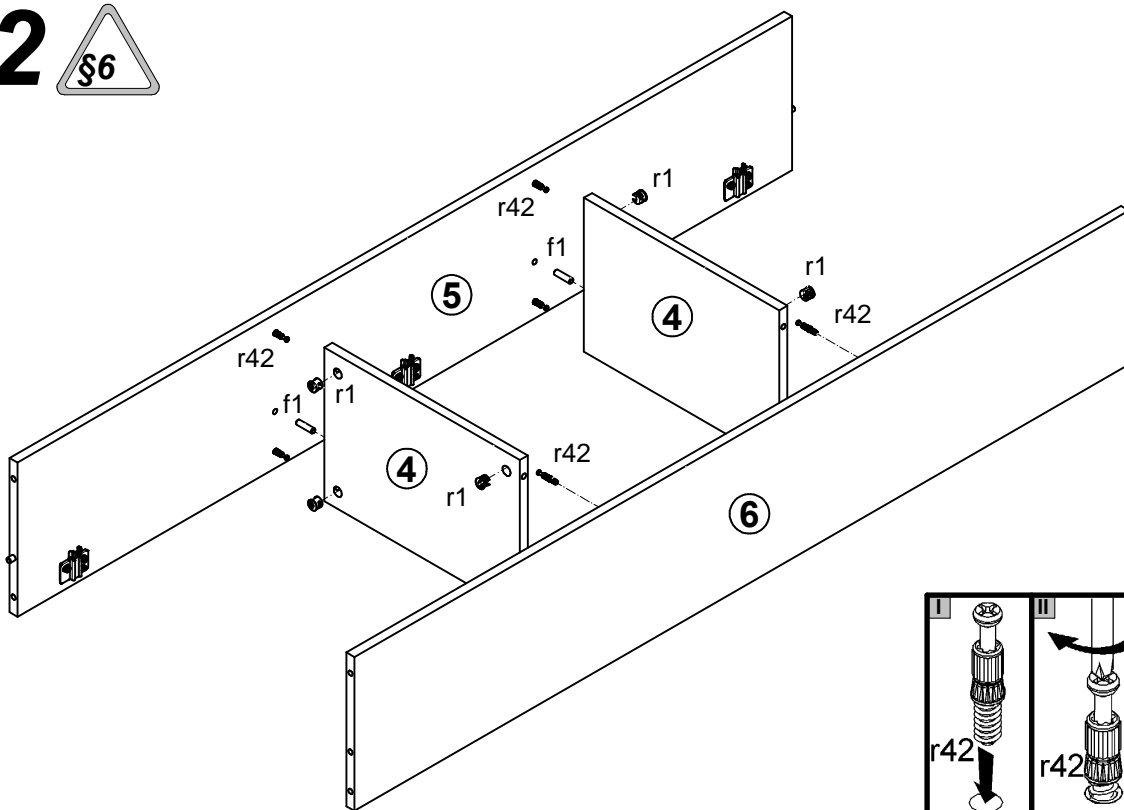

3

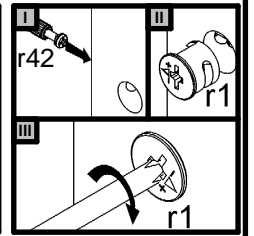
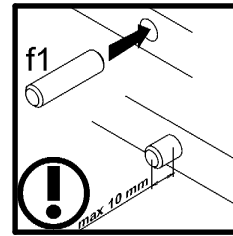
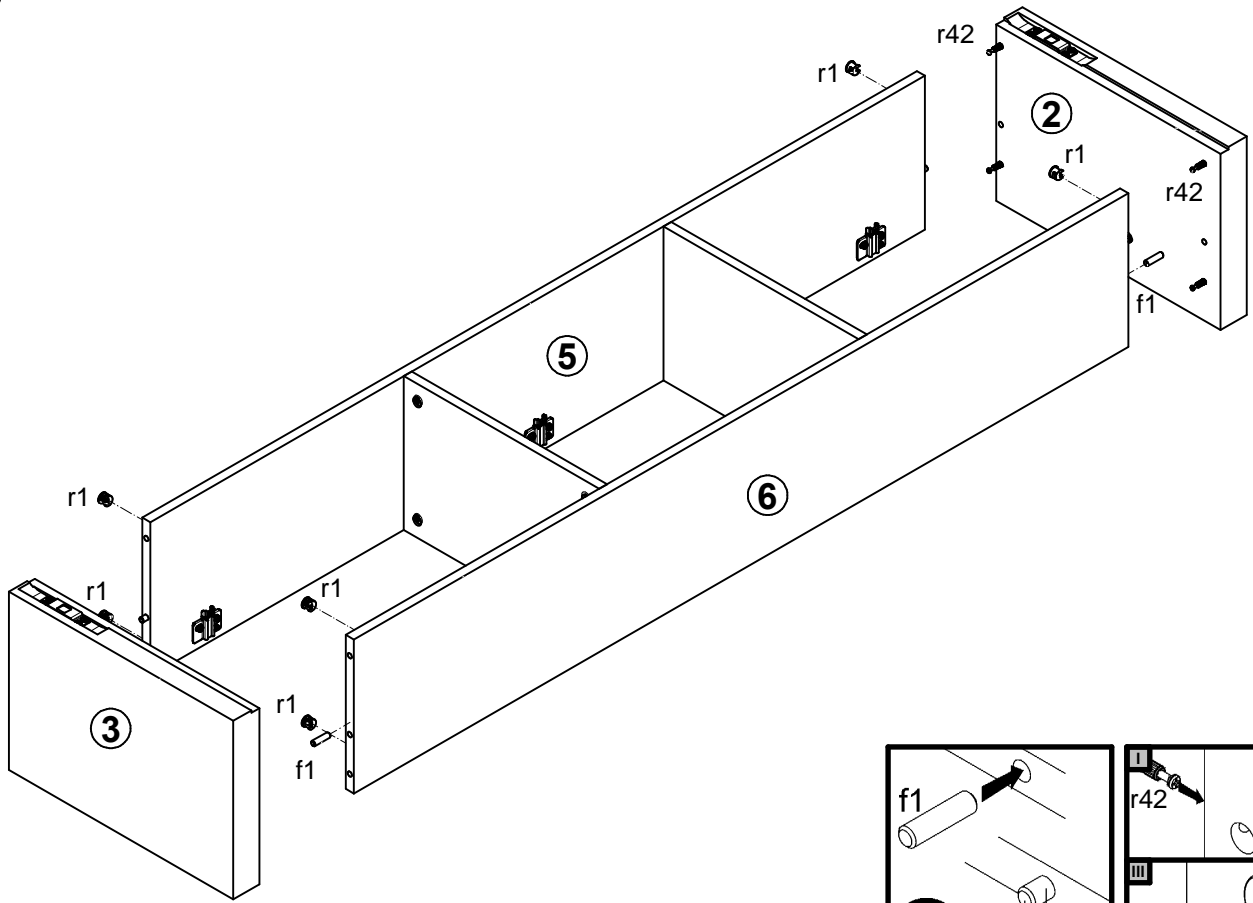

4

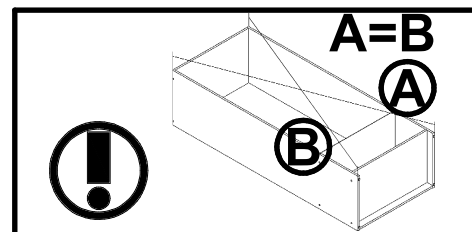
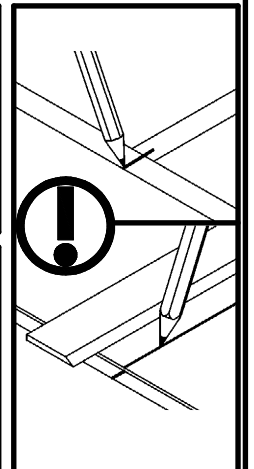
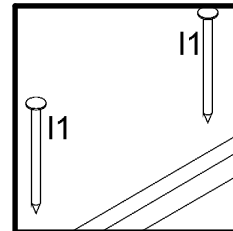
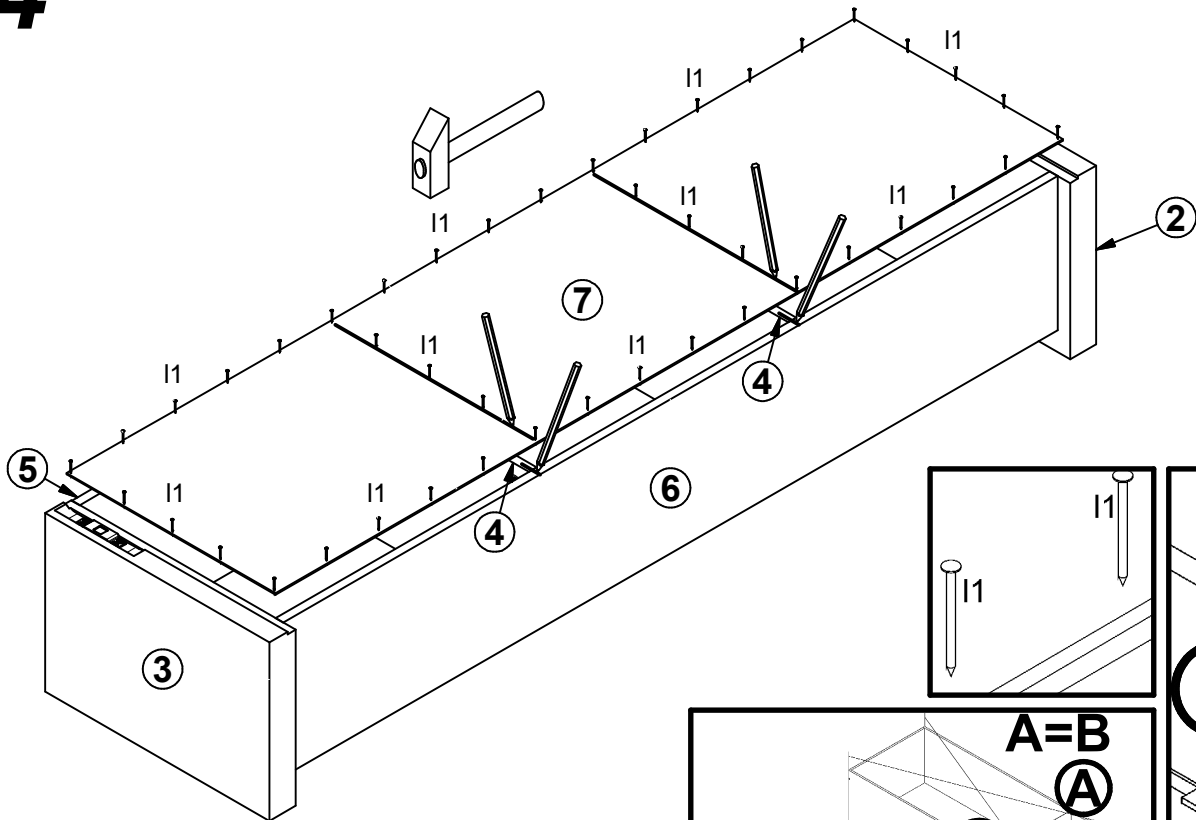

5

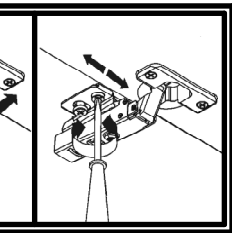
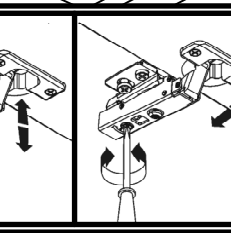
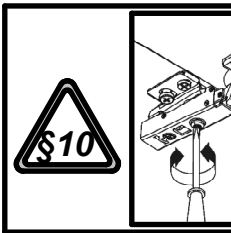
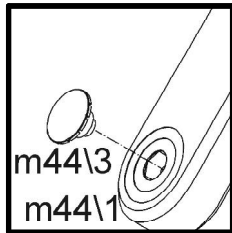
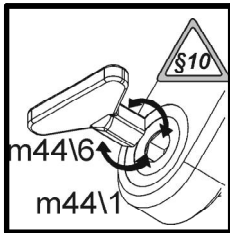
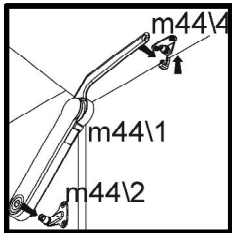
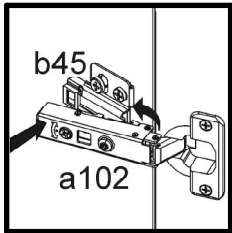
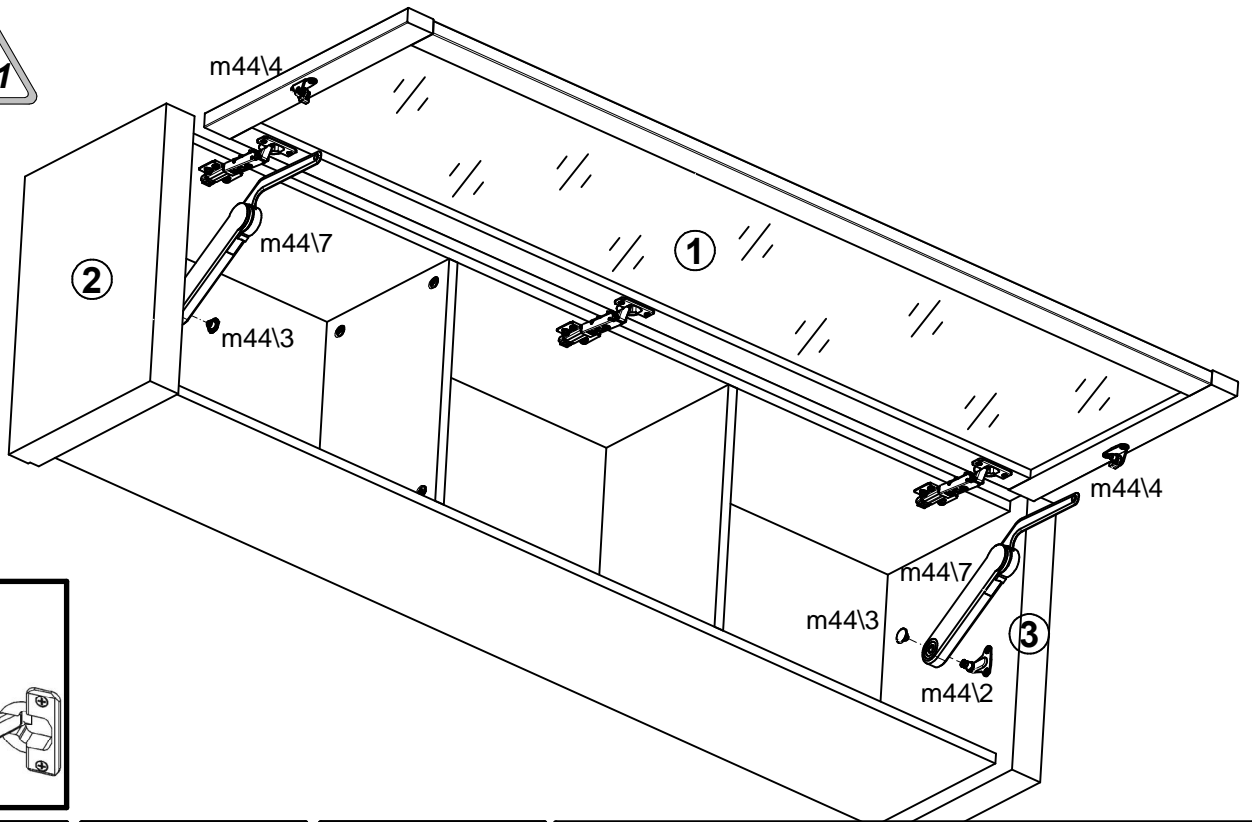

6

