

FAMILY LINE

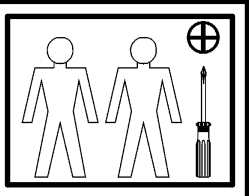
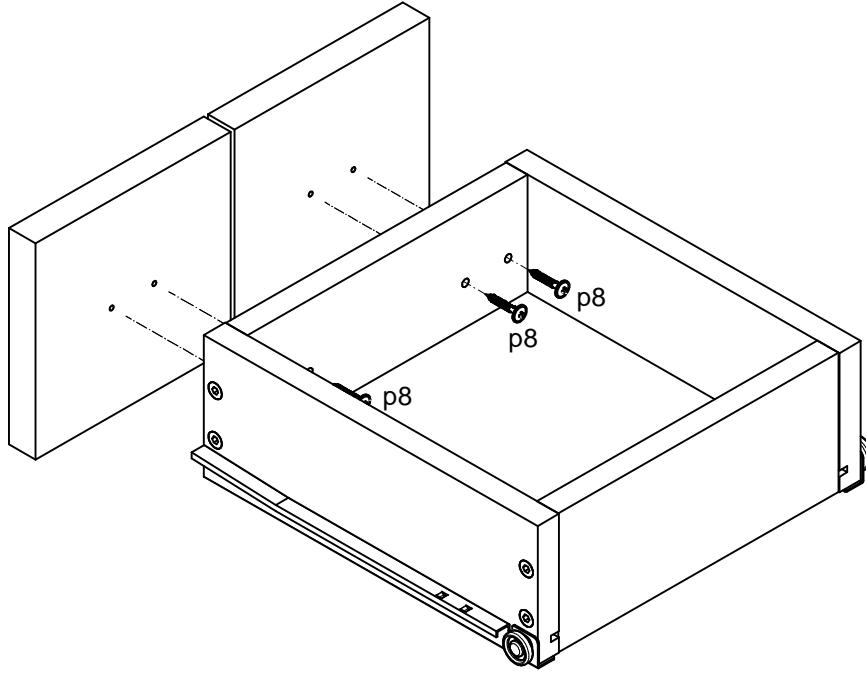

1 / 1

P28-K10-MONT_FRN_NR_09-M_IN7-KOR01.idw

FAMILY LINE

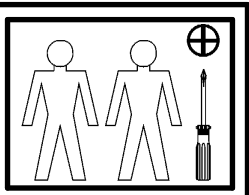
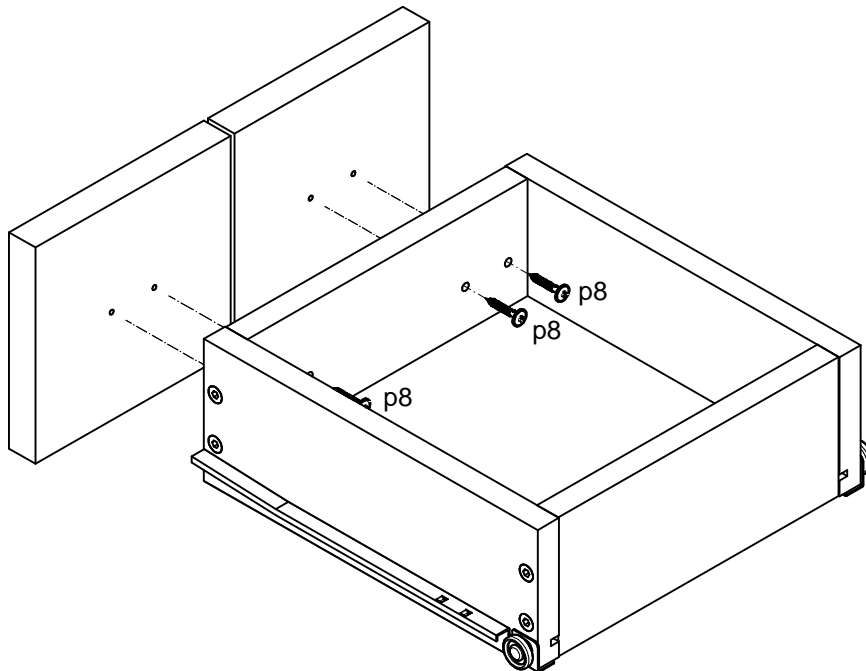

1 / 1

P28-K10-MONT_FRN_NR_09-M_IN7-KOR01.idw