

FAMILY LINE

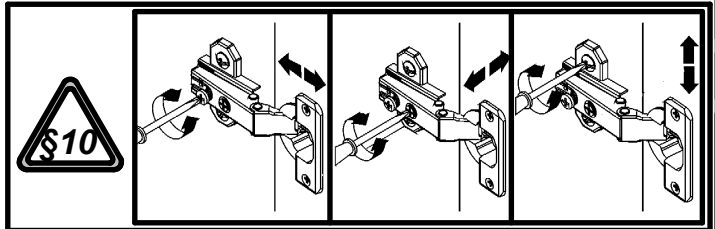

FAMILY LINE

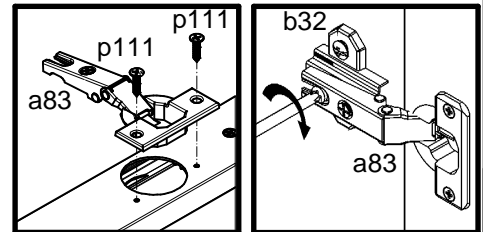
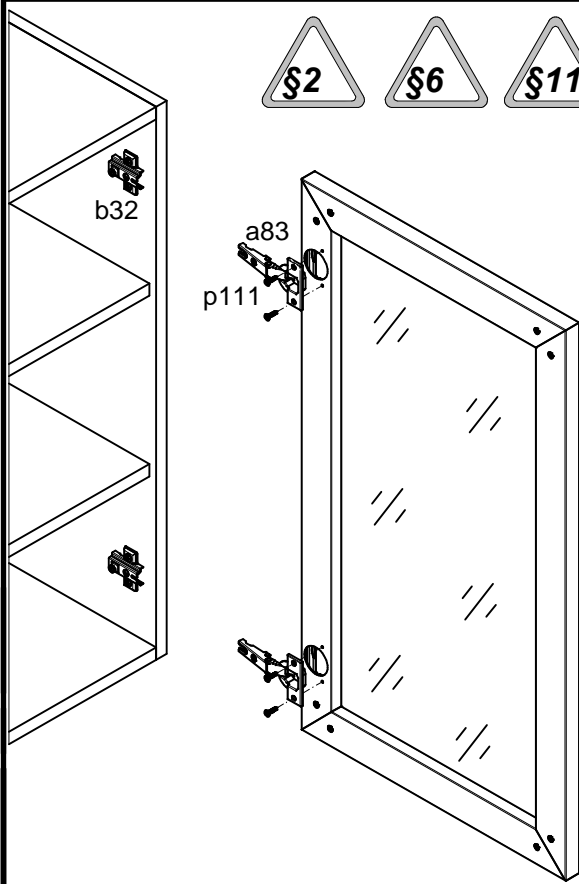
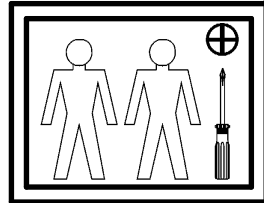
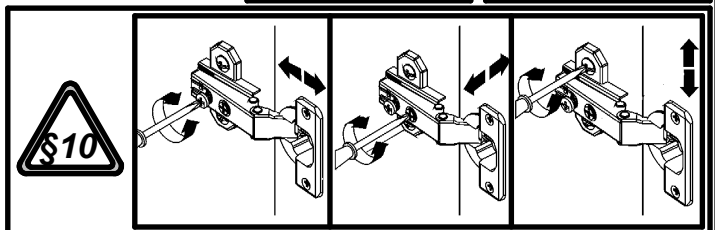
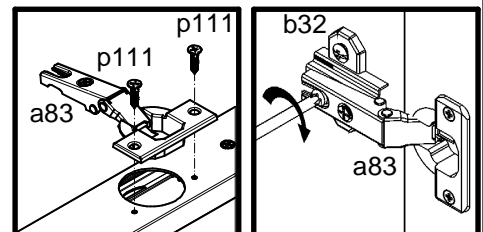
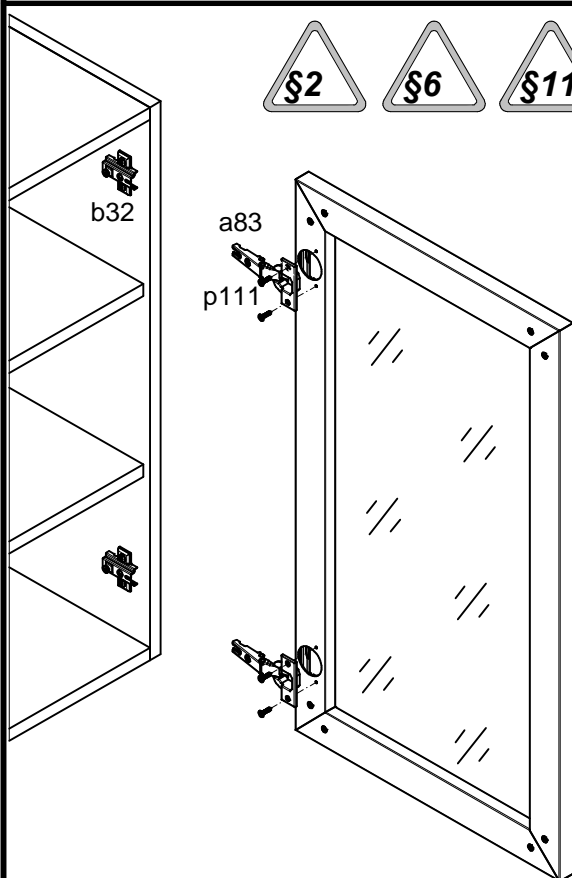
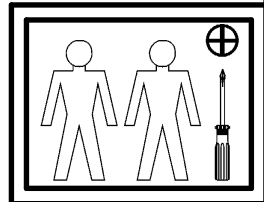

FAMILY LINE

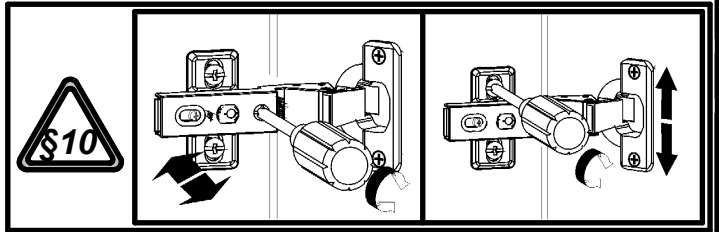
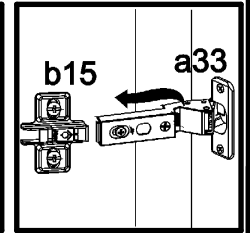
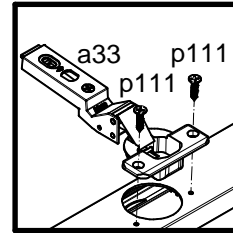
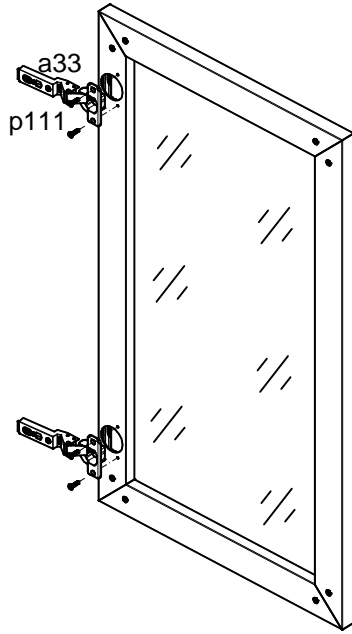
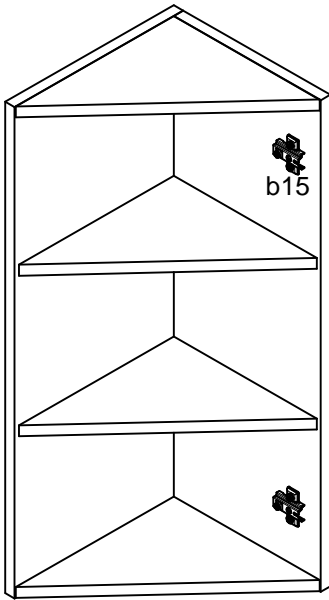
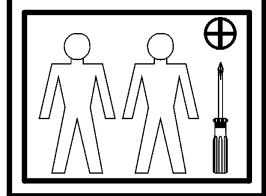

2 / 2

P28-K10-MONT_FRN_NR_15-M_IN7-KOR01.idw

FAMILY LINE

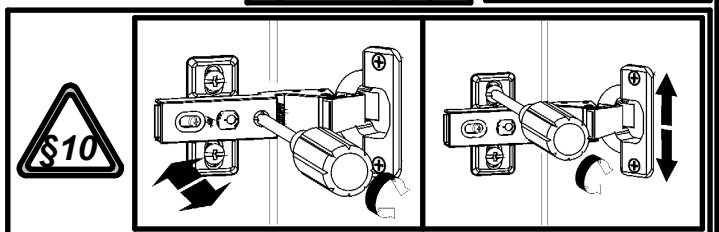
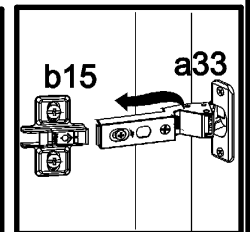
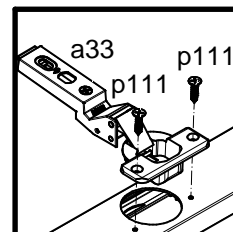
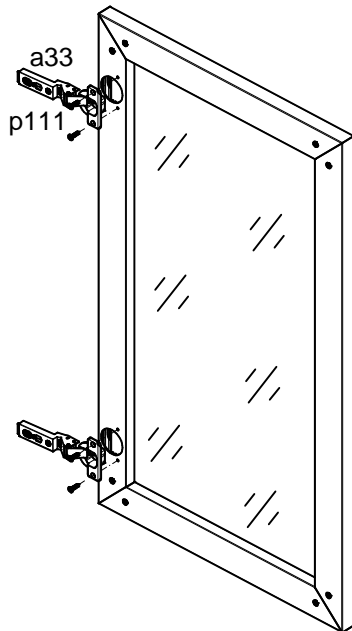
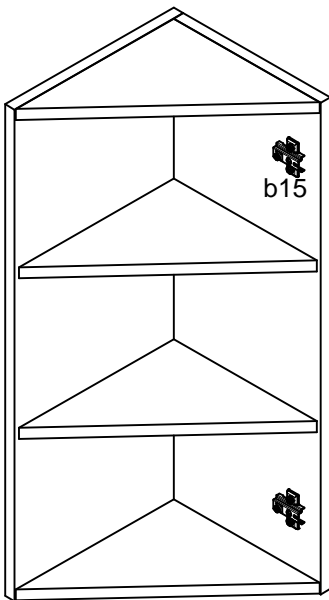
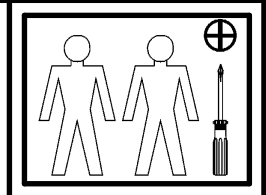

2 / 2

P28-K10-MONT_FRN_NR_15-M_IN7-KOR01.idw