

Junona Line

K22-G2W/80/57 Moduł A , A + A1

A	B	C	D
K22-G2W/80/57			
1	K22-120	573	285 1/2
2	K22-328	769	285 1/2
3	K22-329	768	260 1/2
4	K22-919	567	793 1/2
Moduł A , A + A1			
1	K22-120	573	285 2/3
2	K22-328	769	285 2/3
3	K22-329	768	260 2/3
4	K22-919	567	793 2/3

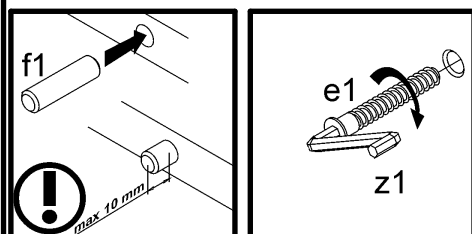
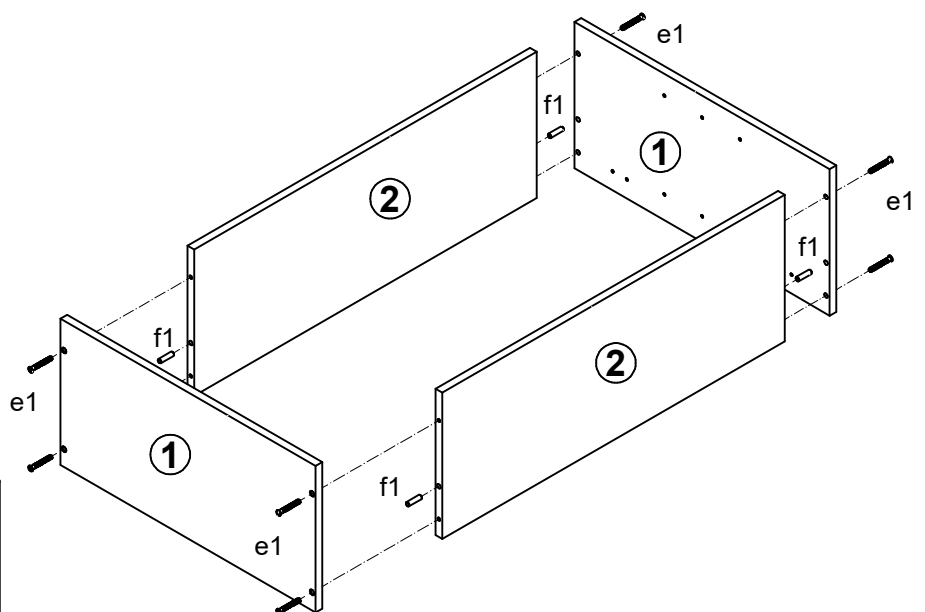
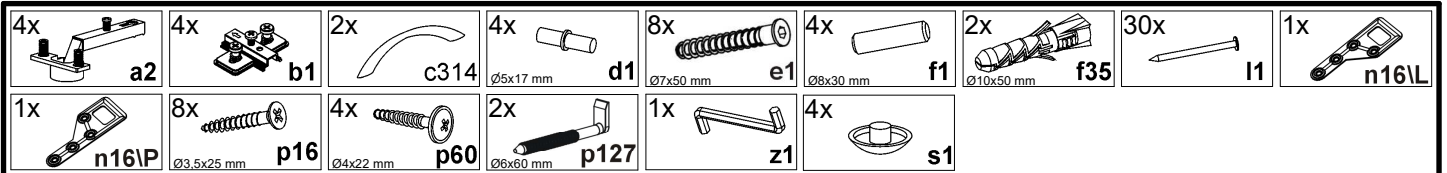
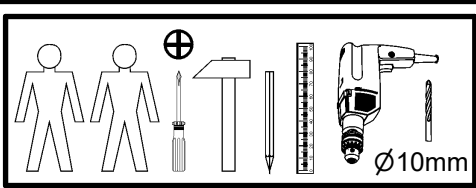
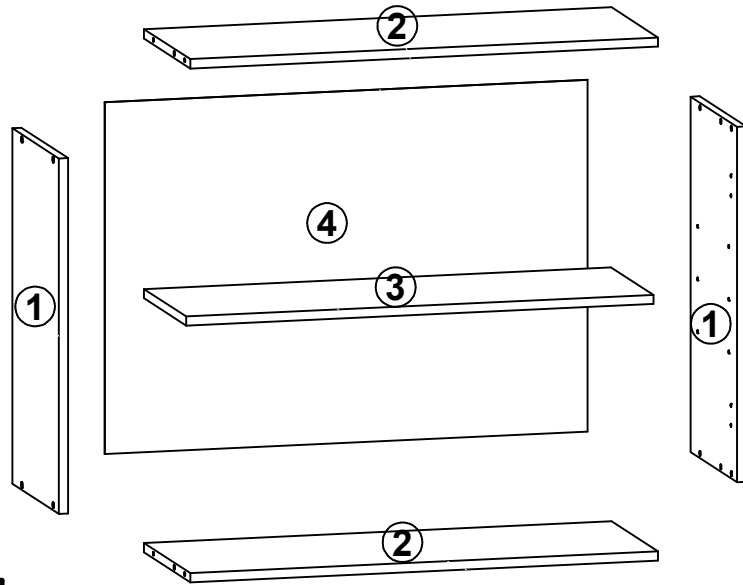
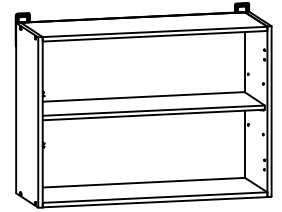

2 §6

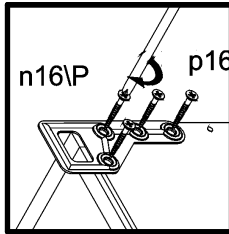
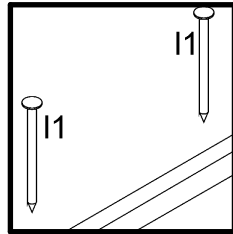
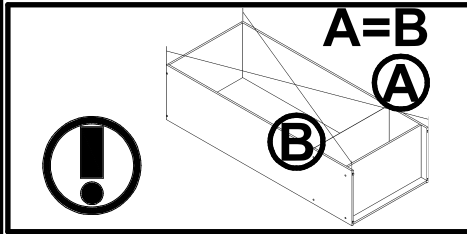
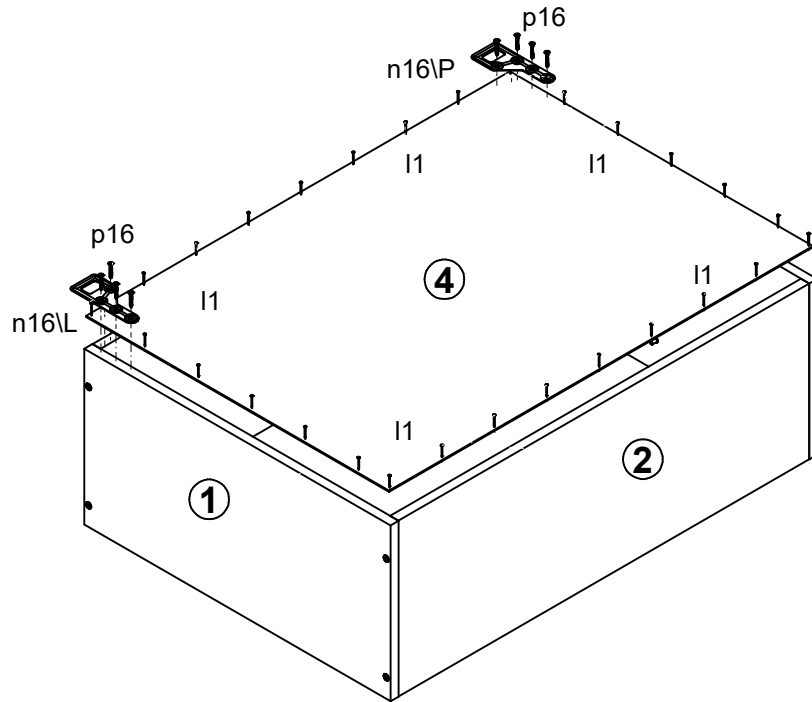

3

