

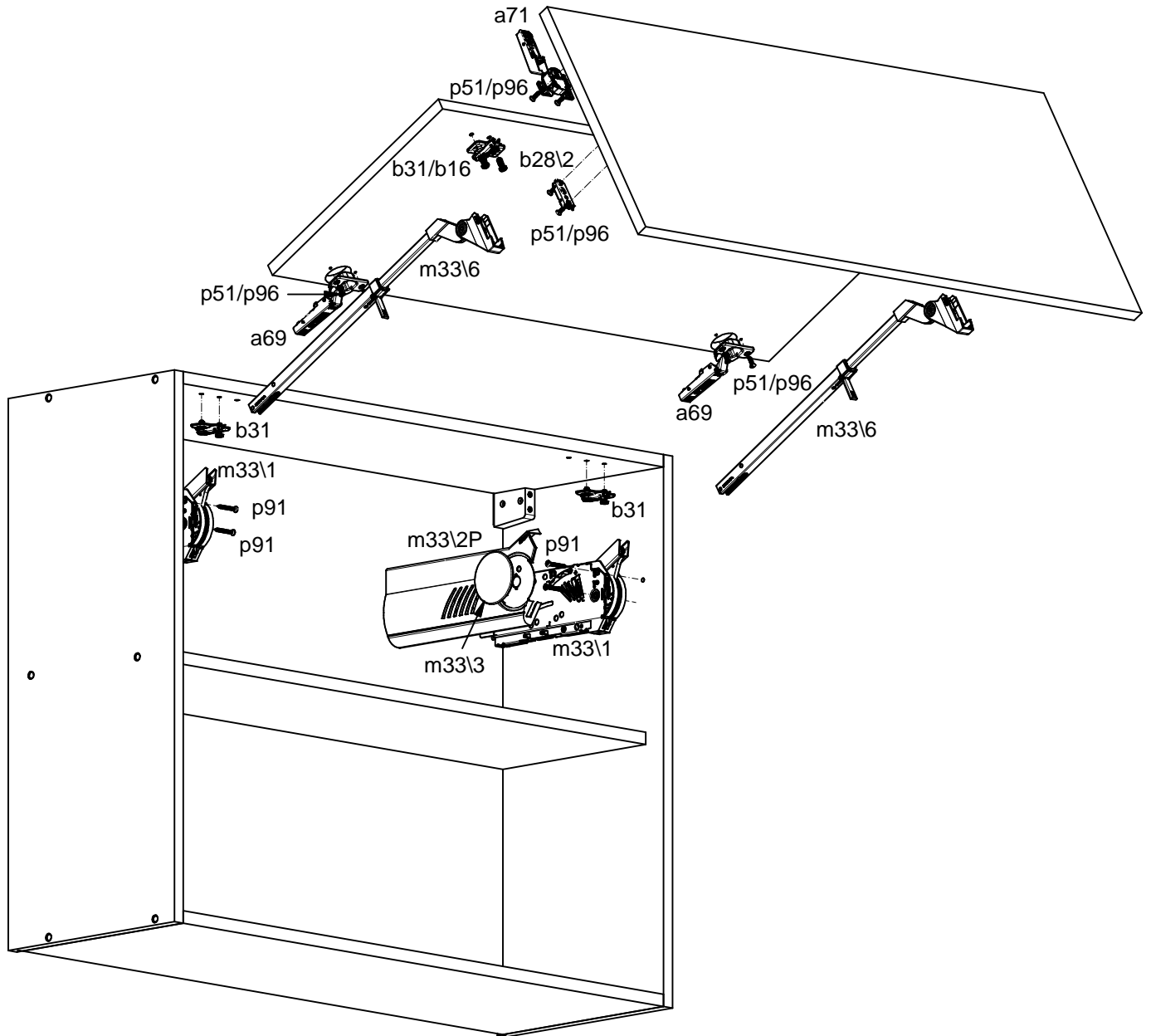

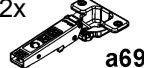

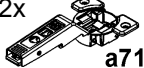









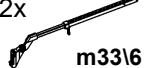

## fronty płyta / aluminium szerokie

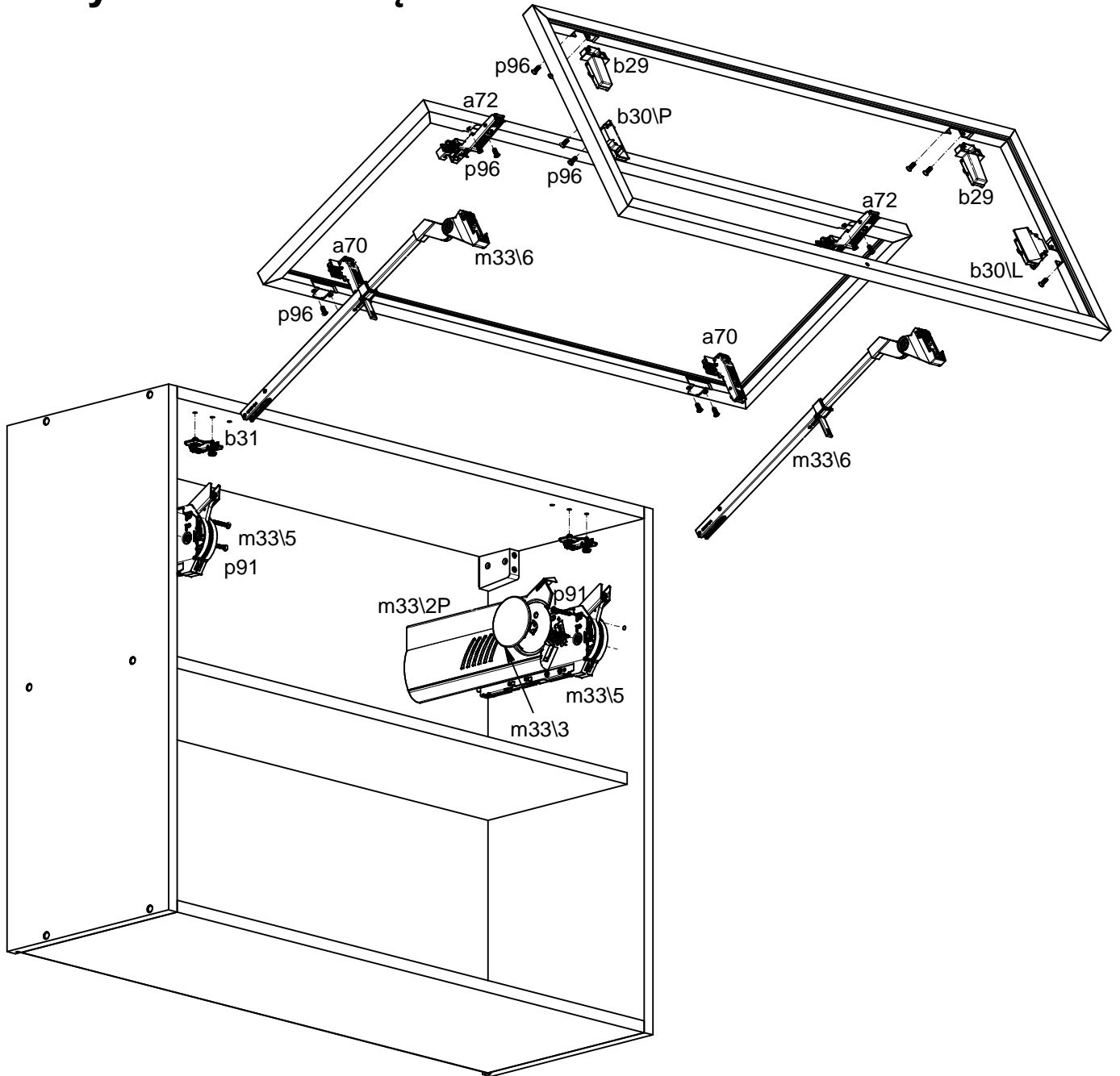

2x  a69	2x  a71	2x  b28\2	2x  m33\1	1x  m33\2L	1x  m33\2P	2x  m33\3	2x  m33\6	10x  Ø4x34 mm p91
4x  b31	płyta aluminium	2x  b16	12x  Ø3,5x15 mm p51	płyta aluminium	16x  Ø3,5x11 mm p96			

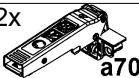
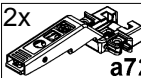
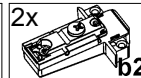
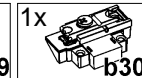
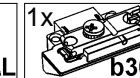
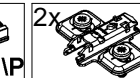
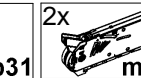
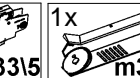
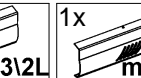
## fronty aluminium wąskie

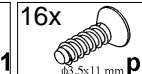

2x  a70	2x  a72	2x  b29	1x  b30\ L	1x  b30\ P	2x  b31	2x  m33\ 5	1x  m33\ 2L	1x  m33\ 2P
2x  m33\ 3	2x  m33\ 6	10x  p91 <small>φ4x34 mm</small>	16x  p96 <small>φ3.5x11 mm</small>					