

# SPK

GO2/5-90/72

A	B	C	D	
1	QS1-1136/A	716	300	1/1
2	QS1-2127/A	716	300	1/1
3	QS1-362	867	290	1/1
4	QS1-363	867	280	1/1
5	QS1-392/A	867	290	1/1
6	QS1-944	877	713	1/1

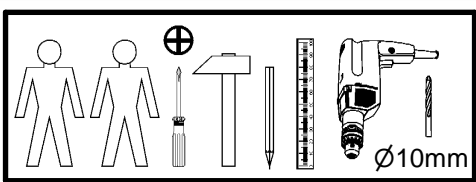
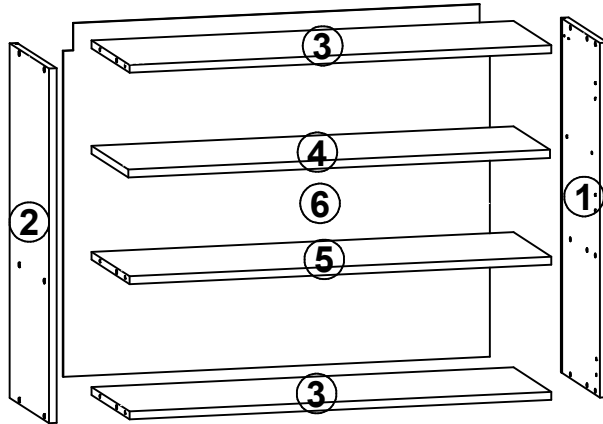
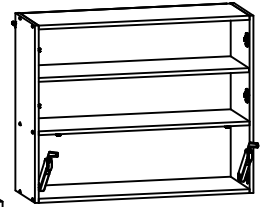

6x a64	6x b9	4x $\phi 8 \times 17$ mm d3	12x $\phi 7 \times 50$ mm e1	12x $\phi 6,3 \times 13$ mm e2	4x $\phi 6,3 \times 13$ mm e5	6x $\phi 8 \times 30$ mm f1	4x $\phi 10 \times 50$ mm f35	6x M4x12 mm j45\1
3x j45\2	25x l1	2x m44\1	2x m44\2	2x m44\3	2x m44\4	1x m44\6	2x n10	2x n9
6x silikon o21	4x $\phi 5 \times 60$ mm p17	3x $\phi 3,5 \times 20$ mm p20	4x $\phi 4 \times 30$ mm p21	4x $\phi 4 \times 13$ mm p28	12x $\phi 3,5 \times 15$ mm p51	1x z1		

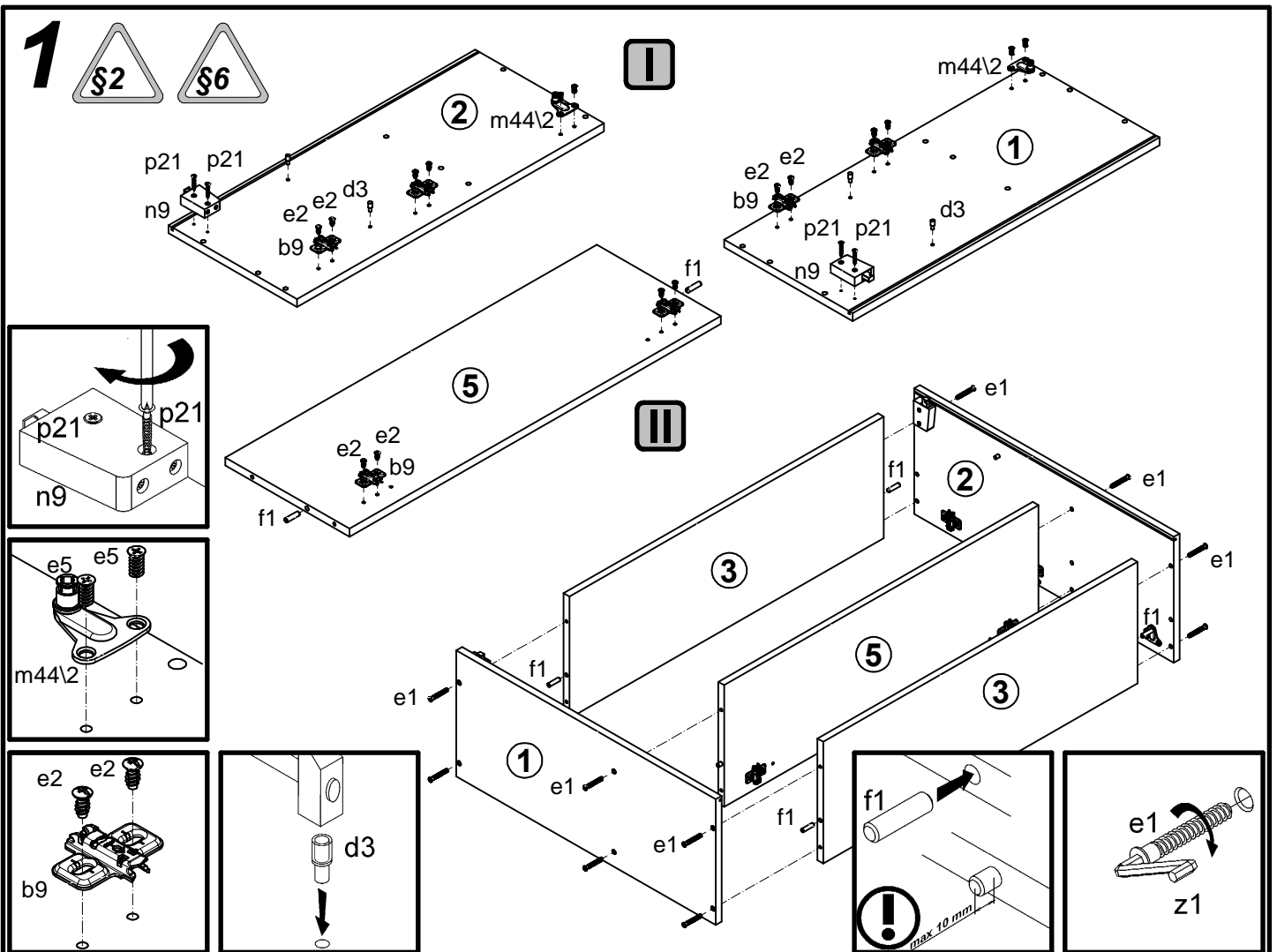

# 2

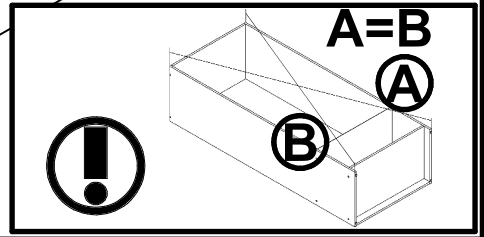
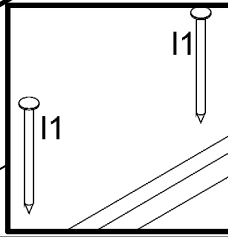
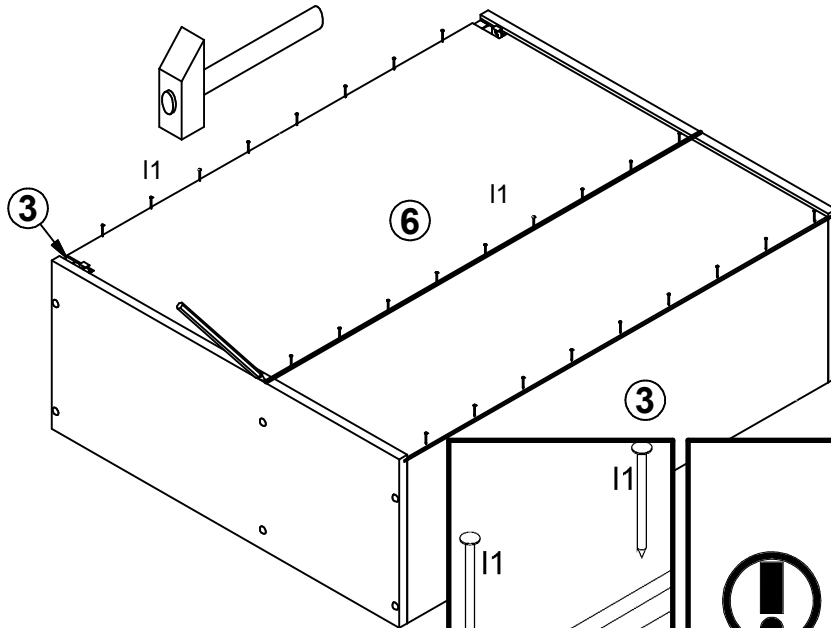
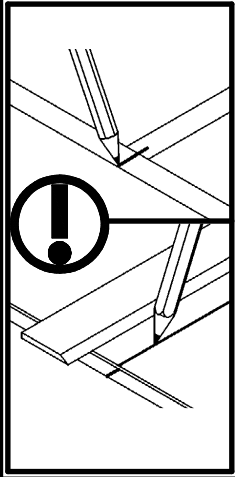

# 3

