

A	B	C	D	
1	K38-1007	1965	320	1/5
2	K38-1008	1965	320	1/5
3	K38-3009	262	318	1/5
4	K38-3010	262	318	1/5
5	K38-3011	262	283	3/5, 4/5
6	K38-4022	1928	262	2/5

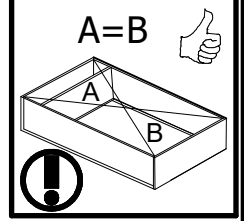

I

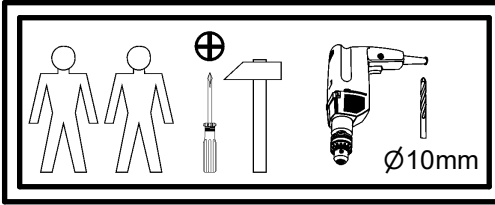
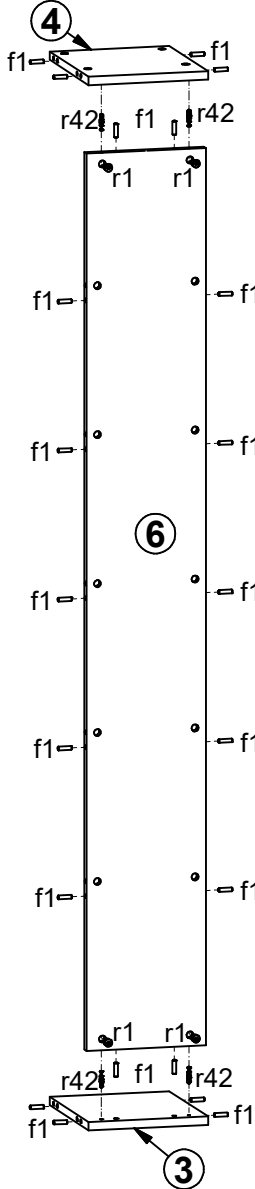

II

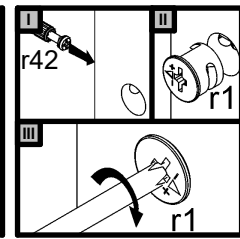
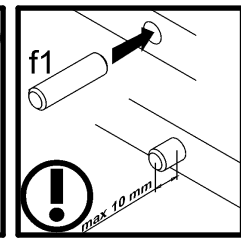
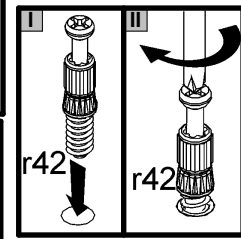
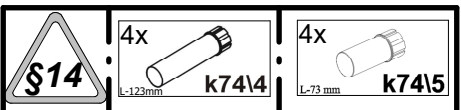
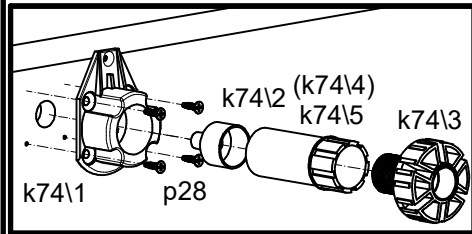
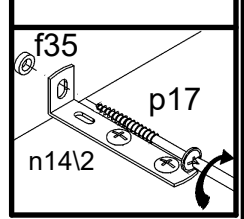
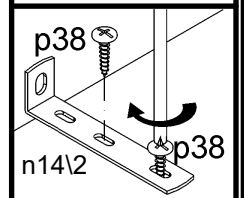
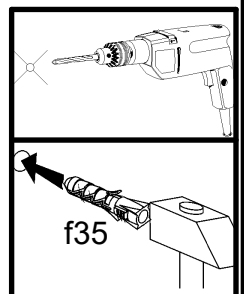
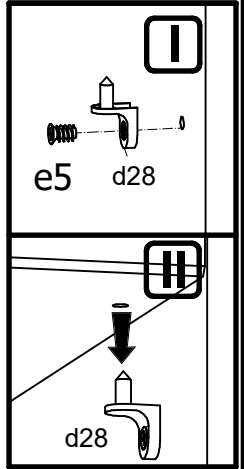
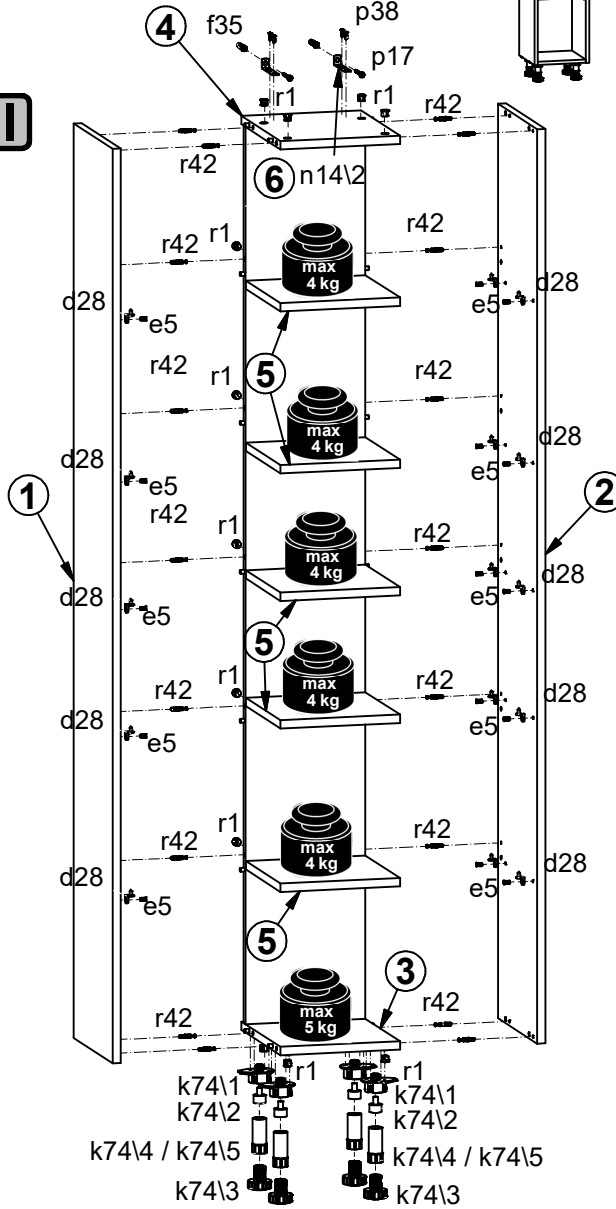

20x d28	20x Ø6.3x13 mm e5	22x Ø8x30 mm f1	4x k74/1	4x k74/2	4x k74/3	16x Ø4x13 mm p28	22x Ø15x12 mm #16 r1	22x 20/11 r42
2x n14/2	4x Ø3.5x16 mm p38	2x Ø10x50 mm f35	2x Ø5x60 mm p17	3x Ø5x23 mm j45/2	6x M4x12 mm j45/1	2x k66/4	4x Ø3.5x13 mm p1	