

A

K38-RB-LAM-DREG-60/126/32

A	B	C	D	
1	K38-1015	1263	320	1/4
2	K38-1016	1263	320	1/4
3	K38-3004	562	318	1/4
4	K38-3005	562	318	1/4
5	K38-3006	562	283	3/4
6	K38-4025	1226	562	2/4

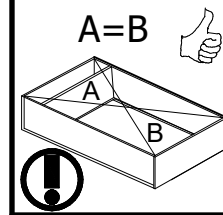
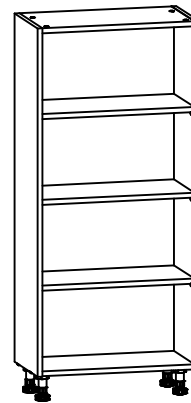
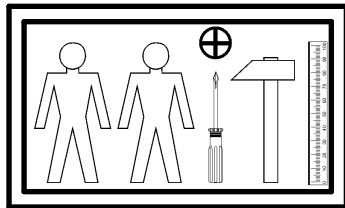

I

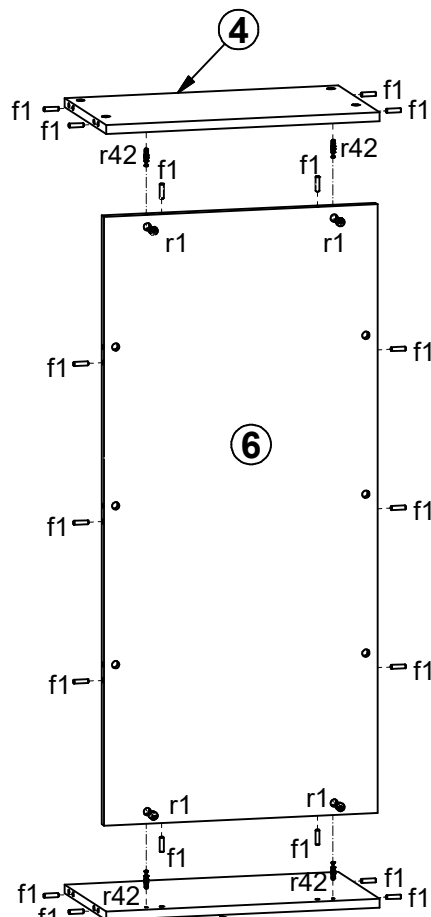

II

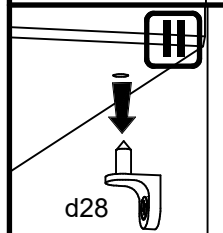
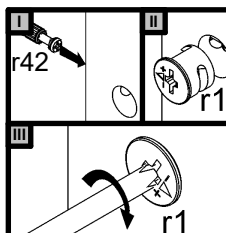
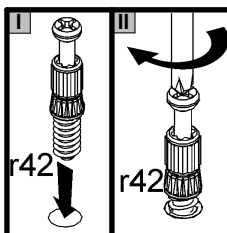
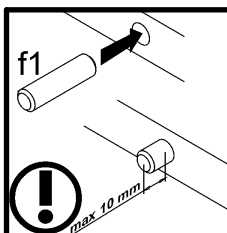
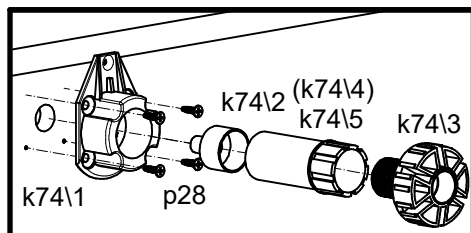
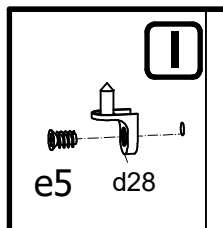
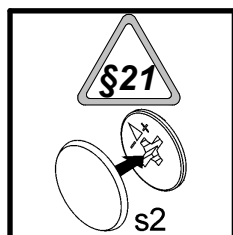
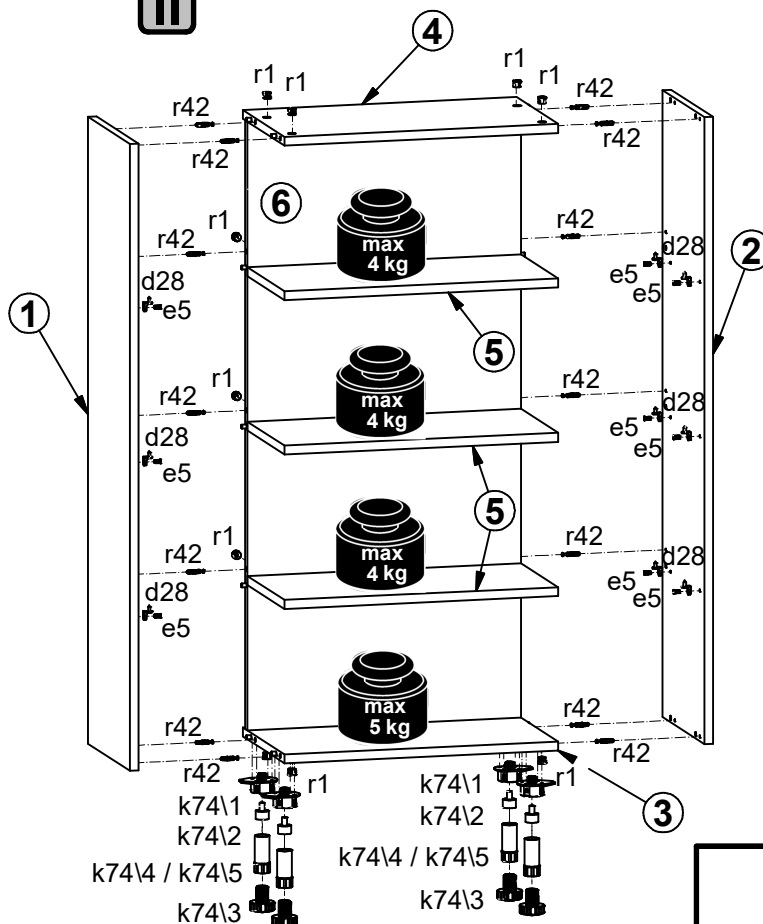

12x d28	12x e5 Ø6.3x13 mm	18x f1 Ø8x30 mm	4x k74\1	4x k74\2	4x k74\3	16x p28 Ø4x13 mm		4x k74\4 L-123mm
18x r1 Ø15x12 mm #16	18x r42 20/11	3x j45\2 Ø5x23 mm	6x j45\1 M4x12 mm	2x k66\4	4x p1 Ø3.5x13 mm	4x s2 Ø16		4x k74\5 L-73 mm