

**A**

**K38-RB-LAM-DREG-60/72/32**

A	B	C	D
1	K38-1031	719	320
2	K38-1032	719	320
3	K38-3004	562	318
4	K38-3005	562	318
5	K38-3006	562	283
6	K38-4020	682	562

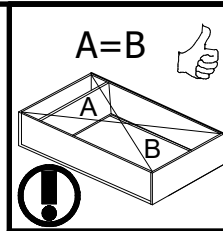

**I**

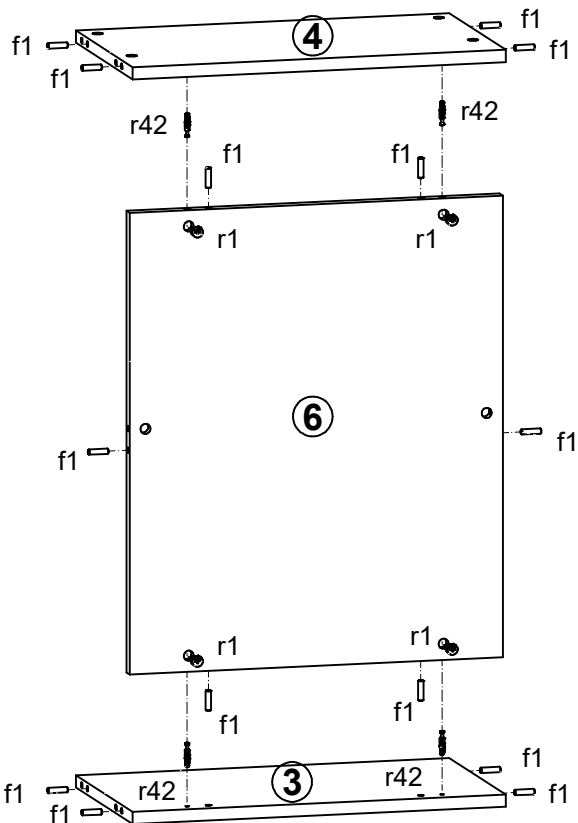

**II**

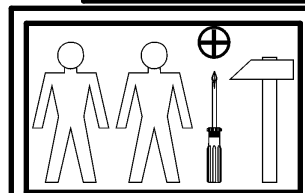
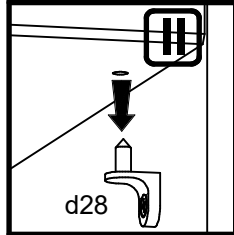
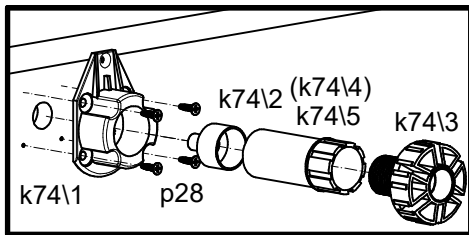
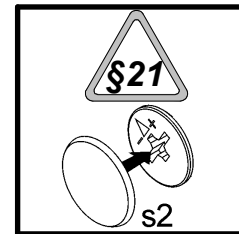
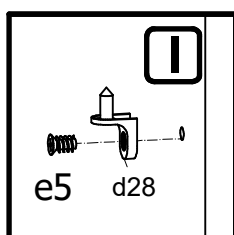
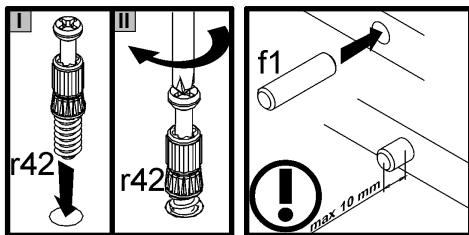
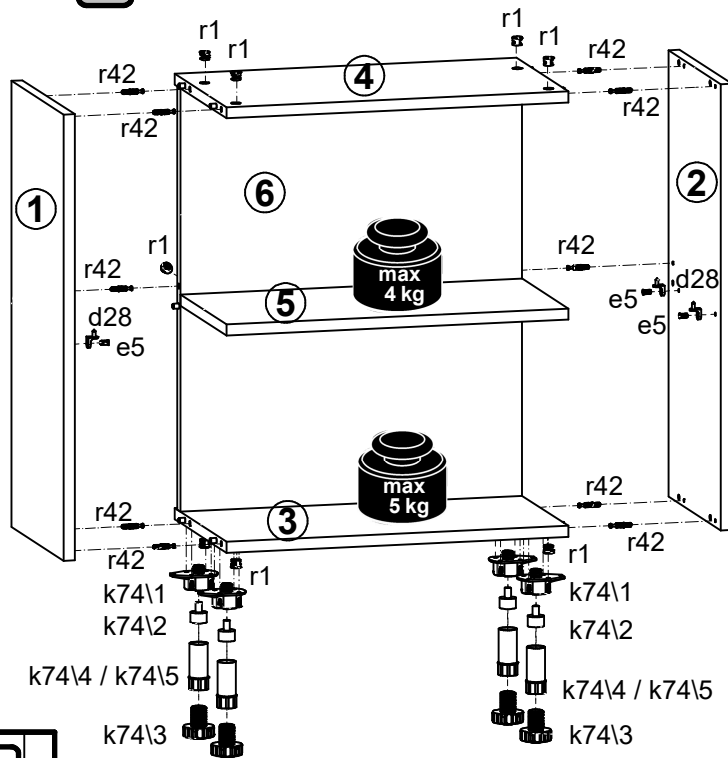

4x d28	4x Ø6.3x13 mm e5	14x Ø8x30 mm f1	4x k741	4x k742	4x k743	16x Ø4x13 mm p28		4x L-123mm k744
14x Ø15x12 mm #16 r1	14x 20/11 r42	3x Ø5x23 mm j45/2	6x M4x12 mm j45/1	2x k66/4	4x Ø3.5x13 mm p1	4x Ø16 s2		4x L-73 mm k745