

A

K38-RB-LAM-GREG-60/95/32

A	B	C	D
1	K38-1037	945	320
2	K38-1038	945	320
3	K38-3005	562	318
4	K38-3006	562	283
5	K38-4030	908	562

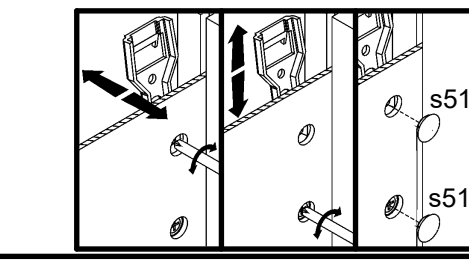
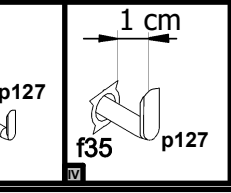
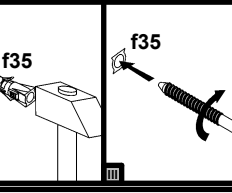
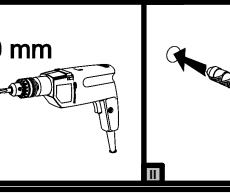
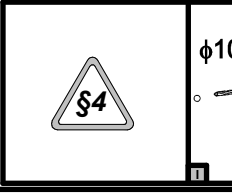
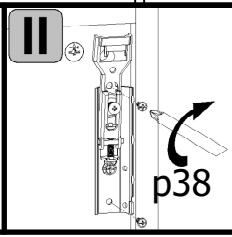
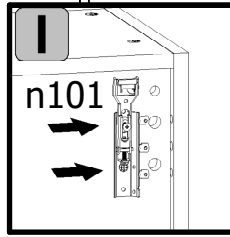
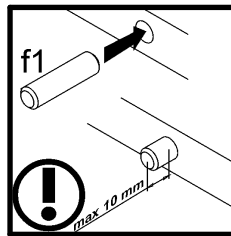
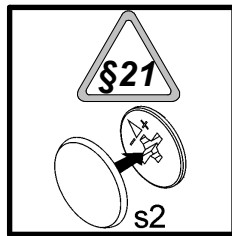
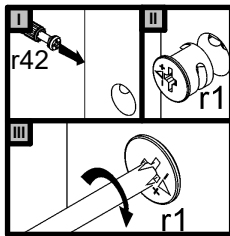
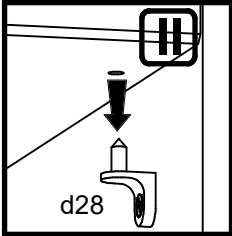
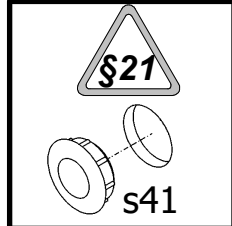
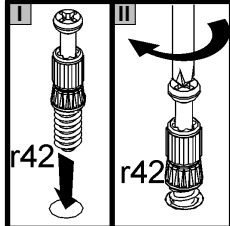
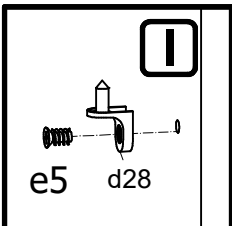
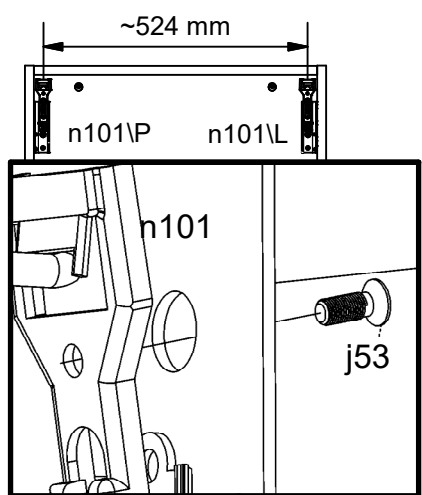
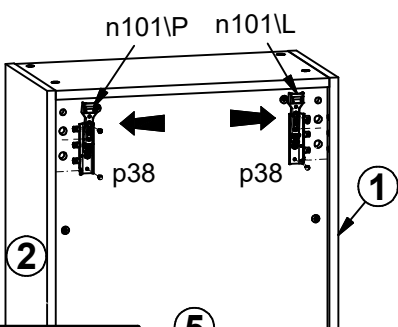
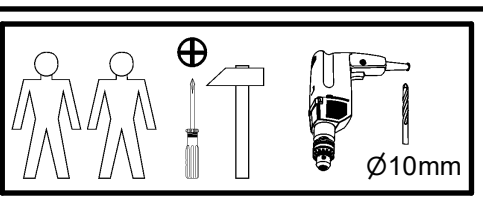
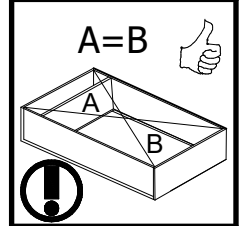
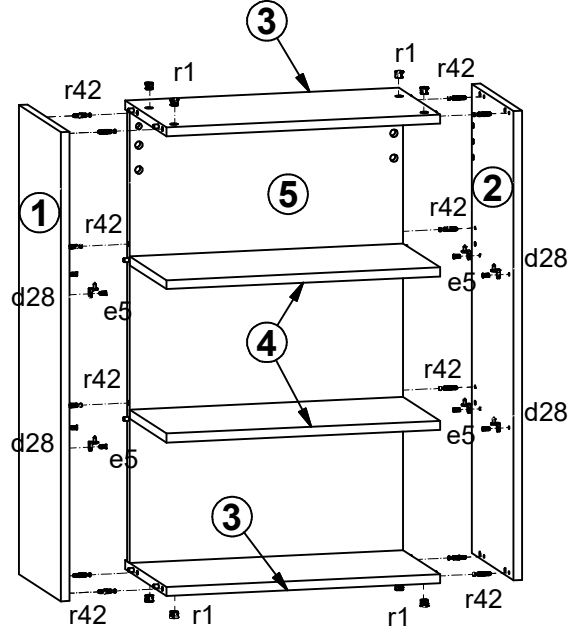
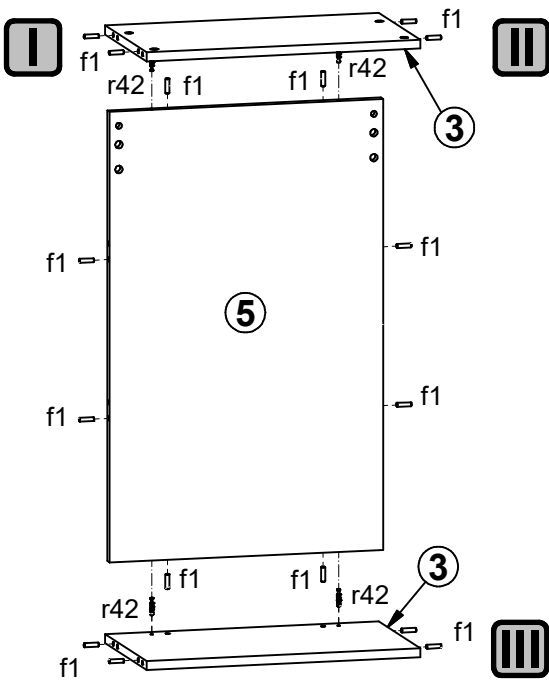
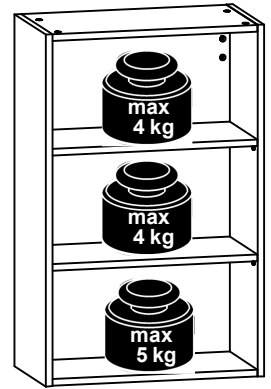

8x d28	8x Ø6.3x13 mm e5	16x Ø8x30 mm f1	1x n101/L	1x n101/P	4x Ø3.5x16 mm p38	16x Ø15x12 mm #16 r1	16x 20/11 r42	2x Ø10x50 mm f35
2x Ø6x60 mm p127	6x M4x12 mm j45/1	3x Ø5x23 mm j45/2	2x M4x25 mm j53			4x Ø16 s2	2x Ø12x4 mm s41	4x Ø15 s51