

INSTRUKCJA MONTAŻU SZUFLADA-ST-W/1196/500

A	B	C
1	QS1-3342	478 1092

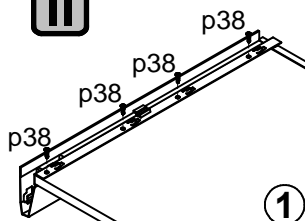

1

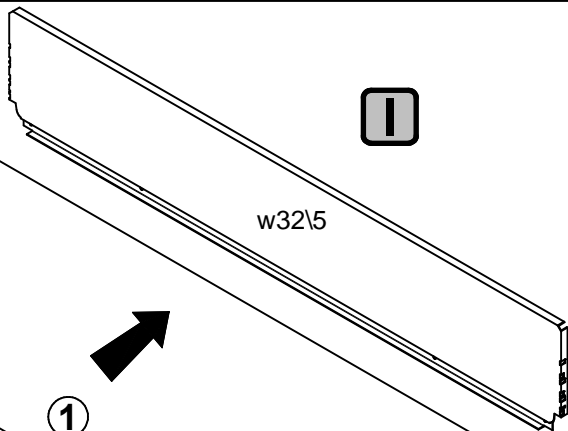
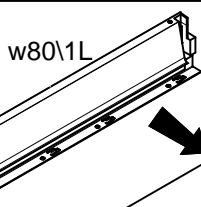
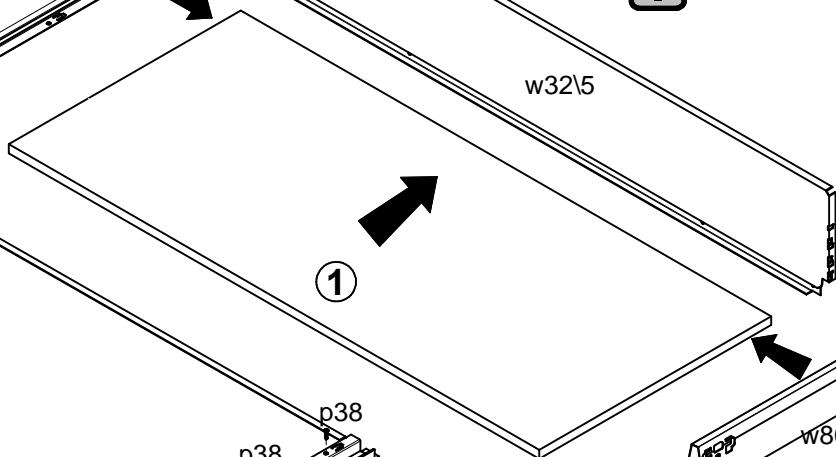

1

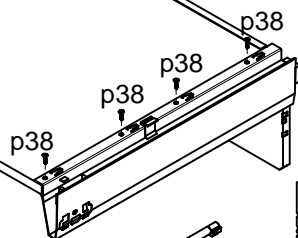
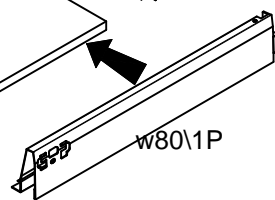

w35\2

w33\2

w80\1L

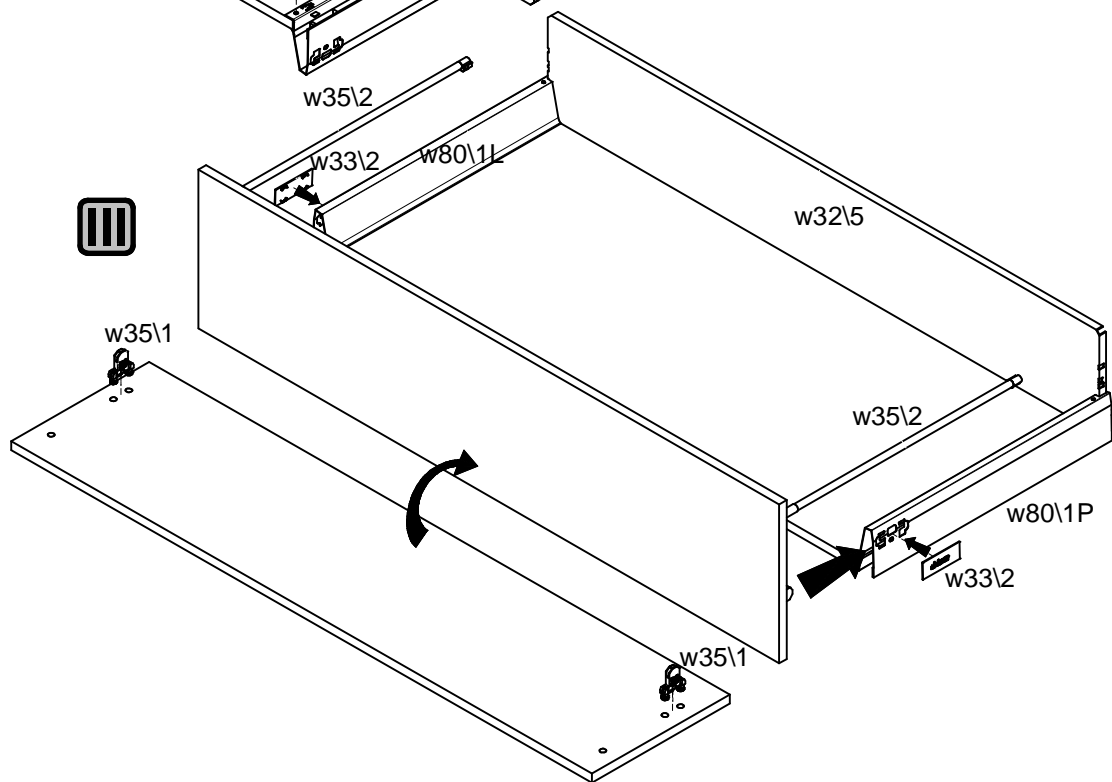

w32\5

w35\2

w80\1P

w33\2

w35\1

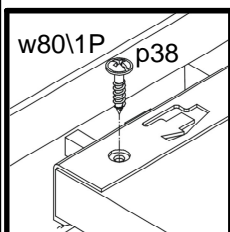
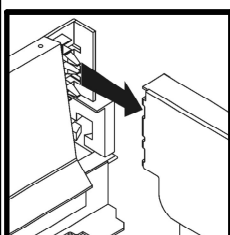

w80\1P

p38

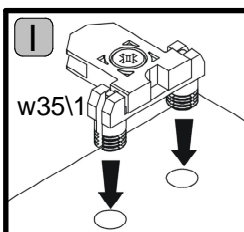

w35\1

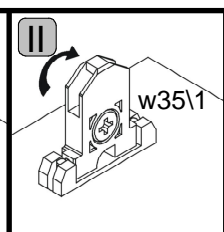

w35\1

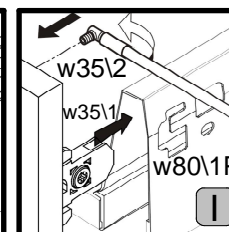
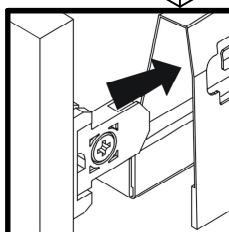

w35\2

w35\1

w80\1P

I

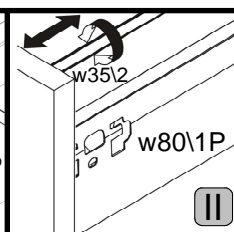

w35\2

w80\1P

II

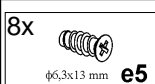

8x

φ6,3x13 mm

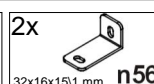

2x

32x16x15\1 mm

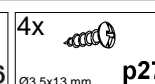

4x

Ø3,5x13 mm

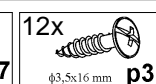

12x

φ3,5x16 mm



1x

L=500 (50 kg)

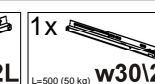

1x

L=500 (50 kg)

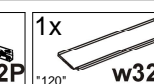

1x

"120"

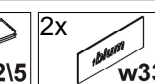

2x

w33\2

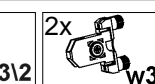

2x

w35\1



2x



2x

w35\3



1x

w80\1L

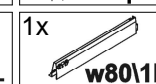

1x

w80\1P

