

**INSTRUKCJA MONTAŻU
FITTING-UP INSTRUCTION
AUFBAUANLEITUNG**

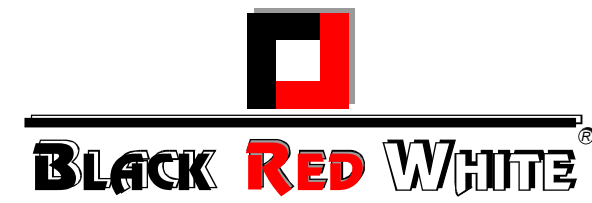

“STOLIK 70/57”

Producent:
BLACK RED WHITE S.A.
UL. KRZESZOWSKA 63
23-400 BILGORAJ



INSTRUKCJA MONTAŻU
FITTING-UP INSTRUCTION
AUFBAUANLEITUNG

STOLIK 70/57

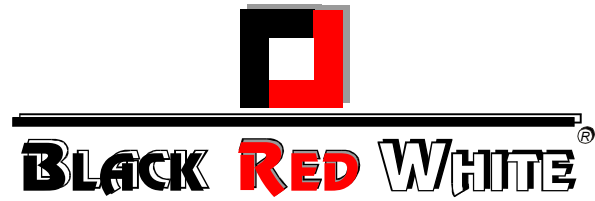

NR 1.

Obustronnie nawiercony
Bilaterally drilled
Beidseitig gebohrt

3 2szt.
2Art.
2Stck.

2 1szt.
1Art.
1Stck.

1 1szt.
1Art.
1Stck.

Symbol elementu Element symbol Elementeszeichen	Wymiary Measurements Ausmaß	Kod Code Kode
1	680x680	SO1-219
2	550x500	SO1-104
3	550x239	SO1-103

Aksesoria/Accessories/Zubehör

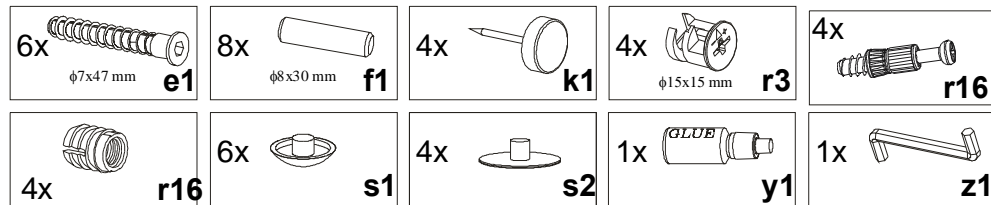

Do montażu potrzebne są:
You need for fitting-up:
Zur Montage werden Sie brauchen:

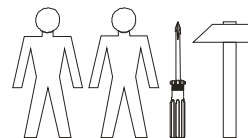

INSTRUKCJA MONTAŻU
FITTING-UP INSTRUCTION
AUFBAUANLEITUNG

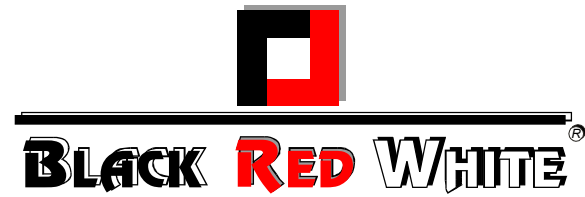

STOLIK 70/57

Producent:
BLACK RED WHITE S.A.
UL. KRZESZOWSKA 63
23-400 BIŁGORAJ

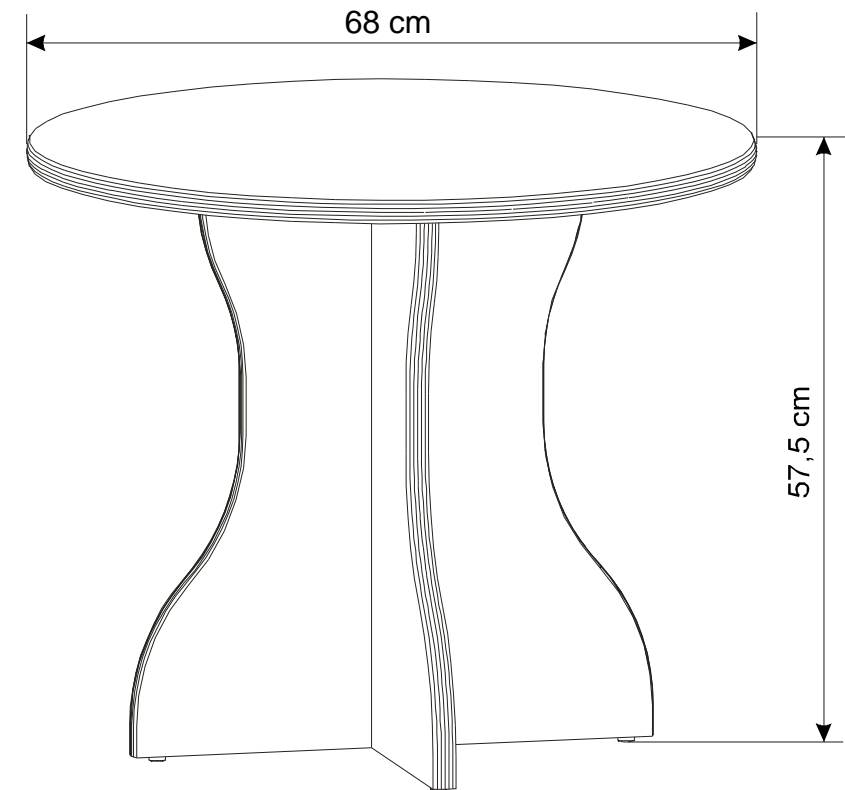

Podczas montażu
postępować
zgodnie z instrukcją.

While assembling
follow
the instruction.

Montage laut
der Aufbauanleitung
durchführen.

Podczas montażu
postępować
zgodnie z instrukcją.

While assembling
follow
the instruction.

Montage laut
der Aufbauanleitung
durchführen.

3 stolik 70/57

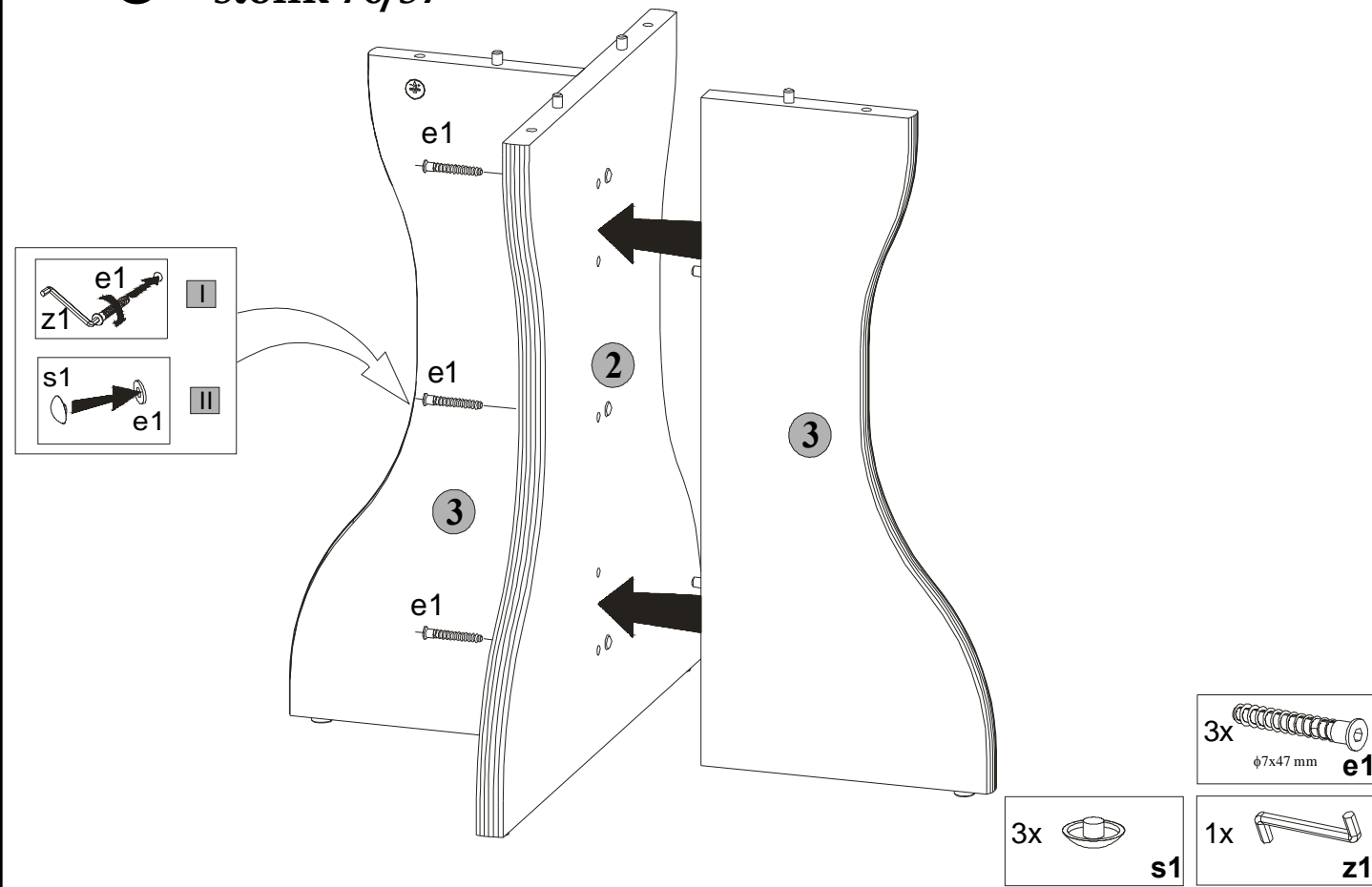

1 stolik 70/57

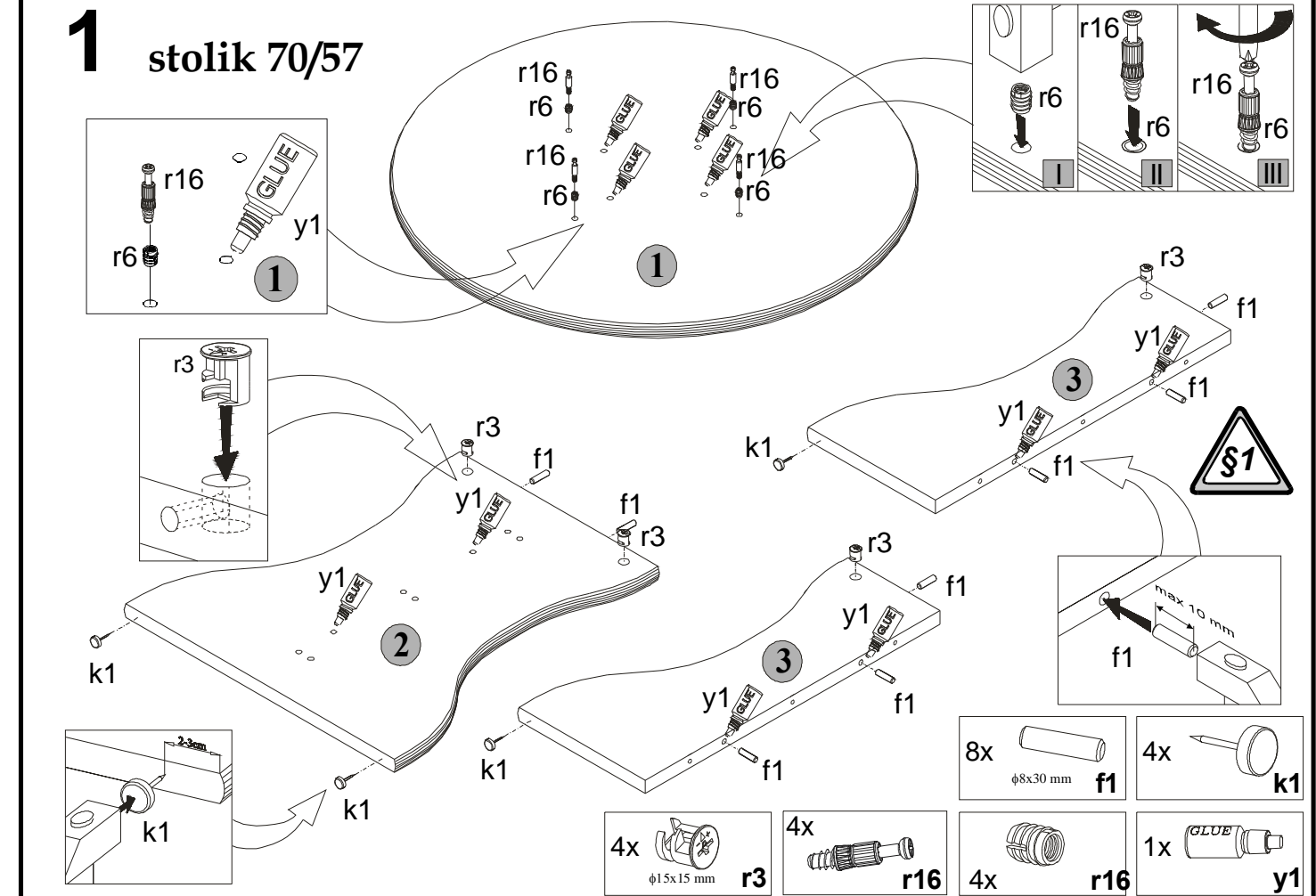

4 stolik 70/57

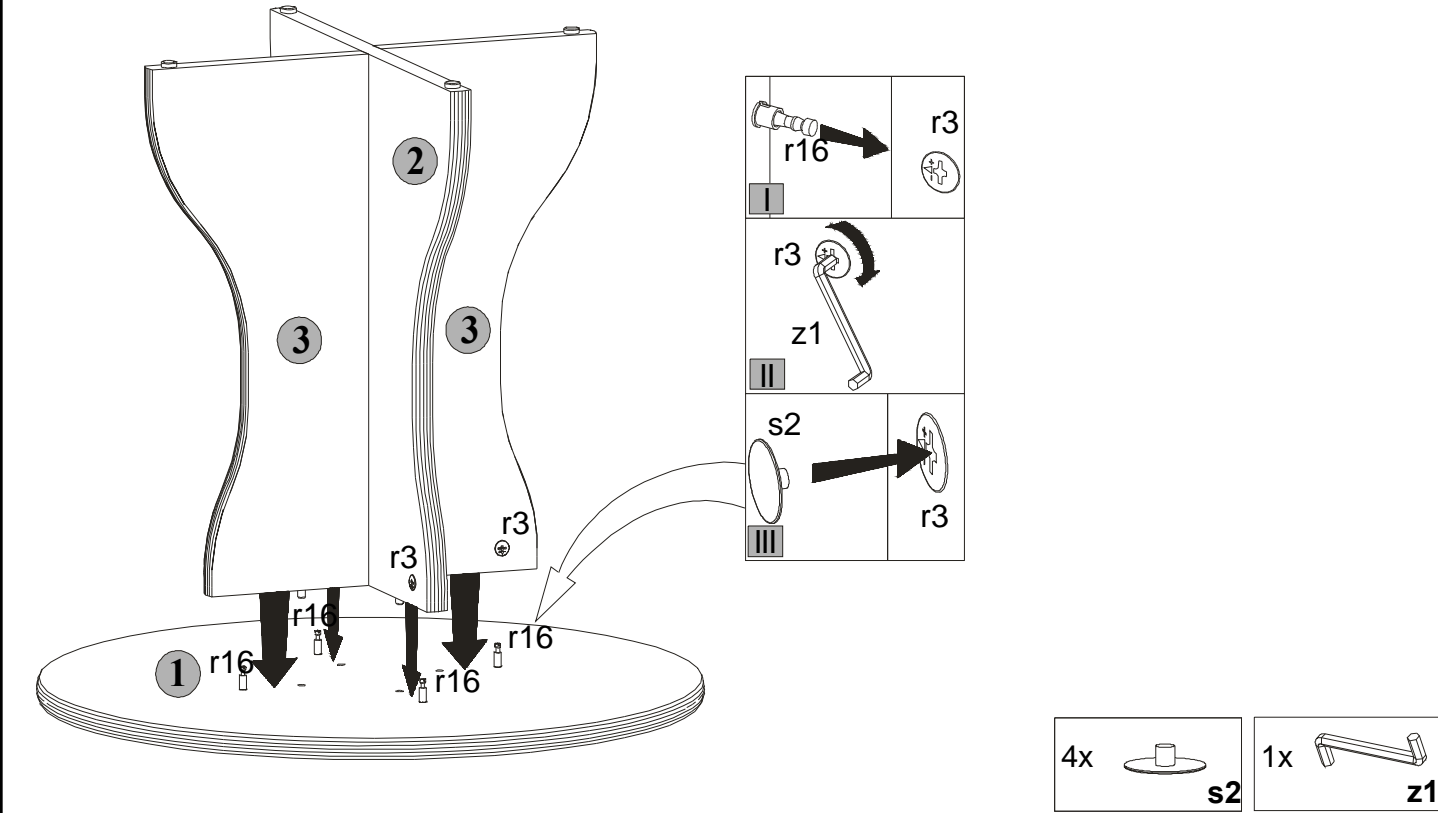

2 stolik 70/57

